

PRODUCT & SERVICES e-catalogue 2011

“We care for your care”



Welcome to the Aidacare e-catalogue, we have optimised the electronic version of our catalogue to make it easy than ever before to find the product/s you are looking for.

A few helpful hints:

1. Our Product Index pages contains links to the relevant sections of our catalogue, simply hover over the sub-category of interest and click the link.
2. At the bottom of each of our product pages you will find a thumbnail image of our Product Index page, by clicking this link you will be directed back the index page to begin your next product search.
3. You can use Adobe's find function to search our entire catalogue, simply hold down control f to begin your search

© Copyright Aidacare Pty Ltd 2011 Version 1.0

No part of this catalogue may be copied, distributed, reproduced, scanned or stored on any electronic database, whether in whole or in part in any form or by any means.

Aidacare Locations

VICTORIA

Brunswick East

82 Albion Street, Brunswick East 3057
Tel (03) 9981 2100 Fax (03) 9384 2088

Cheltenham

313 Warrigal Road, Cheltenham 3192
Tel (03) 9584 1644 Fax (03) 9584 0562

Geelong

74-76 Fyans Street, Geelong 3220
Tel (03) 5223 2263 Fax (03) 5223 2269

Bendigo

51 Bridge Street, Bendigo 3550
Tel (03) 5441 8213 Fax (03) 5441 7762

QUEENSLAND

Algerter

3/47 Learoyd Road, Algerter 4115
Tel (07) 3086 2900 Fax (07) 3272 4930

Ashmore

Shop 10, 353-357 Southport Nerang Rd,
Ashmore 4214
Tel (07) 5564 5650 Fax (07) 5539 1820

SOUTH AUSTRALIA

Glandore

664 South Road, Glandore 5037
Tel (08) 8293 1255 Fax (08) 8293 1766

NEW SOUTH WALES/ACT

Ingleburn

4 Noonan Place, Ingleburn 2565
Tel (02) 8706 2300 Fax (02) 9618 5111

Northmead

9/175 Briens Road, Northmead 2152
Tel (02) 8706 2330 Fax (02) 9890 8711

Albury

347 Urana Road, Lavington 2641
Tel (02) 6040 3444 Fax (02) 6040 3222

Tamworth

3/248 Peel St, Tamworth 2340
Tel (02) 6761 2018 Fax (02) 6761 2090

Orange

Mobile 0437 134 295

Canberra/Wagga

Mobile 0401 197 307

TASMANIA

Kingston

18 Mertonvale Circuit, Kingston 7050
Tel (03) 6229 4733 Fax (03) 6229 3676

Launceston

Unit 1/213 Wellington Street, Launceston
7250
Tel (03) 6229 4733 Fax (03) 6334 8922

Call our national phone
number **1300 133 120**
(local call cost only) to be
automatically diverted to
your local store.

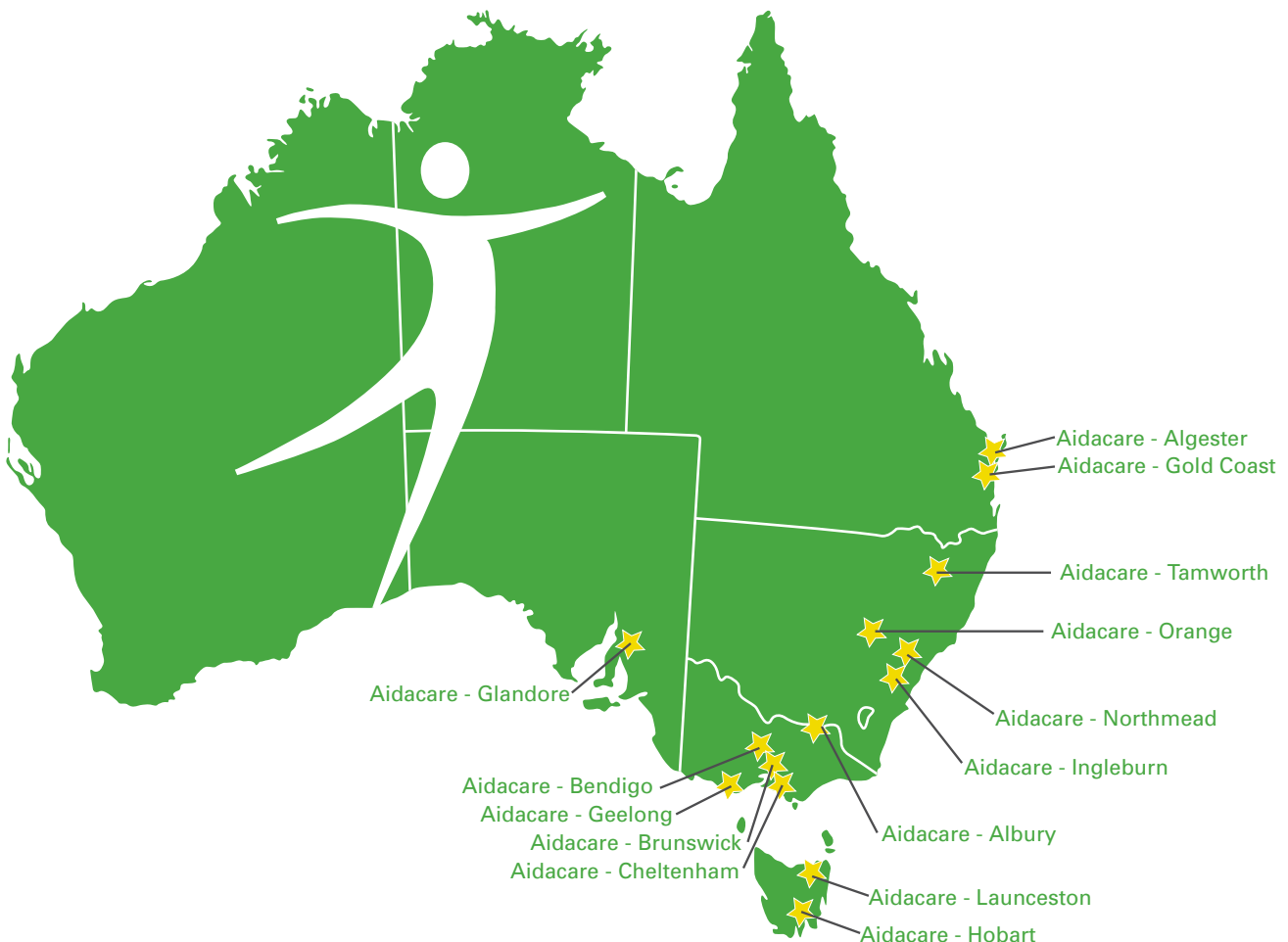

Catalogue Overveiw

- About Aidacare pg 02
- Product Index pg 03
- Aidcare Services
 - DVA: How Prescribers Work with Aidacare pg 05
 - DVA: Authorised Reseller Partners (Current as of 31/07/2011)..... pg 06
 - DVA: RAP Ordering Guidelines pg 07
 - DVA: Home Modifications..... pg 10
 - Aidacare Online..... pg 12
 - Customised & Specialised Equipment (C.A.S.E) pg 13
 - Equipment Rental pg 14
 - Repairs & Maintenance..... pg 16
 - Facility Services: New Fit-outs..... pg 17
 - Facility Services: Preventative Maintenance..... pg 18
 - Retail Showrooms pg 19
 - Home & Community Care..... pg 20

Aidacare strives to deliver INDUSTRY BEST standards in Equipment and Services. We work tirelessly with our network partners to improve and update our systems. If you identify any errors or omissions in this catalogue please let us know by emailing us on: catalogue@aidacare.com.au
We appreciate your input and partnership.

About Aidacare

Aidacare is one of the leading providers of ward-based equipment and rehabilitation products to aged care facilities, hospitals, physio and occupational therapists and private retail clients in Australia. We are proud to be a contracted supplier to major public funding bodies and insurers including DVA, TAC, DES, MASS as well as servicing major customers such as ENABLE, SWEP & CES.





Bariatric P 022

What is Bariatric Equipment.....	023	Mobility Scooters.....	025
Bathroom & Toilet.....	023	Ramps.....	026
Bedroom.....	024	Walking Frams & Aids - Mobility.....	026
Chairs - Therapeutic.....	025	Ward & Clinic.....	026
Manual Handling - Lifters & Slings.....	025	Wheelchairs & Seating - Mobility.....	026

Bathroom & Toilet P 028

K Care Shower Commodes.....	029	Other - Shower.....	053
Otto Bock Shower Commodes.....	039	Over Toilet Aids.....	056
Bed Pans & Urinals.....	044	Other - Toilet.....	058
Shower Seating.....	045	Grab Rails.....	060
Transfer Aids.....	050		

Bedroom P 064

Folding Beds & Accessories.....	065	Bedside Cabinets.....	087
Facility / Hospital Beds & Accessories.....	066	Bedside Commodes.....	088
Bed Sticks / Bed Poles & Other Accessories.....	071	Falls Prevention & Alarms.....	090
Overbed Tables.....	074		
Pillows & Supports.....	075		
Mattress Overview.....	078		

Chairs - Therapeutic P 092

Chairs - Day / Utility / Hi Lite.....	093	Chairs - Pressure Relief.....	102
Chairs - Powerlift & Recline.....	098	Chairs / Couches - Waiting Room.....	104
Chairs - Manual Recline.....	101	General Accessories.....	106

Continence P 108

Bedding Protectors.....	109	Clothing Protectors - Disposable.....	111
Chair Protectors.....	110	Clothing Protectors - Reusable.....	113

Daily Living Aids P 116

Dressing Aids.....	117	Crockery.....	126
Kitchen Aids.....	119	Reaching Aids.....	128
Gripping & Turning Aids.....	120	General Household Aids.....	129
Cutlery.....	122		

Laundry & Cleaning P 130

Linen Trolleys.....	131	Cleaning.....	134
Clean Linen/Storage.....	132		

Manual Handling - Lifters & Slings P 136

Lifters & Slings Overview.....	137	Oxford Lifters.....	144
Kerry Lifters.....	138	Oxford Lifter Accessories.....	146
Kerry Lifter Accessories.....	140	Oxford Slings.....	146
Kerry Slings.....	141	Specialty Lifters.....	147



Manual Handling - Other		P 150	
Transfer Boards	151	Transfer Walk Belts.....	152
Mobility Scooters		P 154	
Mobility Scooters.....	155	Scooters Accessories.....	160
Scooter Servicing.....	159		
Paediatric		P 162	
Strollers & Walking Frames.....	163	Other	167
Seating & Standing Aids.....	165	Paediatric Cots.....	168
Pressure Care & Circulation		P 170	
Protection - General.....	171	Compression - Lymphoedema	206
Protection - Hip.....	176	Donning & Doffing Aids..... (Refer pg 117)	
Protection - Skin & Limb.....	179	Alternating Air Mattresses..... (Refer pg 078)	
Protection - Waterproof.....	182	Pressure Relief Chairs	(Refer pg 102)
Compression - Legwear	184	Pressure Relief Cushions	(Refer pg 346)
Compression - Arm & Hand.....	200		
Ramps		P 210	
Modular & Rubber Ramps.....	211	Custom Ramps..... (Refer pg 10)	
Therapy & Exercise		P 214	
Exercise & Resistance Training.....	215	Bracing & Supports - Wrist & Hand	246
Physiotherapy - Other.....	221	Bracing & Supports - Knee	262
Enteral Feeding Pumps & Accessories	225	Bracing & Supports - Calf & Thigh.....	274
Bracing & Supports - Neck & Shoulder.....	228	Bracing & Supports - Ankle.....	276
Bracing & Supports - Rib & Abdomen	232	Bracing & Supports - Foot & Toe	282
Bracing & Supports - Back Support	233	Bracing & Supports - Male Support.....	290
Bracing & Supports - Arm & Elbow	240		
Walking Frames & Aids - Mobility		P 294	
Seat Walkers/Rollators & Accessories	295	Crutches & Accessories	301
Walking Sticks & Accessories	299	General Accessories.....	303
Ward & Clinic		P 304	
Medicine / Flexi Carts.....	305	Instrument Trolleys.....	313
Medicine / Flexi Carts Options	307	Ward Equipment.....	315
GP/Physio Room Equipment.....	310	Patient Response Trolleys	318
Kitchen Trolleys	312	Weigh Chairs & Scales	319
Wheelchairs & Seating - Mobility		P 320	
Basic Manual Wheelchairs	321	Wheelchair Cushion - Overview	346
Custom Manual Wheelchair - Overview.....	323	Wheelchair Backrests.....	363
Power Wheelchair - Overview.....	335	Wheelchair Accessories - General.....	369

DVA: How Do Prescribers Work with Aidacare?



Aidacare offers a service to Prescribers & DVA that is based on the key philosophy that we listen and respond to our network of prescribers to provide the highest possible customer service to the individual veteran.

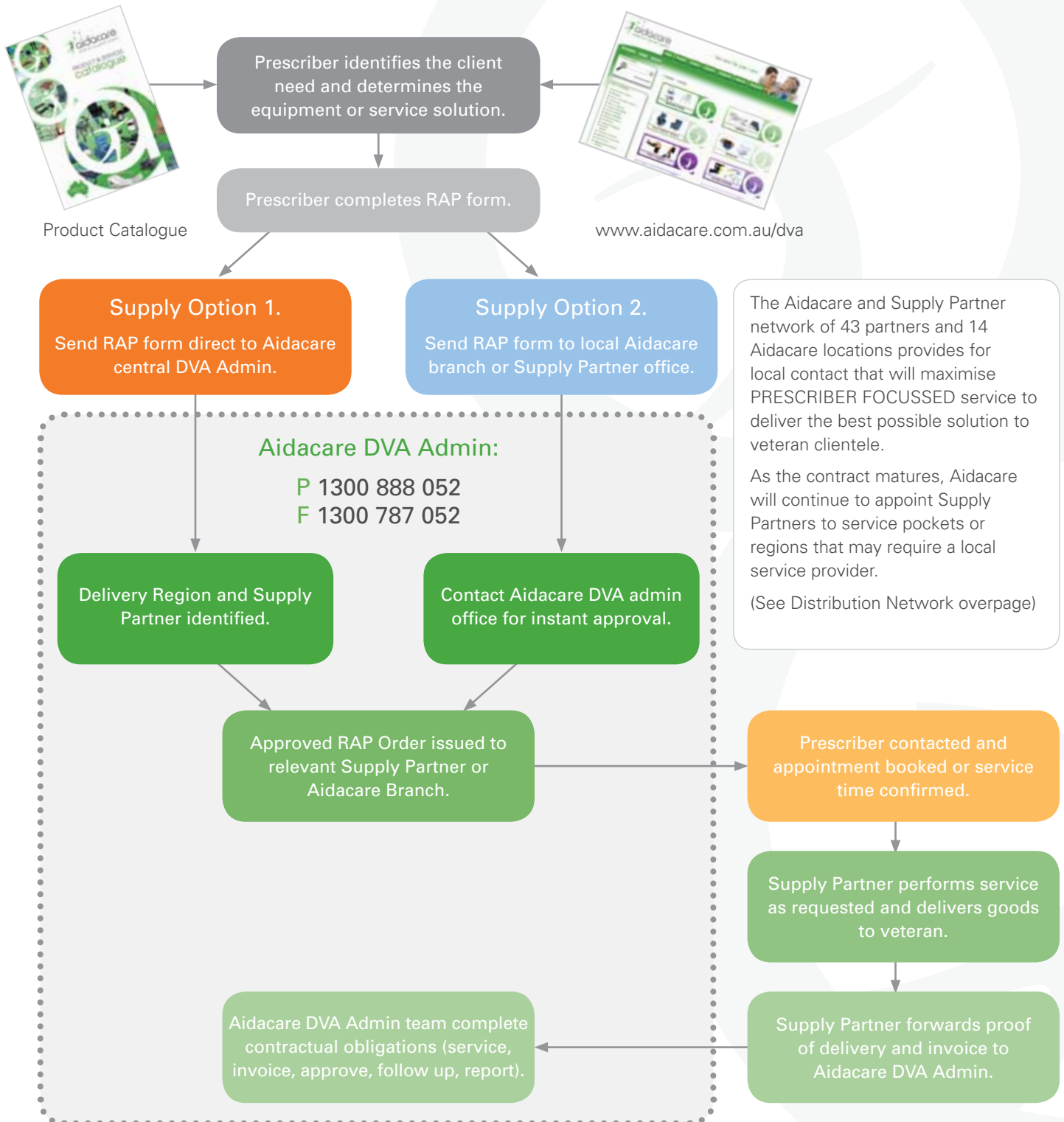

DVA: Authorised Reseller Partners



Aidacare's Distribution Network (Current as of 31/07/2011)

The Aidacare Supply Partner Network proposed in this tender submission provides for extensive reach into all areas of Australia.

A total of 46 Showrooms / Distribution points (14 Aidacare and 37 Supply Partner) located to be capable of servicing all major population bases, regional centres and remote areas.

All regional / remote located offices maintain extensive delivery networks utilising company delivery personnel and local courier services.

This submission is further supported by our alliance with the HireAHubby Commercial group with a network of some 500 sub-contractors positioned throughout Australia to complete Minor Home Modification tasks.

The above map details the Australia wide coverage of the Aidacare & Supply Partners network.

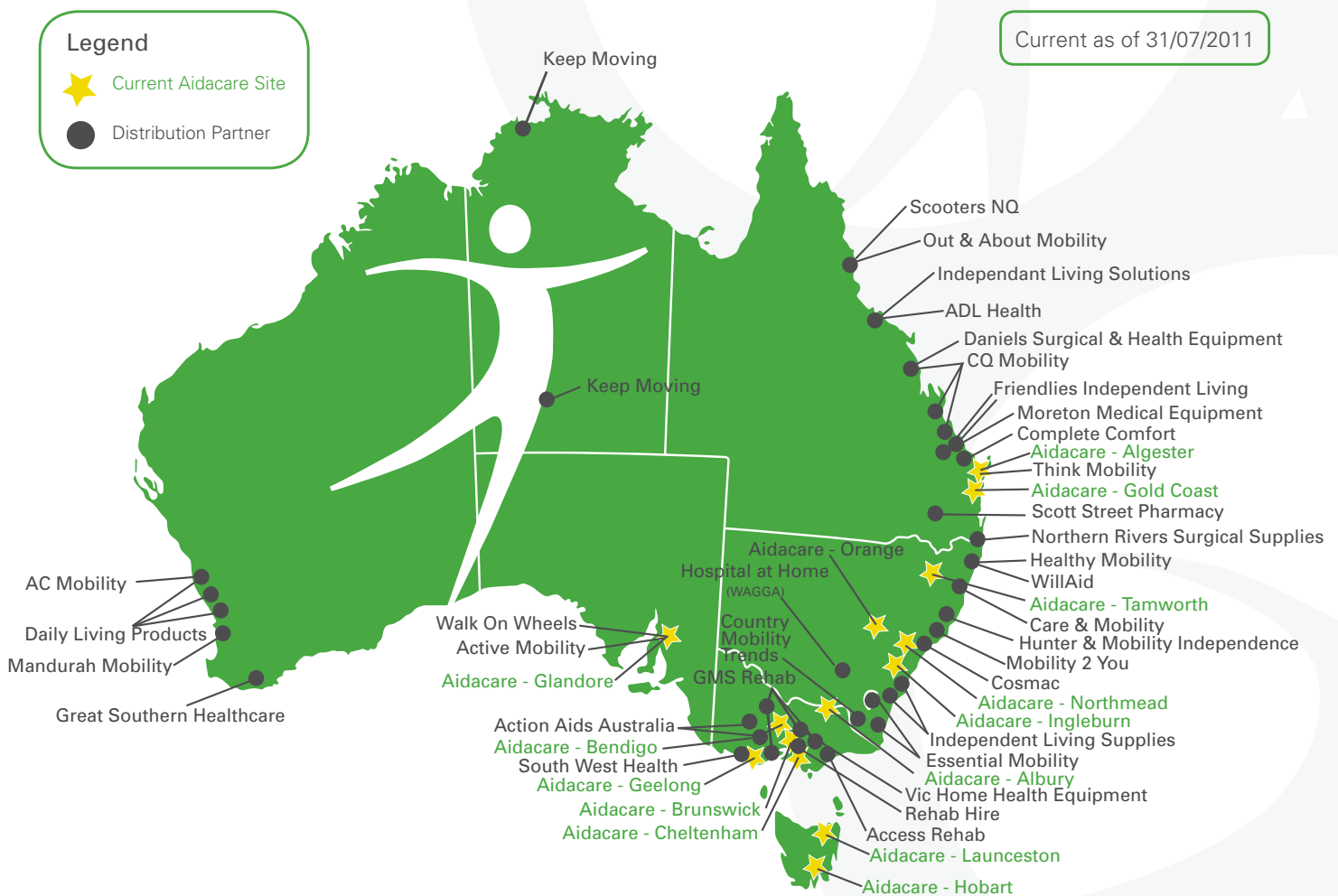

Visit www.aidacare.com.au/dva for Regional Reseller Partner contact details

PRODUCT INDEX



DVA Contact Details P 1300 888 052
F 1300 787 052
E dva@aidacare.com.au

General Enquiries P 1300 133 120
E admin@aidacare.com.au
W www.aidacare.com.au

DVA: Ordering Guidelines



RAP Code	Category	Prior Approval Required	Veteran Limit	Eligible Prescriber	Hivre or Buy
AA16	Pressure Alarms	No	2 every 2 yrs	OT/RN/Phys/LMO	Buy
AB01	Beds	Yes	1 per person	OT/RN/Phys/ LMO/S/Ch/Ost	HIRE
AB02	Bed Back Rests	No	2 every 5 yrs	OT/Phys/RN/LMO/S/Ch/Ost	Buy
AB03	Bed Blocks	No	9 blocks	OT/Phys/RN/LMO/S/Ch/Ost	Buy
AB06	Bed Cradles	No	1 every 5 yrs	OT/Phys/RN/LMO/S/Ch/Ost/Pod	Buy
AB07	Bed Ladders	No	1 every 5 yrs	OT/Phys/RN/LMO/S/Ch/Ost	Buy
AB08	Bed Sticks	No	1 every 5 yrs	OT/RN/Phys/ LMO/S/Ch/Ost	Buy
AB09	Bed Rails	No	1 every 5 yrs	OT/RN/Phys/ LMO/S/Ch/Ost	Buy
AB11	Sheepskin Rugs / Foot / Heel / Elbow Pads	No	8 items per yr	OT/Phys/RN/LMO/S/Pod/Ch/Ost	Buy
AB12	Monkey Bar / Self-Lifting Stand	No	1 every 5 yrs	OT/RN/Phys/LMO/S/Ch/Ost	HIRE
AB13	Table - Over Bed Add extra lines as needed	No	1 every 5 yrs	OT/Phys/RN/LMO/S/Ch/Ost	Buy
AB14	Pressure Care Mattress - Low-Risk Category	No	1 every two yrs	OT/Phys/RN/LMO/Pod/S/Ch/Ost	Buy
AB15	Pressure Care Mattress - High-Risk Category	Yes	1 every two yrs	OT/Phys/RN/LMO/S	HIRE
AB16	Replacement Parts / Repairs for AB items	Yes	Functional need	OT/Phys/RN/LMO/S/Ch/Ost/POD	Buy
AB17	Heel Elevators for Pressure Care- Beds / Bedding / Pressure Care	No	2 per yr	OT/Phys/RN/LMO/S/Pod	Buy
AB18	Bed Back Rest - Electrical	No	1 every 5 yrs	OT/Phys/RN/LMO/S/Ch/Ost	HIRE
AC01	Chair - Geriatric, High Backed	No	1 every 5 yrs	OT/Phys/RN/S/LMO/Ch/Ost	Buy
AC02	Chair - Geriatric, Low Backed	No	1 every 5 yrs	OT/Phys/RN/S/LMO/Ch/Ost	Buy
AC03	Stool - Height adjustable	No	1 every 5 yrs	OT/Phys/RN/S/LMO/Ch/Ost	Buy
AC04	Chair - Platform / Blocks	No	1 plat / 4 blks every 5 yrs	OT/Phys/RN/S/LMO/Ch/Ost	Buy
AC06	Chair - Electrically Operated Recliner	Yes	1 per person	OT/Phys/S/LMO/Ch/Ost	HIRE
AC07	Footstool - Height Adjustable	No	1 every 5 yrs	OT/Phys/RN/S/LMO/Ch/Ost	Buy
AC08	Chair - Fallout / Water	Yes	1 per person	OT/Phys/RN/S/LMO/Ch/Ost	HIRE
AC09	Chair - Manual Recliner	Yes	1 per person	OT/Phys/RN/S/LMO/Ch/Ost	HIRE
AC10	Replacement Parts / Repairs for AC items	Yes	Functional need	OT/Phys/RN/S/LMO/Ch/Ost	Buy
AE01	Back Supports (seating)	No	2 per yr	Phys/OT/Ch/Ost/RN/S/LMO	Buy
AE02	Bed Wedges and Supports	No	2 per yr	Phys/OT/RN/Ch/Ost/S/LMO	Buy
AE03	Neck Supports	No	2 per yr	OT/Phys/Ch/Ost/S/RN/LMO	Buy
AE04	Cushion - Pressure Care, High Level	No	2 per person	OT/Phys/RN/Ch/Ost/S/LMO	Buy
	Cushion - Pressure Care, High Level (Jay J2 / ROHO Quadro / Otto Cloud)	Yes	2 per person	OT/Phys/RN/Ch/Ost/S/LMO	Buy
AE05	Cushion - Pressure Care, Low Level	No	1 per person every 5 yrs	OT/Phys/Ch/Ost/RN/S/LMO	Buy
AE06	Replacement Parts / Repairs for AE items	Yes	Functional need	OT/Phys/Ch/Ost/RN/S/LMO	Buy
AH01	Crockery and Cutlery - Adaptive	No	2 per item type every 2 yrs	OT/RN/Phys/LMO/S	Buy
AH04	Book Holder	No	2 every 2 yrs	OT/ RN/Phys/LMO/S	Buy
AH06	Handle - Utensil	No	6 items per yr	OT/RN/Phys/LMO/S	Buy
AH07	Jar Opener	No	2 every 2 yrs	OT/ RN/Phys/LMO/S	Buy
AH08	Key Turner	No	4 per yr	OT/ RN/Phys/LMO/S	Buy
AH09	Non - Slip Table Mat	No	3 per yr	OT/ RN/Phys/LMO/S	Buy
AH11	Reaching Appliances - Long Handled Reacher	No	4 every 2 yrs	OT/ RN/Phys/LMO/S	Buy
AH12	Scissors - Spring Loaded Adaptive	No	2 every 2 yrs	OT/ RN/Phys/LMO/S	Buy
AH13	Tap Turner (see also AL00 Lever Taps)	No	4 every 2 yrs	OT/ RN/Phys/LMO/S	Buy
AH14	Traymobile - Height Adjustable	No	2 every 2 yrs	OT/ RN/Phys/LMO/S	Buy
AH15	Vegetable Board (kitchen cutting board) - Modified	No	2 every 2 yrs	OT/ RN/Phys/LMO/S	Buy
AH17	Eating/Kitchen/Household Adaptive Appliances - Miscellaneous Items	No	2 per item type every 2 yrs	OT/ RN/Phys/LMO/S	Buy
AH19	Shoe horn - Long handled	No	2 every 2 yrs	OT/ RN/Phys/LMO/S	Buy
AJ06	Footwear Temporary (including cast boots/shoes)	No	1 per limb (or pair) per yr	Pod/O/S/Phys/P/RN/LMO	Buy
AL04	Lever Taps	No	4 outlets	OT/S/LMO	Buy
AL05	Lifts (including stair lifts and water lifts)	Yes	1 per person	OT/S/LMO	Buy

DVA: Ordering Guidelines



RAP Code	Category	Prior Approval Required	Veteran Limit	Eligible Prescriber	Hire or Buy
AL06	Non-slip Surfaces	No	1 every 2 yrs	OT/S/LMO	Buy
AL09	Rails (internal and external)	No	Functional need	OT/S/LMO	Buy
AL10	Ramps (fixed)	Yes	Functional need	OT/S/LMO	Buy
AL11	Ramps - Portable	No	1 item per entrance	OT/S/LMO	Buy
AL14	Step Modification	No	Functional need	OT/S/LMO	Buy
AL15	Home Mods (Complex)	Yes	Functional need	OT/S/LMO	Buy
AL21	Home Mods (Minor)	Yes	Functional need	OT/S/LMO	Buy
AL22	Replacement Parts / Repairs for AL items	Yes	Functional need	OT/S/LMO	Buy
AM01	Hoist/Personal lifting device (includes sling)	Yes	1 per person	Phys/OT/RN/S/LMO	HIRE
AM02	Sling for Hoist - additional	Yes	1 per person	OT/Phys/RN/S/LMO	Buy
AM03	Replacement Parts / Repairs for AM items	Yes	Functional need	OT/Phys/RN/S/LMO	Buy
AP02	Scooter Batteries	No	2 per yr	OT/S/LMO	Buy
AP03	Crutches - Mobility Appliances	No	2 per person	Phys/OT/Ch/Ost/LMO/S	Buy
AP05	Mobility Scooter - Electric	Yes	1 per person	OT/S/LMO	HIRE
AP06	Quadstick / Quadrapod	No	2 every 5 yrs	Phys/OT/S/LMO	Buy
AP09	Transfer Equipment	No	6 every 5 yrs	Phys/OT/RN/S/LMO	Buy
AP12	Walking Frame	No	2 per person	Phys/OT/Ch/Ost/S/LMO	Buy
AP13	Walking Stick	No	2 every 5 yrs	Phys/OT/Ch/Ost/S/LMO	Buy
AP14	Wheelchair Accessories	No	1 every 5 yrs	Phys/OT/Ch/Ost/S/LMO	Buy
AP15	Walking Stick Holder / Strap	No	2 every 5 yrs	Phys/OT/Ch/Ost/LMO/S/RN	Buy
AP16	Wheelchair - Electric - power drive	Yes	1 per person	OT/S/LMO	HIRE
AP17	Wheelchair - Manual (standard)	Yes	1 per person	Phys/OT/S/Ch/Ost/LMO	HIRE
AP19	Wheelchair - Manual (customised)	Yes	1 per person	Phys/OT/S/LMO	HIRE
AP21	Replacement Parts / Repairs for AP items	Yes	Functional need	Phys/OT/S/Ch/Ost/LMO/RN	Buy
AP22	Walking Frame Accessories (seat, basket etc)	No	8 every 5 yrs	Phys/OT/S/Ch/Ost/LMO/RN	Buy
AR01	Ankle Supports (not custom-made)	No	3 per yr	Phys/Pod/S/Ch/Ost O/P/LMO	Buy
	Ankle Supports - Air Casts & Air Walker Boots & Custom-made	Yes	3 per yr	Phys/Pod/S/Ch/Ost O/P/LMO	Buy
AR02	Knee Supports/Braces (not custom-made)	No	3 per yr	Phys/S/Pod/Ch/Ost/O/P/LMO	Buy
	Knee Supports - Hinged ROM Braces	Yes	3 per yr	Phys/S/Pod/Ch/Ost/O/P/LMO	Buy
AR03	Upper Limb Supports/Braces (including tennis elbow brace), not custom-made	No	6 per yr	Phys/S/OT/P/O/Ch/Ost/LMO	Buy
	Upper Limb Supports/Braces - Progressive Elbow Splint	Yes	6 per yr	Phys/S/OT/P/O/Ch/Ost/LMO	Buy
AR04	Foot Orthoses (not custom-made)	No	1 pair per yr	Pod/Phys/S/P/O/Ch/Ost/LMO	Buy
AR08	Lumbar Braces / Back Brace / Lumbar Corset, not custom-made	No	2 per yr	Phys/S/Ch/Ost/OT/P/O/LMO	Buy
	Lumbar Orthoses - TLSO / LSO	Yes	2 per yr	Phys/S/Ch/Ost/OT/P/O/LMO	Buy
AR09	Scrotal Support, not custom-made	No	4 per yr	S,LMO/OT/Phys	Buy
AR14	Surgical Corsets (including belt/truss), not custom-made	No	4 per yr	S/LMO/RN/OT/Phys/Ch/Ost	Buy
AR18	Cervical Collars (see also AE00 Cushions / Supports), not custom-made	No	2 per yr	Phys/S/Ch/Ost/LMO/P/O	Buy
AR19	Ankle / Foot Orthoses (not custom-made)	No	2 per yr	Phys/Pod/S/Ch/Ost/OT/P/O/LMO	Buy
	Ankle / Foot Orthoses - Air Walker Boots	Yes	2 per yr	Phys/Pod/S/Ch/Ost/OT/P/O/LMO	Buy
AR22	Compression Garments (not custom-made)	No	3 pairs per 6 months	S/RN/Phys/OT/LMO	Buy
	Compression Garments - Lymphoedema & Ready-wrap Garments	Yes	3 pairs per 6 months	S/RN/Phys/OT/LMO	Buy
AR23	Lymphoedema Pump	Yes	1 per person	S/RN/Phys/OT/LMO	Buy
AR26	Lymphoedema Garment Consumables (glue/adhesive/spray)	No	2 every 2 yrs	S/RN/Phys/OT/LMO	Buy
AR27	Replacement Parts / Repairs for AR items	No	Functional need	Phys/S/Ch/Ost/OT/OST/LMO	
AR28	Hip Protectors (not custom-made)	No	6 per yr plus shields	RN/Phys/S/OT/LMO	Buy
AR29	Limb Protectors (not custom-made)	No	6 per yr	RN/Phys/S/OT/LMO	Buy
AS01	Blood Pressure Monitor (Sphygmomanometer or glucometer)	No	1 every 5 yrs	S/LMO,	Buy

DVA: Ordering Guidelines



RAP Code	Category	Prior Approval Required	Veteran Limit	Eligible Prescriber	Hire or Buy
AS14	Enteral Feeding Pump	No	1 per person	S/D/LMO	Buy
AS15	Enteral Feeding Pump Consumables	No	Functional need	LMO/RN/S/D	Buy
AS16	Bracelet - SOS Safety Alert	No	2 per person	LMO/S/RN	Buy
AS17	Replacement Parts and/or Repairs for AS items	No	Functional need	LMO/RN/OT/S	Buy
AT12	Drip Stand	No	1 every 5 yrs	LMO/S/RN/OT	HIRE
AU01	Bottom Wiper	No	2 every 2 yrs	OT/LMO/RN/S/Phys	Buy
AU02	Button Hook	No	1 every 2 yrs	OT/LMO/RN/S/Phys	Buy
AU03	Denture Brush with Suction Cup	No	2 per yr	OT/LMO/RN/S/LDO/Phys	Buy
AU04	Dressing Stick	No	1 every 2 yrs	OT/LMO/RN/S/Phys	Buy
AU08	Long Handled Comb/Brush	No	2 every 2 yrs	OT/LMO/RN/S/Phys	Buy
AU10	Long Handled Toe Wiper	No	2 per yr	OT/Pod/LMO/RN/S/Phys	Buy
AU13	Donning/doffing aids (i.e. for socks, stockings)	No	2 every 2 yrs	OT/Pod/LMO/RN/S/Phys	Buy
AU14	Shoe lace - elasticised (elastic shoe laces)	No	4 pairs per yr	OT/Pod/LMO/RN/S/Phys	Buy
AV01	Bicycle - Stationary Exercise	Yes	1 per person	Phys/S/Ch/Ost/LMO	HIRE
AV02	Pedals - Exercise	Yes	1 per person	Phys/S/Ch/Ost/LMO	Buy
AV10	Exercise Appliances - Progressive Elastic Resistance/Hand Cone/Exercise Putty	No	5 per yr	Phys/S/OT/Ch/Ost/LMO	Buy
AV16	Replacement Parts and/or Repairs for AV items	No	Functional need	Phys/S/Ch/Ost/LMO	Buy
AZ01	Bath Seat/Board	No	1 every 5 yrs	OT/RN/S/LMO	Buy
AZ02	Shower - Hand Held	No	1 per shower outlet	OT/RN/S/LMO	Buy
AZ03	Shower Seat - Fold Down	No	1 per shower outlet	OT/RN/S/LMO	Buy
AZ04	Shower Stool / Chair	No	1 every 2 yrs	OT/RN/S/Phys/LMO	Buy
AZ05	Replacement Parts And Repairs for AZ items	Yes	Functional need	OT, RN, S	Buy
AZ06	Waterproof Protectors for limbs	No	2 per limb per year	OT, RN, S/LMO	Buy
BD03	TENS Machine	No	1 every 2 yrs	Phys/PC/Ch/Ost/S/LMO	Buy
BD04	TENS Machine Accessories	No	1 every 2 yrs	Phys/PC/Ch/Ost/RN/S/LMO	Buy
BE01	Bidet (includes electronic model)	Yes	1 per person	OT/RN/CA/S/LMO	Buy
BE02	Commode Chair - (Bedside) - Toileting Appliances	No	1 every 5 yrs	OT/RN/CA/LMO	Buy
BE03	Commode Pan/Bed Pan/Slipper Pan	No	1 every 5 yrs	OT/RN/CA/S/LMO	Buy
BE04	Commode Shower Chair - mobile	No	1 every 5 yrs	OT/RN/CA/S/Phys/LMO	Buy
BE06	Over Toilet Frame / Toilet Surround	No	2 per person	OT/RN/CA/S/Phys/LMO	Buy
BE07	Porta Potty (includes frame and solution for continued use)	Yes	1 per person	OT/S/CA/RN/LMO	Buy
BE10	Toilet Seat - Raised	No	1 toilet only	OT/RN/Phys/S/LMO	Buy
BE11	Replacement Parts and/or Repairs for BE items	Yes	Functional need	OT/RN/Phys/CA/S/LMO	Buy

Key	
Ch	Chiropractor
S	Specialist (includes all medical specialists in relevant field)
D	Dietitian
LMO	Local Medical Officer (RR - remote areas)
LDO	Local Dental Officer
O	Orthotist
Ost	Osteopath
OT	Occupational Therapist
Physio	Physiotherapist
Pod	Podiatrist
P	Prosthetist
RN	Registered Nurse

DVA: Home Modifications

Safety in and Around the Home



Aidacare can arrange expert installation of everything you need to ensure the home is safe, secure and mobility friendly. Our experienced installers (Hire-a-Hubby and local contractors) are the best in the business and work with both the healthcare professional and private clients to achieve outstanding results

We can deliver:

- Order receipt confirmation by text/email
- Appointment booking call to therapist & Veteran/Client
- Job completion confirmation with therapist



Custom Ramps
(AL11)



Threshold Ramps
(AL11)
Refer pg 211



Non Slip Strips
(AL06)



Ceiling Hoists
(AN01)
Refer pg 147



Lever Taps
(AL00)



Toilet and Shower Rail
(AL09)
Refer pg 60



Shower Seat
(AZ03)
Refer pg 49



Hand Held Showers
(AZ02)
Refer pg 55



Falls Prevention and Safety in the Home is our
Number One Priority.

Call today for a free quote.

Fast, Efficient and Reliable Service.



Refer to page 11



AIDACARE's PREFERRED INSTALLER FOR ALL MINOR HOME MODIFICATIONS



You can feel confident in the quality of work we will provide with our 100% Workmanship Guarantee.

Hire a Hubby always strives to complete all repairs and services to the highest standards but if there is a reason you still aren't completely satisfied, we'll put it right.

Our fully trained and police checked hubbies are handymen you can trust. They consistently provide timely and professional service, helping to make your job easier by keeping your clients happy.

So let Hire a Hubby help you with all your property maintenance and repair needs.

THE HAH DIFFERENCE:

- Workmanship Guarantee • Police Checked • Fully Trained
- Public Liability Insurance • Value for Money

" MY MATES AT HIRE A HUBBY GIVE YOU A 100% WORKMANSHIP GUARANTEE, ALLOWING YOU TO REST EASY "

SCOTT CAM

**CALL US TODAY ON
1 300 888 052**

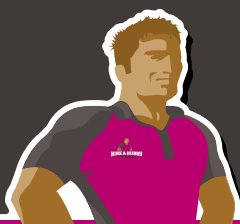

www.hireahubby.com.au

Aidacare Online

For all of your product enquiries in one user-friendly site visit us online at www.aidacare.com.au

- New product releases - updated daily
- Clear and concise product descriptions and specifications
- Contract specific ordering information (DVA, TAC & MASS)
- Downloadable DVA RAP and other order forms
- Full colour product images
- Information on our range of service offerings
- Newsletter subscription page

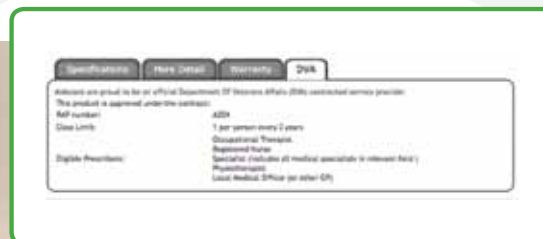

"We care for your care"



C.A.S.E (Customised and Specialised Equipment)

'Bringing Simplicity to Complexity'



Customised seating and mobility solutions for the individual.

The Aidacare Customised And Specialised Equipment (C.A.S.E) department is dedicated to providing specialised advice, service and equipment based solutions for our clients.

This highly specialised field is supported by our expert team of consultants with decades of practical hands on experience and professional training including qualified Physiotherapists, Occupational Therapists and Rehab Engineers.

The key focus areas of our C.A.S.E team includes:

- Scripted Manual Wheelchairs
- Scripted Power Wheelchairs
- Seating & Positioning Products
- Pressure Management Cushions
- Children's (Paediatric) rehabilitation equipment.
- Bariatric sized and expanded weight capacity equipment.

The Aidacare C.A.S.E philosophy is to assess and recommend the clinically appropriate product solution based on the individual client needs. We are not limited to a specific range or style, enabling our team to recommend the right option. Aidacare have access to the full scope of leading industry brands and models, sourced from the international industry leading manufacturers.

View our range of C.A.S.E **Wheelchairs & Seating** solutions refer to page 320

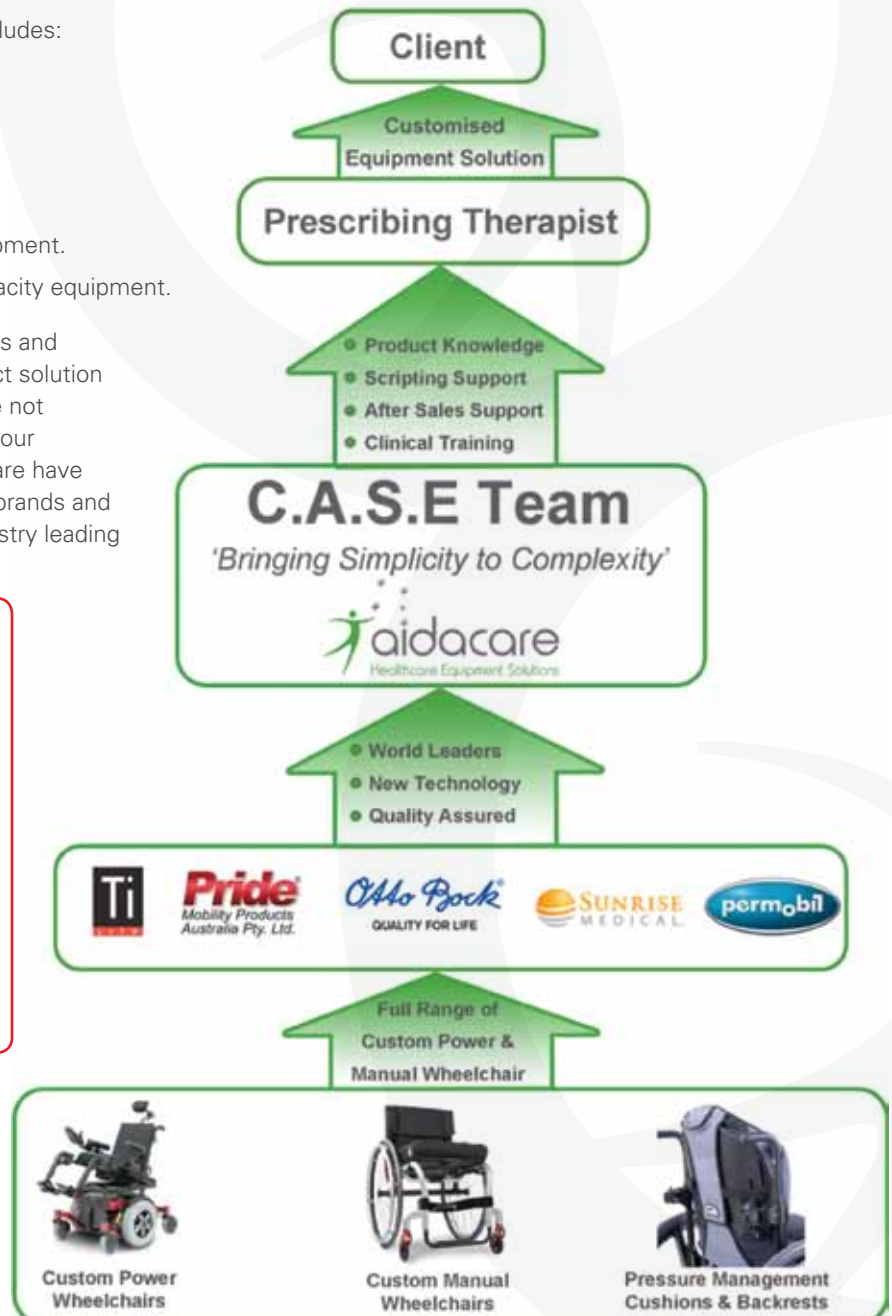

Equipment Rental



Who can you turn to when a family member, a client or you are in need of healthcare equipment for hire?

Aidacare are the industry experts you can trust to provide the healthcare equipment you need, when you need it. An expansive range of product styles to choose from for short, medium or long term needs.

- Wide range of products
- Quality assured products with the highest grade cleaning and sanitation
- Order over the phone, web, and fax or over the counter in one of our showrooms for immediate delivery
- We can deliver anywhere
- Complete set up in the home available
- Reliable, trustworthy service by experience staff



Lift Chairs



Hoists



Scoters



Walking Aids



Wheelchairs



Shower Commodes



Toilet Aids



Pressure Mattress & Cushions



Equipment Rental

Domestic or Commercial Environments



Home & Community Care

Everything you could need to set up a full care environment in the home. From a simple pair of crutches to a complete hospital in the home set up.

Hospital Ward & Discharge

Commercial grade equipment for the professional healthcare environment and an industry leading patient discharge program to ensure a safe and efficient patient discharge.



Specialist Equipment Rental

Aidacare understand the diverse needs of our clients and provide an expansive range of products to suit all shapes, sizes and medical conditions. From our paediatric ranges for kids to the extra large sized ranges for the Bariatric client of up to 300+ kg. Range includes beds, Lifting Hoists, Chairs, Walking Frames, Wheelchairs and mattresses.



Repairs & Maintenance



Expert Equipment Repair

At Aidacare we appreciate your healthcare equipment is vital in maintaining lifestyle and function for you, so when it's in need of repair, you need a repair service you can trust to fix it, and fix it fast.

Aidacare employ highly experienced, qualified technicians to keep your equipment running at its very best.

- Full Workshop Service
- Mobile technicians - we come to you!
- Authorised Warranty Repair Agent for all leading brands
- No job too large or small - from a tyre puncture to a complex electrical fault, Aidacare can fix it



Mobile Service Available

Workshop, Mobile, Preventative Repair and Maintenance.

Facility Services

New Fit-outs



Greenfield or Re-development?

Building a new Aged care facility from the ground up or extending or redeveloping an existing site?

Aidacare are the equipment supply experts to work with you or your developer to get the look and function you want out of your equipment



- Equipment type and quantity advice
- Workflow analysis to ensure mobile equipment (trolleys etc) meet both function and efficiency needs
- Project rates to keep you on budget
- Complete bedroom fit out package rates
- Combine purchasing of all equipment to a single supplier to achieve maximum value
- Free on-site assessment and comprehensive quotations
- Committed delivery dates and on-site set up and installation
- Project manager to oversee your new project from plan, quotation, order and delivery stages
- Call 1300 133 120 to arrange a complimentary consultation with one of our Aged Care Facility experts



Project Delivered - On Time, On Budget, Everytime.

Facility Services

Preventative Maintenance



Aidacare can provide a Preventative Maintenance Program for your Aged Care Facility, Hospital or Home & Community Care clients. This service ensures all healthcare equipment in use by you, your staff or your clients is serviced and maintained on a regular basis to industry safety and OH&S standards and regulations.

From a single item to a 150 bed facility, Aidacare can provide the solution to your equipment maintenance needs.

- Asset Audit & Tracking
- Full Service report and documentation provided per asset
- 6 monthly, 12 monthly or other frequency
- Electrical Test & Tag included
- Certificate of Completion issued
- Protect your assets & maintain warranty
- Protect your staff and clients
- Manage your re-issue pool



Workshop, Mobile, Preventative Repair and Maintenance.

Retail Showrooms



Visit one of our spacious showrooms to browse, test and try any of the 1000's of products available.



Occupational & Physio Therapist client visits are most welcome. No appointment necessary. Meet your clients on site to make use of our products and facilities.

Great handy ideas to help around the home. See the very latest in product design and innovations.



Call 1300 133 120 to confirm your local showroom trading hours. You never know what you will find!

We come to you!

Aidacare offer a complimentary in home equipment trial service. Priority service for all allied healthcare professionals.

- You book in the date, time and location - we'll be there.
- Test, trial and assess in the home environment. Make sure it's right.

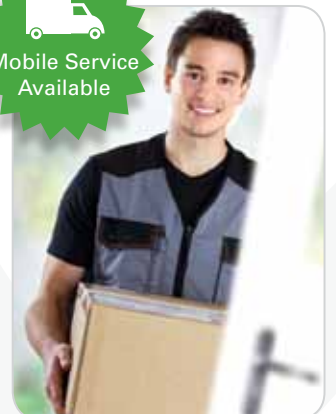

Home & Community Care

Service Solutions for EACH Package Providers



Our range of services:

- Group-wide Pricing Structures
- Establishment of H&CC Service Provider catalogue
- Free Equipment Trials
- Product Education Seminars for Staff/Carers
- Structured Ordering System
- Equipment Hire & Re-issue
- Asset Management
- Preventative Maintenance/Repairs
- Corporate Reporting System



Combine your group purchasing and service requirements to maximise efficiency, provide equality of services in all regions and enhance control of spend. We help you better manage your service to improve outcomes for all stakeholders.

Aidacare can introduce to your organisation a proven system of supply, service and reporting, designed to free up your staff to focus on client care.

Contact your local Aidacare office to arrange a complimentary assessment of requirements and establishment of service program.



We listen to your needs and build a customised service solution.

Aidacare Online

For all of your product enquiries in one user-friendly site visit us online at www.aidacare.com.au

- New product releases - updated daily
- Clear and concise product descriptions and specifications
- Contract specific ordering information (DVA, TAC & MASS)
- Downloadable DVA RAP and other order forms
- Full colour product images
- Information on our range of service offerings
- Newsletter subscription page

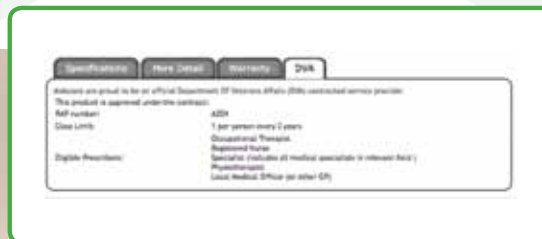

"We care for your care"



Bariatric



- P 23 What is Bariatric Equipment
- P 23 Bathroom & Toilet
- P 24 Bedroom
- P 25 Chairs -Therapeutic
- P 25 Manual Handling - Lifters & Slings
- P 25 Mobility Scooters
- P 26 Ramps
- P 26 Walking Frames & Aids - Mobility
- P 26 Ward & Clinic
- P 26 Wheelchairs & Seating - Mobility



What is Bariatric Equipment?



Bariatric equipment is identified throughout the catalogue by the use of this symbol.

Bariatric equipment is becoming ever more prevalent in the healthcare market but what is bariatrics and what is bariatric equipment?

Bariatrics deals with causation, the prevention and also the treatment of obesity in our community. With the current rise of obesity in our population, equipment needs have changed and there has been a demand to provide equipment in different configurations to meet these needs. Aidacare in conjunction with VicBIG* state that a Bariatric client may have one or more of the following characteristics:

- Weight Capacity > 125 kg
- Body Mass Index (BMI**) > 35
- Seat Width > 20" (50cm)

If one or more of these characteristics are present or anything else that is relevant, then an assessment of the client is required by their health professional. There are many variations to these characteristics but recognising the need to provide suitable equipment for Bariatric clients is paramount to the safety of the client as well the family, carers and health professionals.

Bariatric equipment is designed to assist in:

- Pressure management for the client
- Heat management for the client
- Effective weight distribution on the seating surface

Aidacare's Bariatric equipment range has been developed with our suppliers to ensure our range includes larger seat widths, increased weight capacities and reinforced construction materials to meet the specific needs of the user.

* VIC BIG (Victorian Bariatric Interest Group) Their aim is to raise the awareness of the complexity of safe and dignified management of the bariatric patient. www.vicbig.com

** BMI is defined as the weight in kilograms divided by the square of the height in metres (kg/m squared). BMI = weight (kg)/height (m) x height (m)

The classification of overweight and obesity, according to BMI, is shown in the table below. This applies to men and women over the age of 18.

Classification	Underweight	Normal Range	Overweight	Obese
BMI	Below 18.5	18.5 - 24.9	25.0 - 29.9	30 >

The following is an overview of the Bariatric equipment to be found in this catalogue together with the relevant reference page for full product details.

Bathroom & Toilet



150 kg

Shower Commode Att Prop
Platform Footrest
BTC061600
(refer to pg 29)



150 kg

Shower Commode Att Prop
BTC062000
(refer to pg 30)



150 kg

Shower Commode Self Prop
Swing Away Footrest
BTC063400
(refer to pg 30)



190 kg

Shower Commode Maxi
Att Prop
BTC062100
(refer to pg 32)

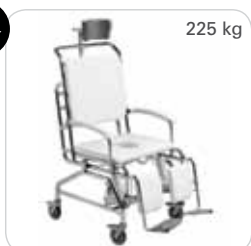

225 kg

Shower Commode Maxi
Tilt Att Prop
BTC064300
(refer to pg 32)

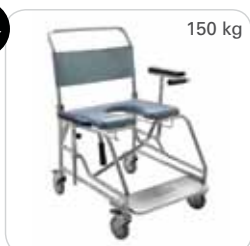

150 kg

Shower Commode Otto Bock
Att Prop
BTC061400
(refer to pg 39)

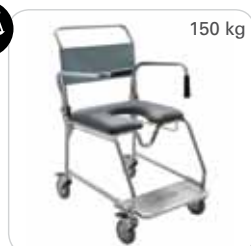

150 kg

Shower Commode Otto Bock
Att Prop
BTC066050
(refer to pg 39)



135 kg

Shower Chair Extra Wide
BTS105600
(refer to pg 45)



Shower Chair Maxi
Full Range
(refer to pg 46)



Shower Stool Maxi
Compact
BTS105200
(refer to pg 48)



Shower Stool Maxi
Full Range
(refer to pg 48)



Over Toilet Aid Maxi
Full Range
(refer to pg 56)



Toilet Seat Raiser
BTT149800
(refer to pg 59)



Bath Transfer Bench
Bariatric
BTS105300
(refer to pg 50)



Bathmaster Sonaris
BTS112700
(refer to pg 52)



Mobile Shower Trolley
Xtra Wide
BTS117803
(refer to pg 54)

Bedroom



King Single Bed Range
(refer to pg Bed Range)



Lifecomfort Bariatric
BEM046700
(refer to pg 83)



ROHO® Mattress Section
PTM636320
(refer to pg 80)



Ultimate 200 Digital
PTM636540
(refer to pg 84)



Ultimate 225 Digital
PTM636545
(refer to pg 84)

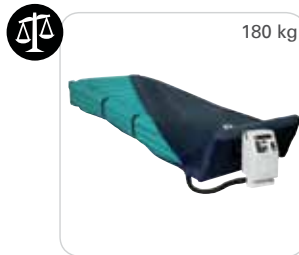

ROHO® SelectAir Max
PTM636620
(refer to pg 85)



Theraflow
PTM636640
(refer to pg 85)



SenTech Stage IV 2000
PTM636490
(refer to pg 85)



SenTech Stage IV Millen 3
PTM636506
(refer to pg 86)



SenTech Thera - Turn
Millen 48"
PTM636515
(refer to pg 86)



Bedside Commode Maxi
Fixed Height
Full Range
(refer to pg 89)



Bedside Commode Maxi
BEC046020
(refer to pg 89)



**Chairs -
Therapeutic**

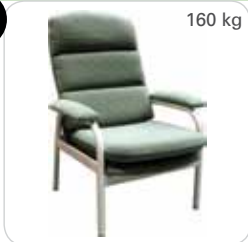

BC2
Full Range
(refer to pg 94)



**Hilite Chair Maxi and
Recliner**
Full Range
(refer to pg 93)



Utility Chair Maxi
Full Range
(refer to pg 95)



Maxi Hiback
CHP191150
(refer to pg 95)



Throne Chair
CHP191200
(refer to pg 96)



Comfort Chair
CHP192900
(refer to pg 96)



**Powerlift Recliner Ashley
Maxi**
Full Range
(refer to pg 100)



**Powerlift Recliner Ashley
Bariatric**
Full Range
(refer to pg 100)



Pride Powerlift Recliners
D30, C5, 560, 660, T3
(refer to pg 98-99)



Deluxe Bed Maxi
CHP198350
(refer to pg 103)

**Manual Handling
- Lifters & Slings**

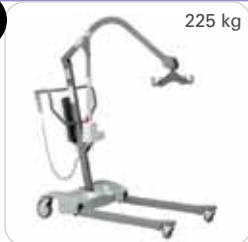

Ezy Lift Lifter
LSS379800
(refer to pg 139)

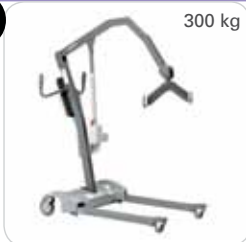

Maxi Lift Lifter
LSS362100
(refer to pg 139)

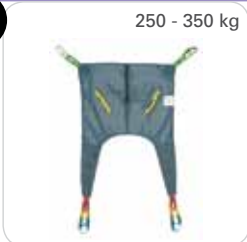

General Purpose Sling
Extra Large
Full Range
(refer to pg 141)

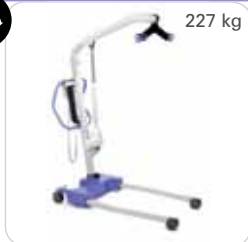

Oxford Lifters
Select Range
(refer to pg 144-145)

Mobility Scooters



Celebrity Deluxe XL
SCT670540
(refer to pg 156)



Pathrider 130 XL
Full Range
(refer to pg 158)



Pathrider 140 XL
Full Range
(refer to pg 158)



Ramps



272 kg

Silver Star Ramp
Full Range
(refer to pg 211)



300 kg

Senior Ramp
Full Range
(refer to pg 211)



300 kg

EBL Ramp
Full Range
(refer to pg 212)

Walking Frames & Aids - Mobility

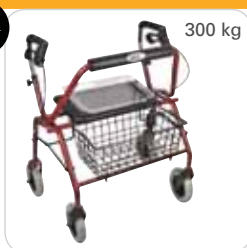

300 kg

Maxicare Walker
WAF699400
(refer to pg 296)



180 kg

Walking Tutors HD
Full Range
(refer to pg 298)

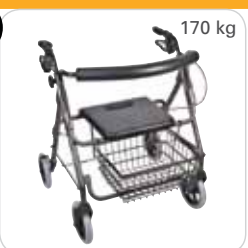

170 kg

Heavy Duty Envoy
WAF705900
(refer to pg 296)

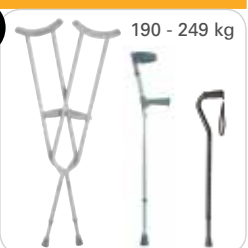

190 - 249 kg

Bariatric Crutches & Walking Stick
Full Range
(refer to pg 302 & 299)

Ward & Clinic



150 kg

Weigh Chair Digital
LSS377700
(refer to pg 319)



500 kg

Weigh Chair Digital Bariatric
LSS3362500
(refer to pg 319)



200 kg

Personal Scale Digital
LSS377690
(refer to pg 319)



300 kg

Wheelchair Scale Bariatric
LSS362000
(refer to pg 319)

Wheelchairs & Seating - Mobility

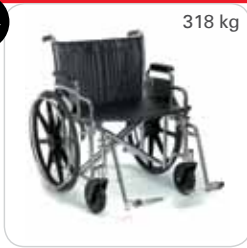

318 kg

Wheelchair Super HD
Full Range
(refer to pg 322)

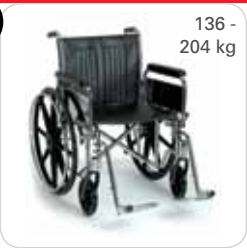

136 - 204 kg

Heavy Duty Wheelchair
Full Range
(refer to pg 322)



295 kg

Jazzy Power Range
Full Range
(refer to pg 335)

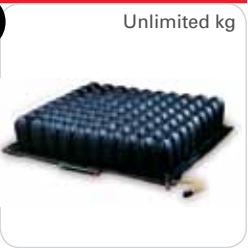

Unlimited kg

ROHO® Cushion
Select Range
(refer to pg 358- 360)



295 kg

J2 Plus Bariatric
Full Range
(refer to pg 354)

Aidacare Online

For all of your product enquiries in one user-friendly site visit us online at www.aidacare.com.au

- New product releases - updated daily
- Clear and concise product descriptions and specifications
- Contract specific ordering information (DVA, TAC & MASS)
- Downloadable DVA RAP and other order forms
- Full colour product images
- Information on our range of service offerings
- Newsletter subscription page

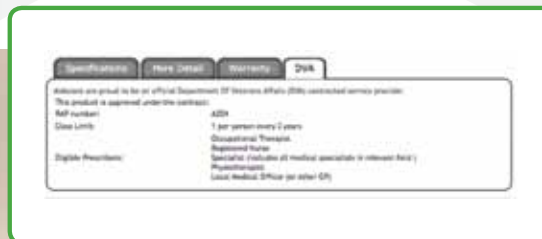

"We care for your care"



Bathroom & Toilet



- P 029 K Care Shower Commodes & Accessories
- P 039 Otto Bock Shower Commodes & Accessories
- P 044 Bed Pans & Urinals
- P 045 Shower Seating
- P 050 Transfer Aids
- P 053 Other - Shower
- P 056 Over Toilet Aids
- P 058 Other - Toilet
- P 060 Grab Rails



Option: Sliding F/board



Option: Pan Carrier

Shower Commode Budget

- Assists transportation of the user for showering and can be positioned over the toilet for toileting
- Swing out arms
- Plastic flip up toilet seat
- Mounted on 4 castors (2 of which are locking for stability)
- Mild steel tubing frame
- Optional sliding footrest available
- Warranty: 12 months

DVA CONTRACTED
BE04 BUY
Prescribers... OT/RN/CA/S/Phys/LMO
For approval rules refer to pg 7.



Code	Description	Frame Width	Seat Width	Seat Depth	Seat Height	Product Weight	Max. User Weight	Supplier Code	RAP #:
BTC070400	Shower Commode Budget	510 mm	440 mm	430 mm	520 mm	10 kg	120 kg	KA111Z	BE04
BTC081100	Sliding Footboard							KA23F	BE04



Option: Padded Seat



Option: Oxygen Bottle Holder

Shower Commode with Platform Footrest

- Assists transportation of the user for showering and can be positioned over the toilet for toileting
- Sliding platform footrest and swing out arms assists user comfort and transfers
- Padded or plastic flip up toilet seat available
- Mounted on 4 castors (2 are locking for stability)

DVA CONTRACTED
BE04 BUY
Prescribers... OT/RN/CA/S/Phys/LMO
For approval rules refer to pg 7.

- Stainless steel or zinc treated frame for corrosion resistance
- Warranty: 12 months

Note: Pictured with an optional closed padded commode seat (BTC075500)

Code	Description	Frame Width	Seat Width	Seat Depth	Seat Height	Product Weight	Max. User Weight	Supplier Code	RAP #:
BTC070600	Shower Commode Stainless Steel	510 mm	440 mm	430 mm	590 mm	11 kg	120 kg	KA112S	BE04
BTC070800	Shower Commode (zinc treated)	510 mm	440 mm	430 mm	590 mm	11 kg	120 kg	KA112Z	-
BTC070850	Shower Commode (zinc treated) DVA Kit w/ Seat & Pan (Same dimensions as above)								BE04
BTC061600	Shower Commode Platform Footrest	565 mm	500 mm	430 mm	590 mm	11 kg	150 kg	KA112S50	BE04



Option: Padded Seat



Option: Lock Down Arms

Shower Commode with Weight Bearing Platform

- Assists transportation of the user for showering and can be positioned over the toilet for toileting
- Weight bearing platform footrest and swing out arms assists safe patient transfers in and out of commode
- Ideal for multi user situations such as nursing facilities and hospitals
- Padded or plastic flip up toilet seat available
- Mounted on 4 castors (2 are locking for stability)

DVA CONTRACTED
BE04 BUY
Prescribers... OT/RN/CA/S/Phys/LMO
For approval rules refer to pg 7.

- Stainless steel frame for corrosion resistance
- Attendant propelled or self propelling (SP) versions
- Warranty: 12 months

Note: Pictured with an optional closed padded commode seat (BTC075500)

Code	Description	Frame Width	Seat Width	Seat Depth	Seat Height	Product Weight	Max. User Weight	Supplier Code	RAP #:
BTC070650	Shower Commode with Weight Bearing Platform	510 mm	440 mm	430 mm	590 mm	12 kg	150 kg	KA113S	BE04
BTC077950	Shower Commode with Weight Bearing Platform (S.P.)	510 mm	440 mm	430 mm	590 mm	17 kg	120 kg	KA123S	BE04



Option: Padded Seat



Option: Safety Arms

Shower Commode Swing Away Footrest

- Assists transportation of the user for showering and can be positioned over the toilet for toileting
- Stainless steel frame for corrosion resistance
- Fully height adjustable legrests to suit user needs
- Padded or plastic flip up toilet seat available
- Mounted on 4 castors (2 are locking for stability)

DVA CONTRACTED
BE04.....BUY
Prescribers...OT/RN/CA/S/Phys/LMO
For approval rules refer to pg 7.

- Swing away legrests and arms can be moved out of the way to assist transfers
- Warranty: 12 months

Note: Pictured with an optional closed padded commode seat (BTC075500)

Code	Description	Frame Width	Seat Width	Seat Depth	Seat Height	Product Wt.	Max. User Wt.	Supplier Code	RAP #:
BTC071000	S/ Commode Swing Away Footrest 400	460 mm	400 mm	430 mm	590 mm	12 kg	120 kg	KA114SJ	BE04
BTC070900	S/ Commode Swing Away Footrest 440	510 mm	440 mm	430 mm	590 mm	12 kg	120 kg	KA114S	BE04
BTC062000	S/ Commode Swing Away Footrest 500	560 mm	500 mm	430 mm	590 mm	17 kg	150 kg	KA114S50	BE04



Option: Padded Seat



Optional: Anti Tip Bars

Shower Commode Self Propelling

- Assists transportation of the user for showering and can be positioned over the toilet for toileting
- Designed for independent propulsion of the large rear wheels by the user
- Swing away legrests and arms can be moved out of the way to assist transfers
- Padded or plastic flip up toilet seat available
- Stainless steel frame for corrosion resistance

DVA CONTRACTED
BE04.....BUY
Prescribers...OT/RN/CA/S/Phys/LMO
For approval rules refer to pg 7.

- Available with swing away legrests, weight bearing footplate version, in a smaller 40 cm width model or front wheel propelling model
- Warranty: 12 months

Note: Pictured with an optional open padded commode seat (BTC075700)

Code	Description	Frame Width	Seat Width	Seat Depth	Seat Height	Product Wt.	Max. User Wt.	Supplier Code	RAP #:
BTC077900	S/ Commode SP Swing Away Footrest 440	510 mm	440 mm	430 mm	590 mm	17 kg	120 kg	KA120SR	BE04
BTC063400	S/ Commode SP Swing Away Footrest 500	560 mm	500 mm	430 mm	590 mm	17 kg	150 kg	KA120SR50	BE04



Option: Padded Seat



Option: Hand Made Seat

Shower Commode Folding

- Assists transportation of the user for showering and can be positioned over the toilet for toileting
- Folds neatly away for storage or transportation where space is limited
- Swing away legrests and arms can be moved out of the way to assist transfers
- Padded or plastic flip up toilet seat available

DVA CONTRACTED
BE04.....BUY
Prescribers...OT/RN/CA/S/Phys/LMO
For approval rules refer to pg 7.

- Mounted on 4 castors (2 are locking for stability)
- Stainless steel frame for corrosion resistance
- Warranty: 12 months

Note: Pictured with an optional open padded commode seat (BTC075700)

Code	Description	Frame Width	Seat Width	Seat Depth	Seat Height	Product Weight	Max. User Weight	Supplier Code	RAP #:
BTC071400	S/ Commode Folding	510 mm	440 mm	430 mm	590 mm	13 kg	120 kg	KA116S	BE04
BTC080500	S/ Commode Folding Self Propelling	510 mm	440 mm	430 mm	590 mm	18 kg	120 kg	KA130S	BE04
BTC080600	S/ Commode Folding Self Propelling, Left Hand Opening Frame	510 mm	440 mm	430 mm	590 mm	18 kg	120 kg	KA130SOL	BE04
BTC080700	S/ Commode Folding Self Propelling, Right Hand Opening Frame	510 mm	440 mm	430 mm	590 mm	18 kg	120 kg	KA130SOR	BE04



Option: Hand Made Seat



Option: Pan Carrier

Shower Commode Child

- Assists transportation of the user for showering and can be positioned over the toilet for toileting
- Small size for children or smaller users
- Swing away legrests and arms can be moved out of the way to assist transfers
- Padded or plastic flip up toilet seat available
- Mounted on 4 castors (2 are locking for stability)
- Stainless steel frame for corrosion resistance
- Warranty: 12 months

Note: Pictured with an optional open hand made padded commode seat (BTC073900)

Code	Description	Frame Width	Seat Width	Seat Depth	Seat Height	Product Weight	Max. User Weight	Supplier Code
BTC084800	Shower Commode Child	320 mm	320 mm	320 mm	590 mm	12 kg	95 kg	KA114SC
BTC085200	Shower Commode Child Self Propelling	320 mm	320 mm	320 mm	590 mm	17 kg	95 kg	KA120SRC



Option: Hand Made Seat



Option: Oxygen Bottle Holder

Shower Commode Tilt

- Assists transportation and positioning of the user for showering and can be positioned over the toilet for toileting
- Gas tilt in space mechanism allows carer to adjust the vertical position from 0 to 30 (degrees) ensuring user comfortably retains correct seating position
- Large calf pads to support the legs
- Large backrest with headrest extension to support the upper body and head
- Mounted on 4 locking castors for stability
- Stainless steel frame for corrosion resistance
- Available in a standard model (pictured), a deluxe version which comes with padded armrests and side panels as well an extra wide (50 cm) version
- Warranty: 12 months

Note: Pictured with optional hand made padded closed seat (BTC075500)

DVA CONTRACTED
 BE04..... BUY
 Prescribers... OT/RN/CA/S/Phys/LMO
 For approval rules refer to pg 7.

Code	Description	Frame Width	Seat Width	Seat Depth	Seat Height	Product Weight	Max. User Weight	Supplier Code	RAP #:
BTC071100	Shower Commode TIS 440	510 mm	440 mm	430 mm	590 mm	23 kg	135 kg	KF11507	BE04
BTC071350	Shower Commode TIS 500	560 mm	500 mm	430 mm	590 mm	23 kg	135 kg	KA115S50	BE04



Shower Commode Reclining

- Assists transportation and positioning of the user for showering and can be positioned over the toilet for toileting
- Carer can adjust the vertical position from 0 to 180 (degrees) ideal for supine transfer from a bed
- Large backrest to support the upper body and head
- Mounted on 4 locking castors for stability
- Stainless steel frame for corrosion resistance
- Swing up padded armrests, side panels, calf supports and footrests for added comfort
- Warranty: 12 months

Note: Open or closed seat available as standard

DVA CONTRACTED
 BE04..... BUY
 Prescribers... OT/RN/CA/S/Phys/LMO
 For approval rules refer to pg 7.

Code	Description	Frame Width	Seat Width	Seat Depth	Seat Height	Product Weight	Max. User Weight	Supplier Code	RAP #:
BTC082200	Shower Commode Reclining	690 mm	500 mm	430 mm	590 mm	32 kg	120 kg	KA117	BE04
BTC072270	Shower Commode Arms - Padded Arms - Not Fitted - for KA117 Recline							KA117-SPA	BE04



Option: Hand Made Seat



Option: Safety Arms

Shower Commode Maxi

- Assists transportation of the larger user for showering and can be positioned over the toilet for toileting
- Robust frame provides a greater level of support for the user requiring seat width greater than 500 mm and weight capacity up to 225 kgs
- Mounted on 4 locking castors for stability
- Removable padded armrests and swing away leg rests, or sliding platform footrest for comfort

✓ DVA CONTRACTED
BE04 BUY
Prescribers... OT/RN/CA/S/Phys/LMO
For approval rules refer to pg 7.

- Reinforced stainless steel frame for corrosion resistance
 - Warranty: 12 months
- Note: Pictured with optional hand made padded open seat (BTC073900)

Code	Description	Frame Width	Seat Width	Seat Depth	Height	Product Weight	Max. User Weight	Supplier Code	✓ RAP #:
BTC062100	S/ Commode Swing Away Footrest 550	610 mm	550 mm	440 mm	590 mm	17 kg	190 kg	KA114S55	BE04
BTC062200	S/ Commode Swing Away Footrest 600	660 mm	600 mm	450 mm	590 mm	19 kg	210 kg	KA114S60	BE04
BTC062300	S/ Commode Swing Away Footrest 650	710 mm	650 mm	460 mm	590 mm	21 kg	225 kg	KA114S65	BE04



Option: Hand Made Seat



Option: Drop Side Arms

Shower Commode Maxi Platform Footrest

- Assists transportation of the larger user for showering and can be positioned over the toilet for toileting
- Robust frame provides a greater level of support for the user requiring seat width greater than 500 mm and
- Mounted on 4 locking castors for stability
- Reinforced stainless steel frame for corrosion resistance
- weight capacity up to 225 kgs

✓ DVA CONTRACTED
BE04 BUY
Prescribers... OT/RN/CA/S/Phys/LMO
For approval rules refer to pg 7.

- Removable padded armrests and swing away leg rests, or sliding platform footrest for comfort
 - Warranty: 12 months
- Note: Pictured with optional closed hand made padded seat (BTC075500)

Code	Description	Frame Width	Seat Width	Seat Depth	Height	Product Weight	Max. User Weight	Supplier Code	✓ RAP #:
BTC061700	S/ Commode Platform Footrest 550	610 mm	550 mm	440 mm	590 mm	15 kg	190 kg	KA112S55	BE04
BTC061800	S/ Commode Platform Footrest 600	660 mm	600 mm	450 mm	590 mm	17 kg	210 kg	KA112S60	BE04
BTC061900	S/ Commode Platform Footrest 650	710 mm	650 mm	460 mm	590 mm	19 kg	225 kg	KA112S65	BE04



Option: Hand Made Seat



Option: Stump Support

Shower Commode Maxi Tilt

- Assists transportation and positioning of the larger user for showering and can be positioned over the toilet for toileting
- Gas tilt in space mechanism allows carer to adjust the vertical position from 0 to 30 (degrees) ensuring user comfortably retains correct seating position
- Large calf pads to support the legs
- Mounted on 4 locking castors for stability
- Stainless steel frame for corrosion resistance

✓ DVA CONTRACTED
BE04 BUY
Prescribers... OT/RN/CA/S/Phys/LMO
For approval rules refer to pg 7.

- Large backrest with headrest extension to support the upper body and head
 - Suits pan carrier frame BTC077000 and bowl carrier frame BTC076500
 - Warranty: 12 months
- Note: Pictured with an optional closed hand made padded seat (BTC075500)

Code	Description	Width	Seat Width	Seat Depth	Seat Height	Product Weight	Max. User Weight	Supplier Code	✓ RAP #:
BTC064300	S/ Commode Swing Away Footrest	710 mm	600 mm	470 mm	590 mm	32 kg	225 kg	KF11506	BE04
BTC071200	S/ TIS Deluxe (includes Padded Armrests and Side Panels)	510 mm	440 mm	430 mm	590 mm	23 kg	135 kg	KA115SRA	BE04

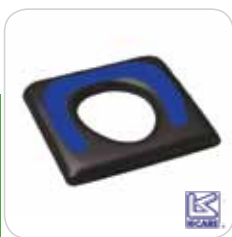

Pressure Reducing Seat

- Special foam design, engineered to improve the spread of pressure across the seat complements the users pressure management routine
- Waterproof but breathable antimicrobial four-way stretch Dartex material to optimises user comfort
- Independently tested and proven to be effective in reducing pressure levels
- Seat height: 65 mm
- Warranty: 12 months

REFER PG 42 FOR ROHO
COMMUNE PRESSURE
REDUCING SHOWER
COMMUNE SEAT (BTC067300)

DVA For eligibility & prescriber info please refer to pg 7.

Code	Description	Seat Width	Seat Depth	Supplier Code	RAP #:	Code	Description	Seat Width	Seat Depth	Supplier Code	RAP #:
BTC082100	Pressure Reducing Closed Seat 44	440 mm	430 mm	KF01132	BE04	BTC082000	Pressure Reducing Open Seat 44	440 mm	430 mm	KF01131	BE04
BTC063500	Pressure Reducing Closed Seat 50	500 mm	430 mm	KF01133	BE04	BTC063900	Pressure Reducing Open Seat 50	500 mm	430 mm	KF01137	BE04
BTC063600	Pressure Reducing Closed Seat 55	550 mm	430 mm	KF01134	BE04	BTC064000	Pressure Reducing Open Seat 55	550 mm	430 mm	KF01138	BE04
BTC063700	Pressure Reducing Closed Seat 60	600 mm	430 mm	KF01135	BE04	BTC064100	Pressure Reducing Open Seat 60	600 mm	430 mm	KF01139	BE04
BTC063800	Pressure Reducing Closed Seat 65	650 mm	430 mm	KF01136	BE04	BTC064200	Pressure Reducing Open Seat 65	650 mm	430 mm	KF01140	BE04



Padded Open Seat

- High quality machine made padded seat with an open front for personal cleaning and toileting access
- Available in a blue (pictured) or white
- Supplied with plastic seat runners for easy attachment and removal during cleaning of the seat and commode
- Warranty: 12 months



Padded Closed Seat

- High quality machine made padded seat with a closed front for personal cleaning and toileting access
- Available in a blue (pictured) or white
- Supplied with plastic seat runners for easy attachment and removal during cleaning of the seat and commode
- Warranty: 12 months

DVA For eligibility & prescriber info please refer to pg 7.

Code	Description	Seat Width	Seat Depth	Seat Height	Supplier Code	RAP #:
BTC075700	P/ Open Seat, B	440 mm	430 mm	40 mm	KA11POPB	BE04
BTC075800	P/ Open Seat, W	440 mm	430 mm	40 mm	KA11POPWH	BE04

DVA For eligibility & prescriber info please refer to pg 7.

Code	Description	Seat Width	Seat Depth	Seat Height	Supplier Code	RAP #:
BTC075500	P/ Closed Seat, B	440 mm	430 mm	40 mm	KA11PCPB	BE04
BTC075600	P/ Closed Seat, W	440 mm	430 mm	40 mm	KA11PCPWH	BE04



Hand Made Seat - Open

- Superior quality white marine grade vinyl provides durability and comfort
- Vinyl is wrapped, stapled and sealed, making cleaning easier with no seam on the inside of the aperture
- Comes with plastic seat runners for easy attachment and removal for cleaning
- Seat height is 55 mm
- Warranty: 12 months

DVA For eligibility & prescriber info please refer to pg 7.

Code	Description	Seat Width	Seat Depth	Supplier Code	RAP #:
BTC085000	Hand Made Open Seat 32	320 mm	430 mm	KA11HCOP	-
BTC073900	Hand Made Open Seat 40	400 mm	430 mm	KA11HJOP	BE04
BTC074400	Hand Made Open Seat 44	440 mm	430 mm	KA11HOP	BE04
BTC062800	Hand Made Open Seat 50	400 mm	430 mm	KA11O50	BE04
BTC062900	Hand Made Open Seat 55	550 mm	430 mm	KA11O55	BE04
BTC063000	Hand Made Open Seat 60	600 mm	430 mm	KA11O60	BE04
BTC063100	Hand Made Open Seat 65	650 mm	430 mm	KA11O65	BE04



Hand Made Seat - Closed

- Superior quality white marine grade vinyl provides durability and comfort
- Vinyl is wrapped, stapled and sealed, making cleaning easier with no seam on the inside of the aperture
- Comes with plastic seat runners for easy attachment and removal for cleaning
- Seat height is 55 mm
- Warranty: 12 months

DVA For eligibility & prescriber info please refer to pg 7.

Code	Description	Seat Width	Seat Depth	Supplier Code	RAP #:
BTC084900	Hand Made Closed Seat 32	320 mm	430 mm	KA11HCOP	-
BTC073800	Hand Made Closed Seat 40	400 mm	430 mm	KA11HJCP	BE04
BTC073700	Hand Made Closed Seat 40	400 mm	430 mm	KA11HCP	BE04
BTC062400	Hand Made Closed Seat 50	500 mm	430 mm	KA11C50	BE04
BTC062500	Hand Made Closed Seat 55	550 mm	430 mm	KA11C55	BE04
BTC062600	Hand Made Closed Seat 60	600 mm	430 mm	KA11C60	BE04
BTC062700	Hand Made Closed Seat 65	650 mm	430 mm	KA11C65	BE04



Plastic Seat

- High quality machine made seat with an open front for personal cleaning and toileting access
- Available in a white (pictured) or blue
- Supplied with plastic seat runners for easy attachment and removal during cleaning of the seat and commode
- Warranty: 12 months

DVA For eligibility & prescriber info please refer to pg 7.

Code	Description	Seat Width	Seat Depth	Supplier Code	RAP #:
BTC074900	Plastic O/ Seat	440 mm	430 mm	KA11O	BE04
BTC072500	Plastic C/ Seat	440 mm	430 mm	KA11C	BE04



Hand Made Wedge Seat

- Provides specific pelvic positioning
- Marine Grade vinyl is wrapped, stapled and sealed, making cleaning easier with no seam
- Open and closed configuration available
- Comes with plastic seat runners for easy attachment and removal for cleaning

DVA For eligibility & prescriber info please refer to pg 7.

Code	Description	Seat Width	Seat Depth	Supplier Code	RAP #:
BTC074100	H/made Wedge	440 mm	430 mm	KA11HMHP	BE04



Stump Support Left

- Comfortably supports the users stump or leg and therefore upper body
- Fully height adjustable and easy to fit
- Supportive waterproof pad
- Warranty: 12 months

DVA For eligibility & prescriber info please refer to pg 7.

Code	Description	Supplier Code	RAP #:
BTC079900	Stump Support Left	KA12LP	BE04



ROHO Pressure Reducing Commode Cushion

Code	Description
BTC067300	ROHO 18.5 x 18.5"
BTC067250	ROHO 18.5 x 16"
BTC067400	ROHO 18.5 x 20"
BTC067500	ROHO 15 x 16.75"
BTC067600	ROHO 16.75 x 18.5"
BTC067900	ROHO 16.75 x 16.75"



Padded Tie on Closed Seat

- High quality machine made seat with closed front
- Tie on and velcro attachments for secure fit
- Also available is a tie on padded seat as pictured (BTC076000)
- Warranty: 12 months

DVA For eligibility & prescriber info please refer to pg 7.

Code	Description	Seat Width	Seat Depth	Supplier Code	RAP #:
BTC075900	Padded Tie on Closed Seat	440 mm	430 mm	KA11PS	BE04



Pan Carrier

- Carries a pan below the commode seat
- Carrier slides easily into the shower commode seat (pictured with optional bed pan - BTT151800)
- Available in either a stainless steel or epoxy coated mode
- Warranty: 12 months

DVA For eligibility & prescriber info please refer to pg 7.

Code	Description	Supplier Code	RAP #:
BTC073100	Pan Carrier, Epoxy	KA11EPP	BE04
BTC077000	Pan Carrier Junior, Stainless Steel	KA11SPJP	BE04

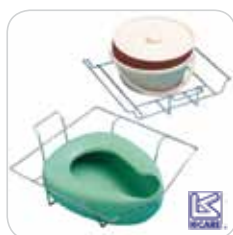

Bowl Carrier

- Carries a bowl below the commode seat
- Carrier slides easily into the shower commode seat (pictured with optional bowl - BTC081600)
- Stainless steel and fits a large range of bowls
- Available in either a stainless steel or epoxy coated mode
- Warranty: 12 months

DVA For eligibility & prescriber info please refer to pg 7.

Code	Description	Supplier Code	RAP #:
BTC076600	Bowl Carrier, Stainless Steel	KA11SBP	BE04
BTC076500	Bowl Carrier Junior, Stainless Steel	KA11SBJP	BE04



IV Pole

- Easy to fit telescoping I.V. Pole
- Attaches to the range of mobile shower commodes
- Warranty: 12 months

DVA For eligibility & prescriber info please refer to pg 7.

Code	Description	Supplier Code	RAP #:
BTC074600	IV Pole	KA11IV	BE04



Oxygen Bottle Carrier

- Easy to fit oxygen bottle holder that attaches to the range of mobile shower commodes
- Warranty: 12 months

DVA For eligibility & prescriber info please refer to pg 7.

Code	Description	Supplier Code	RAP #:
BTC075000	Oxygen Bottle Carrier	KA11OX	BE04



Lock Down Arms

- Easy to fit lock down armrests provide support on the armrest of the mobile shower commode range
- Warranty: 12 months

DVA For eligibility & prescriber info please refer to pg 7.

Code	Description	Supplier Code	RAP #:
BTC074700	Lock Down Arms	KA11L	BE04



Folding Safety Arms

- Supports the user on the commode
- Easy to fit folding safety arm provide security to the user and carer on mobile shower commodes
- Provides security to the user and carer
- Warranty: 12 months

DVA For eligibility & prescriber info please refer to pg 7.

Code	Description	Supplier Code	RAP #:
BTC071600	Folding Safety Arms	KA11AFS	BE04



Drop Side Arms

- Arms drop to the side of the shower commode
- Assist transfers where more access is required to the seat
- Modifications may be required as this is a custom made commode fitting
- Warranty: 12 months

DVA For eligibility & prescriber info please refer to pg 7.

Code	Description	Supplier Code	RAP #:
BTC072900	Drop Side Arms	KA11DAF	BE04

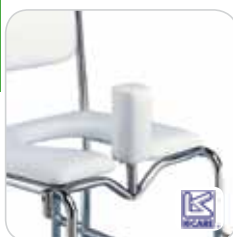

Pommel

- Assists leg positioning for the user whilst on the mobile shower commode
- Modifications may be required as this is a custom made commode fitting
- Warranty: 12 months

DVA For eligibility & prescriber info please refer to pg 7.

Code	Description	Supplier Code	RAP #:
BTC075100	Pommel	KA11P	BE04



Anti Tip Bars

- Prevent the chair or commode from easily tipping over backwards
- Safety measure for user and carer
- Easy to fit, attach to the rear of the mobile shower commode
- Warranty: 12 months

DVA For eligibility & prescriber info please refer to pg 7.

Code	Description	Supplier Code	RAP #:
BTC078300	Anti Tip Bars	KA12B	BE04



Fixed Curved Padded Back

- Provides a stable and comfortable padded back support for the user
- Modifications may be required as this is a custom made commode fitting
- Warranty: 12 months

DVA For eligibility & prescriber info please refer to pg 7.

Code	Description	Supplier Code	RAP #:
BTC075300	Fixed Curved Padded Back	KA11PBF	BE04
BTC075200	Padded Tie on Back	KA11PB	BE04



Brake Extension

- Extension brake levers for handy user access to braking mechanism
- Easy to fit to self propelling mobile shower commodes providing more independence for the user
- Promotes independence for the user
- Warranty: 12 months

DVA For eligibility & prescriber info please refer to pg 7.

Code	Description	Supplier Code	RAP #:
BTC078400	Brake Extension	KA12BE	BE04



Contoured Headrest

- Comfortably supports the users head and therefore upper body
- Easy to fit bolt on the mobile shower commode range
- Warranty: 12 months

DVA For eligibility & prescriber info please refer to pg 7.

Code	Description	Supplier Code	RAP #:
BTC079600	Contoured Headrest	KA12HR	BE04



Stump Support

- Stump Support is a swing away padded vinyl support
- Adjustable 500 mm from below to above seat.
- Warranty: 12 months

DVA For eligibility & prescriber info please refer to pg 7.

Code	Description	Supplier Code	RAP #:
BTC079900	Stump Support Left	KA12LP	BE04
BTC080200	Stump Support Right	KA12RP	BE04



Footplate Extended

- Provides a larger surface to the footplate for added security and improved foot positioning
- Modifications may be required as this is a custom made commode fitting
- Warranty: 12 months

DVA For eligibility & prescriber info please refer to pg 7.

Code	Description	Supplier Code	RAP #:
BTC078900	Footplate Extended	KA12FF	BE04



Leg Extension

- Supports the entire leg in a horizontal position
- Replaces the existing legrest
- Warranty: 12 months

DVA For eligibility & prescriber info please refer to pg 7.

Code	Description	Supplier Code	RAP #:
BTC079700	Leg Extension Single	KA12L	BE04
BTC079800	Leg Extension Double	KA12LD	BE04



Swing Away Legrests

- Provides leg support and swings away to assist transfers
- Replacement to suit swing away legrest models of the mobile shower commode range
- Warranty: 12 months

DVA For eligibility & prescriber info please refer to pg 7.

Code	Description	Supplier Code	RAP #:
BTC080300	Swing Away Legrests	KA12SSF	BE04
BTC080350	Swing Away Legrests for KA114S55		BE04



Elevating Legrest

- Provides elevating leg support and swings away to assist transfers
- Suits swing away legrest models of the mobile shower commode range
- Warranty: 12 months

DVA For eligibility & prescriber info please refer to pg 7.

Code	Description	Supplier Code	RAP #:
BTC078500	Elevating Legrest Left	KA12ELL	BE04
BTC078700	Elevating Legrest Right	KA12ELR	BE04



Pelvic Strap

- Assists support the seating position of the user whilst in the mobile shower commode
- Modifications may be required as this is a custom made commode fitting
- Warranty: 12 months

DVA For eligibility & prescriber info please refer to pg 7.

Code	Description	Supplier Code	RAP #:
BTC071800	Pelvic Strap - Fitted	KA11APS	BE04
BTC077300	Shower Commode Pelvic/Chest Strap - Fitted	KA11STF	BE04
BTC077200	Pelvic or Chest Strap	KA11ST	BE04



Padded Arms

- Will fit all model arms
- Must be fitted at time of manufacture
- Warranty: 12 months

DVA For eligibility & prescriber info please refer to pg 7.

Code	Description	Supplier Code	RAP #:
BTC072300	Padded Arms - Fitted	KA11AWF	BE04
BTC072200	Padded Arms	KA11AW	BE04
BTC072350	Padded Arms - Swing Up	KA11AS	BE04



Swing Up Arms

- Height to top of arms from top of seat is 190 mm
- Warranty: 12 months

DVA For eligibility & prescriber info please refer to pg 7.

Code	Description	Supplier Code	RAP #:
BTC072000	Swing Up Arms - Short	KA11ASS	BE04
BTC071900	Swing Up Arms S/Steel	KA11AWF/11AS	BE04



Gutter Supports

- Assist with correct positioning of the users arms
- Large curved troughs provide support to stop the arms sliding off the armrests
- Modifications may be required as this is a custom made commode fitting
- Warranty: 12 months

DVA For eligibility & prescriber info please refer to pg 7.

Code	Description	Supplier Code	RAP #:
BTC073600	Gutter Supports - Fitted	KA11GF	BE04
BTC073500	Gutter Supports	KA11G	BE04



K Care Shower Commodes Accessories Matrix			Accessories Fit Commode Code(s)																								
			BTC070400	BTC070600	BTC070800	BTC070650	BTC070900	BTC071000	BTC084800	BTC085200	BTC071400	BTC080500	BTC080600	BTC080700	BTC077900	BTC071100	BTC071200	BTC062200	BTC062000	BTC062100	BTC061600	BTC061700	BTC061800	BTC061900	BTC063400		
			BE04	BE04	-	BE04	BE04	BE04	-	-	BE04	BE04	BE04	BE04	BE04	BE04	BE04	BE04	BE04	BE04	BE04	BE04	BE04	BE04	BE04		
Code	Accessory Description	RAP #:																									
BTC075500	Padded Closed Seat Blue 440 mm	BE04	•	•	•	•					•	•			•	•	•										
BTC075600	Padded Closed Seat White 440 mm	BE04	•	•	•	•					•	•			•	•	•										
BTC075700	Padded Open Seat Blue 440 mm	BE04	•	•	•	•					•	•			•	•	•										
BTC075800	Padded Open Seat White 440 mm	BE04	•	•	•	•					•	•			•	•	•										
BTC075900	Padded Tie on Closed Seat	BE04	•	•	•	•					•	•			•	•	•										
BTC076000	Padded w/ velcro Closed Seat	BE04	•	•	•	•					•	•			•	•	•										
BTC072500	Plastic Closed Seat	BE04	•	•	•	•					•	•			•	•	•										
BTC074900	Plastic Open Seat	BE04	•	•	•	•					•	•			•	•	•										
BTC085000	Hand Made Open Seat 320 mm	-							•	•																	
BTC073900	Hand Made Open Seat 400 mm	BE04						•																			
BTC074400	Hand Made Open Seat 450 mm	BE04	•	•	•	•					•	•			•	•	•										
BTC062800	Hand Made Open Seat 500 mm	BE04																	•		•						
BTC062900	Hand Made Open Seat 550 mm	BE04																		•		•					
BTC063000	Hand Made Open Seat 600 mm	BE04																						•		•	
BTC063100	Hand Made Open Seat 650 mm	BE04																							•		
BTC084900	Hand Made Closed Seat 320 mm	-							•	•																	
BTC073800	Hand Made Closed Seat 400 mm	BE04						•																			
BTC073700	Hand Made Closed Seat 450 mm	BE04	•	•	•	•					•	•			•	•	•										
BTC062400	Hand Made Closed Seat 500 mm	BE04																		•		•					
BTC062500	Hand Made Closed Seat 550 mm	BE04																			•		•				
BTC062600	Hand Made Closed Seat 600 mm	BE04																						•		•	
BTC062700	Hand Made Closed Seat 650 mm	BE04																							•		
BTC074000	Hand Made Open Seat Left Open	BE04	•	•	•	•					•	•			•	•	•										
BTC074500	Hand Made Open Seat Right Open	BE04	•	•	•	•					•	•			•	•	•										
BTC074100	Hand Made Closed Seat Wedge	BE04	•	•	•	•	•	•	•	•	•	•	•	•	•	•	•										
BTC082000	Pressure Reducing Open Seat 450 mm	BE04	•	•	•	•					•	•			•	•	•										
BTC082100	Pressure Reducing Closed Seat 450 mm	BE04	•	•	•	•					•	•			•	•	•										
BTC063900	Pressure Reducing Open Seat 500 mm	BE04																		•		•					
BTC064000	Pressure Reducing Open Seat 550 mm	BE04																			•		•				
BTC064100	Pressure Reducing Open Seat 600 mm	BE04																						•		•	
BTC064200	Pressure Reducing Open Seat 650 mm	BE04																							•		
BTC063500	Pressure Reducing Closed Seat 500 mm	BE04																	•		•						
BTC063600	Pressure Reducing Closed Seat 550 mm	BE04																		•		•					



K Care Shower Commodes Accessories Matrix		Accessories Fit Commode Code(s)																							
Code	Accessory Description	RAP #:	BTC070400	BTC070600	BTC070800	BTC070650	BTC070900	BTC071000	BTC084800	BTC085200	BTC071400	BTC080500	BTC080600	BTC080700	BTC077900	BTC071100	BTC071200	BTC062200	BTC062000	BTC062100	BTC061600	BTC061700	BTC061800	BTC061900	BTC063400
			BE04	BE04	BE04	BE04	BE04	BE04	BE04	BE04	BE04	BE04	BE04	BE04	BE04	BE04	BE04	BE04	BE04	BE04	BE04	BE04	BE04	BE04	BE04
BTC063700	Pressure Reducing Closed Seat 600 mm	BE04																							
BTC063800	Pressure Reducing Closed Seat 650 mm	BE04																							
BTC077100	Pan Carrier S/S	BE04	•	•	•	•	•				•	•	•	•	•	•	•								
BTC077000	Pan Carrier S/S Junior	BE04						•	•	•															
BTC073100	Pan Carrier Epoxy	BE04	•	•	•	•	•				•	•	•	•	•	•	•								
BTC076600	Bowl Carrier S/S	BE04	•	•	•	•	•				•	•	•	•	•	•	•								
BTC076500	Bowl Carrier S/S Junior	BE04						•	•	•															
BTC073500	Gutter Support	BE04	•	•	•	•	•	•	•	•	•	•	•	•	•	•	•	•	•	•	•	•	•	•	•
BTC074600	IV Pole	BE04	•	•	•	•	•	•	•	•	•	•	•	•	•	•	•	•	•	•	•	•	•	•	•
BTC075000	Oxygen Bottle Carrier	BE04	•	•	•	•	•	•	•	•	•	•	•	•	•	•	•	•	•	•	•	•	•	•	•
BTC072200	Padded Arms	BE04	•	•	•	•	•	•	•	•	•	•	•	•	•	•	•	•	•	•	•	•	•	•	•
BTC074800	Lock Down Arms	BE04	•	•	•	•	•	•	•	•	•	•	•	•	•	•	•	•	•	•	•	•	•	•	•
BTC071600	Folding Safety Arms	BE04	•	•	•	•	•	•	•	•	•	•	•	•	•	•	•	•	•	•	•	•	•	•	•
BTC071900	Swing Up Arms	BE04	•	•	•	•	•	•	•	•	•	•	•	•	•	•	•	•	•	•	•	•	•	•	•
BTC072900	Drop Side Arms	BE04	•	•	•	•	•	•	•	•	•	•	•	•	•	•	•	•	•	•	•	•	•	•	•
BTC075200	Tie on Padded Back	BE04	•	•	•	•	•	•	•	•	•	•	•	•	•	•	•	•	•	•	•	•	•	•	•
BTC077200	Pelvic or Chest Strap	BE04	•	•	•	•	•	•	•	•	•	•	•	•	•	•	•	•	•	•	•	•	•	•	•
BTC075100	Pommel	BE04	•	•	•	•	•	•	•	•	•	•	•	•	•	•	•	•	•	•	•	•	•	•	•
BTC072600	Castors With Brakes	BE11	•	•	•	•	•	•	•	•	•	•	•	•	•	•	•	•	•	•	•	•	•	•	•
BTC081100	Footrest Sliding	BE04	•																						
BTC078300	Anti Tilt Bars	BE04							•		•	•	•	•											
BTC075300	Fixed Curved Padded Back	BE04	•	•	•	•	•	•	•	•	•	•	•	•	•	•	•	•							
BTC078400	Brake Extension	BE04							•		•	•	•	•											
BTC079600	Contoured Headrest	BE04	•	•	•	•	•	•	•	•	•	•	•	•	•	•	•	•	•	•	•	•	•	•	•
BTC080200	Stump Support Right	BE04		•	•	•	•	•	•	•	•	•	•	•	•	•	•	•	•	•	•	•	•	•	•
BTC079900	Stump Support Left	BE04		•	•	•	•	•	•	•	•	•	•	•	•	•	•	•	•	•	•	•	•	•	•
BTC078900	Footplate Extended	BE04					•	•	•	•	•	•	•	•	•	•	•	•							
BTC079700	Leg Extension Single	BE04	•	•	•	•	•	•	•	•	•	•	•	•	•	•	•	•	•	•	•	•	•	•	•
BTC079800	Leg Extension Double	BE04	•	•	•	•	•	•	•	•	•	•	•	•	•	•	•	•	•	•	•	•	•	•	•
BTC080300	Swing Away Legrests	BE04					•	•			•	•	•	•											
BTC078500	Elev Legrest Left	BE04					•	•			•	•	•	•											
BTC078700	Elev Legrest Right	BE04					•	•			•	•	•	•											



Option: Open Seat



Option: Safety Swing Arm

Weight Bearing Platform 460

This commode includes safety armrests and can be supplied in either a self propelling or attendant propelled version. Stainless steel casters provide excellent longevity and ease of use, particularly in a hospital or residential care environment. The frame width is 46 cm.

- Easy foot-operated sliding, non-slip, weight bearing platform
- Removable and adjustable seat with 70 mm travel
- Stainless steel casters

DVA CONTRACTED

BE04..... BUY

Prescribers... OT/RN/CA/S/Phys/LMO

For approval rules refer to pg 7.

- Selection of seamless PU seat, or a soft comfort seat
- Swing back independent armrests with safety arms
- Stainless steel pan rack guides
- Australian Standards approved to 150 kg

Note: Pictured with an optional open seat (BTC066600)

Code	Description	Overall Height	Overall Width	Seat Width	Backrest Height	Armrest Height	Lower Leg Length	Anterior Seat Height	Posterior Seat Height	RAP #:
BTC066000	WB Platform - 460 mm - Att Prop - S/Steel	994 mm	512 mm	460 mm	307 mm	228 mm	398 mm	587 mm	557 mm	BE04
BTC066200	WB Platform - 460 mm - Self Prop - S/Steel	994 mm	656 mm	460 mm	307 mm	230 mm	398 mm	587 mm	556 mm	BE04



Option: Open Seat



Option: Comfort Backrest

Weight Bearing Platform 530

This commode includes safety armrests and can be supplied in either a self propelling or attendant propelled version. The frame width is 53 cm.

- Easy foot-operated sliding, non-slip, weight bearing platform
- Removable and adjustable seat with 70 mm travel
- Stainless steel casters

DVA CONTRACTED

BE04..... BUY

Prescribers... OT/RN/CA/S/Phys/LMO

For approval rules refer to pg 7.

- Swing back independent armrests with safety arms
- Stainless steel pan rack guides
- Australian Standards approved to 150 kg

Note: Pictured with an optional open seat (BTC066600)

Code	Description	Overall Height	Overall Width	Seat Width	Backrest Height	Armrest Height	Lower Leg Length	Anterior Seat Height	Posterior Seat Height	RAP #:
BTC066050	WB Platform - 530 mm - Att Prop - S/Steel	991 mm	582 mm	530 mm	307 mm	225 mm	395 mm	584 mm	554 mm	BE04
410B100=85000	WB Platform - 530 mm - Self Prop - S/Steel	991 mm	582 mm	530 mm	307 mm	225 mm	395 mm	584 mm	554 mm	-



Option: Open Seat



Option: Armrest - Padded Offset

Weight Bearing Platform 600

This heavy duty commode features a reinforced frame and drop down armrests. The maximum user weight is 400 kg. It is available in an attendant propelled version only.

- Easy foot operated sliding, non-slip, weight bearing platform
- Removable and adjustable seat with 70 mm travel
- Stainless steel casters
- Selection of seamless PU seat, or a soft comfort seat

DVA CONTRACTED

BE04..... BUY

Prescribers... OT/RN/CA/S/Phys/LMO

For approval rules refer to pg 7.

- Drop down heavy duty armrests, including safety arms
- Stainless steel pan rack guides
- Australian Standards approved to 400 kg

Note: Pictured with an optional open seat (BTC066600)

Code	Description	Overall Height	Overall Width	Seat Width	Backrest Height	Armrest Height	Lower Leg Length	Anterior Seat Height	Posterior Seat Height	RAP #:
BTC061400	WB Platform - 600 mm - Att Prop - S/Steel	991 mm	725 mm	603 mm	300 mm	247 mm	400 mm	590 mm	559 mm	BE04



Option: Open Seat



Option: Self Propelling Conversion Kit

Swing Away Footrest 460

This commode includes safety armrests and can be supplied in either a self propelling or attendant propelled version. The frame width is 46 cm.

- Height adjustable, reinforced, swing away footplates
- Removable and adjustable seat with 70 mm travel
- Stainless steel casters
- Selection of seamless PU seat, or a soft comfort seat
- Swing back independent armrests with safety arms

DVA CONTRACTED
BE04 BUY
Prescribers... OT/RN/CA/S/Phys/LMO
For approval rules refer to pg 7.

- Stainless steel pan rack guides
- Australian Standards approved to 150 kg

Note: Pictured with an optional open seat (BTC066600)

Code	Description	Overall Height	Overall Width	Seat Width	Backrest Height	Armrest Height	Lower Leg Length	Anterior Seat Height	Posterior Seat Height	RAP #:
BTC065900	Swing Away Footrest - 460 mm - Att Prop - S/Steel	992 mm	512 mm	460 mm	307 mm	228 mm	492 mm	586 mm	556 mm	BE04
BTC066100	Swing Away Footrest - 460 mm - Self Prop - S/Steel	992 mm	656 mm	460 mm	307 mm	226 mm	492 mm	586 mm	549 mm	BE04



Option: Open Seat



Option: Pan Carrier

Swing Away Footrest 600

This attendant propelled commode includes safety armrests. A quick-release self propelling kit can be retro-fitted. The frame width is 60 cm.

- Height adjustable, reinforced, swing away footplates
- Removable and adjustable seat with 70 mm travel
- Stainless steel casters
- Selection of seamless PU seat, or a soft comfort seat
- Swing back independent armrests with safety arms

DVA CONTRACTED
BE04 BUY
Prescribers... OT/RN/CA/S/Phys/LMO
For approval rules refer to pg 7.

- Stainless steel pan rack guides
- Australian Standards approved to 200 kg

Note: Pictured with an optional open seat (BTC066600)

Code	Description	Overall Height	Overall Width	Seat Width	Backrest Height	Armrest Height	Lower Leg Length	Anterior Seat Height	Posterior Seat Height	RAP #:
BTC061300	Swing Away Footrest - 600 mm - Att Prop - S/Steel	993 mm	652 mm	600 mm	306 mm	230 mm	499 mm	589 mm	559 mm	BE04



Option: Closed Seat



Option: Stump/Legrest Support

Swing Away Footrest 410

This attendant propelled commode includes safety armrests and a fixed headrest. A quick-release self propelling kit can be added. The frame width is 41 cm.

- Height adjustable, reinforced, swing away footplates
- Removable and adjustable seat with 70 mm travel
- Stainless steel casters
- Swing back independent armrests with safety arms

DVA CONTRACTED
BE04 BUY
Prescribers... OT/RN/CA/S/Phys/LMO
For approval rules refer to pg 7.

- Stainless steel pan rack guides
- Note: Pictured with an optional closed seat (BTC066500)

Code	Description	Overall Height	Overall Width	Seat Width	Backrest Height	Armrest Height	Lower Leg Length	Anterior Seat Height	Posterior Seat Height	RAP #:
BTC065800	Swing Away Footrest - 410 mm - Att Prop - S/Steel	1000 mm	475 mm	410 mm	385 mm	200 mm	370 mm	560 mm	535 mm	BE04



Option: Open Seat



Option: Pelvic Strap

Tilt In Space

This attendant propelled commode can be easily tilted to 35° and includes reinforced footplates and a comfort backrest. A standard headrest is included. The frame width is 46 cm.

- 35° of rearward tilt, with a small, stable base
- Height adjustable, reinforced, swing away footplates
- Stainless steel casters
- Removable and adjustable seat with 70 mm travel
- Selection of seamless PU seat, or a soft comfort seat

- Can fit Otto Bock X-style headrest for additional support
- Swing back independent armrests with safety arms
- Stainless steel pan rack guides
- Australian Standards approved to 150 kg

Note: Pictured with an optional open seat (BTC066600)

Code	Description	Overall Height	Overall Width	Seat Width	Backrest Height	Armrest Height	Lower Leg Length	Anterior Seat Height	Posterior Seat Height
BTC066025	Tilt in Space - 460mm - S/Steel	1099 mm	570 mm	460 mm	458 mm	234 mm	493 mm	589 mm	571 mm



Open Seat

- PU seamless seats offer excellent durability and easy cleaning. These are recommended for use in hospitals and other institutions



Closed Seat

- PU seamless seats offer excellent durability and easy cleaning. These are recommended for use in hospitals and other institutions

DVA For eligibility & prescriber info please refer to pg 7.

Code	Description	RAP #:
BTC066600	Open Seat - 460 mm	BE04
BTC066800	Open Seat - 600 mm	BE04

DVA For eligibility & prescriber info please refer to pg 7.

Code	Description	RAP #:
BTC066500	Closed Seat - 410 mm	BE04
BTC066700	Closed Seat - 460 mm	BE04
BTC066900	Closed Seat - 600 mm	BE04



Soft Seat

- Soft seats feature softer foam inners, and are a great solution for those requiring additional pressure relief and comfort



Armrest - Padded Offset

DVA For eligibility & prescriber info please refer to pg 7.

Code	Description	RAP #:
BTC066715	Soft Seat Open - 460 mm	-
BTC066725	Soft Seat Open - 530 mm	BE04
BTC066710	Soft Seat Closed - 460 mm	-
411C100=ST036	Soft Seat Closed - 530 mm	-
411C100=ST037	Soft Seat Closed - 600 mm	-

DVA For eligibility & prescriber info please refer to pg 7.

Code	Description	RAP #:
BTC067000	Armrest - Padded Offset	BE04
411E09=ST049	Bullnose Armrest Pad	-



Pan Carrier



Oxygen Bottle Carrier

DVA For eligibility & prescriber info please refer to pg 7.

Code	Description	RAP #:
BTC066400	Pan Carrier	BE04
BTC066300	Shower Commode Pan Carrier - 410 mm	BE04

DVA For eligibility & prescriber info please refer to pg 7.

Code	Description	RAP #:
BTC067200	Oxygen Bottle Carrier	BE04



Pelvic Strap - Adjustable

✓ DVA For eligibility & prescriber info please refer to pg 7.

Code	Description	RAP #:
BTC067100	Pelvic Strap - Adjustable	BE04



Safety Swing Arm

✓ DVA For eligibility & prescriber info please refer to pg 7.

Code	Description	RAP #:
411A100=ARR1	Safety Swing Arm (Left)	BE04
411A100=ARR2	Safety Swing Arm (Right)	BE04



Self Propelling Conversion Kit

- The Self Propelling Conversion Kit includes rear wheels, anti tippers and brakes
- The wheels are 22" in diameter and feature a quick release axle for easier removal and conversion
- It can be fitted in all commode models, with the exception of the Economy model (410B100=12000) and the 60 cm Platform model (410B100=55000)

Code	Description
411A100=F40PC2	Self Propelling Conversion Kit



Comfort Backrest

- This new backrest is able to be retrofitted to any Otto Bock commode, and features a backrest which is impervious to moisture, will not sag and provides additional postural support

✓ DVA For eligibility & prescriber info please refer to pg 7.

Code	Description	RAP #:
411D100=SV037	Comfort Backrest Belt 41 cm	BE04
411D100=SV038	Comfort Backrest Belt 46 cm	BE04
411D100=SV039	Comfort Backrest Belt 53 cm	BE04
411D100=SV040	Comfort Backrest Belt 60 cm	BE04



Adjustable Thoracic Support

- This support is used for additional trunk support
- Can be fitted to all commodes, with the exception of the 60 cm platform commodes
- Adjustable in height and width

Code	Description
411K100=F4OATA	Adjustable Thoracic Support



Adjustable IV Pole

Code	Description
411S100=F40IVP	Adjustable IV Pole



Standard Headrest

- This headrest comes standard with a comfort headrest pad, and an additional horizontal bracket to enable fitting the Otto Bock X-style headrest bracket which is sold separately
- The headrest is included on the 46 cm Tilt In Space model and can be easily retrofitted to all other commode models

Code	Description
411L100=SK025	Standard Headrest



Stump/Legrest Support

- This support can be used on either the right or left side, and can be positioned to either be an elevating legrest, or a stump support
- Fits on all commodes, with the exception of the 60 cm platform commode

Code	Description
411B100=SK010	Stump/Legrest Support



Otto Bock Commodes Accessories Matrix		Accessories Fit Commode Code(s)									
● Retrofit (can be easily fitted to commode)		BTC066000	BTC066200	BTC066050	Enquiry	BTC061400	BTC065900	BTC066100	BTC061300	BTC065800	BTC066025
Code	Accessory Description										
BTC066600	Open Seat 460	●	●	●	●		●	●			●
BTC066800	Open Seat 600					●			●		
BTC066500	Closed Seat 410									●	
BTC066900	Closed Seat 460	●	●	●	●		●	●			●
BTC066900	Closed Seat 600					●			●		
BTC066715	Soft Seat Open 460	●	●				●	●			●
BTC066725	Soft Seat Open 530			●	●						
Enquiry	Soft Seat Open 600					●			●		
BTC066710	Soft Seat Closed 460	●	●	●	●		●	●			●
411C100=ST036	Soft Seat Closed 530			●	●						
411C100=ST037	Soft Seat Closed 600					●			●		
BTC067000	Offset Armrest Pad	●	●	●	●	●	●	●	●	●	●
411E09=ST049	Bullnose Armrest Pad	●	●	●	●	●	●	●	●	●	●
BTC066400	Pan Carrier 410									●	
BTC066300	Pan Carrier 460	●	●	●	●		●	●			●
411K100=F4OPVS	Pelvic Strap - Adjustable	●	●	●	●	●	●	●	●	●	●
411S100=F400XY	Oxygen Bottle Carrier	●	●	●	●	●	●	●	●	●	●
411A100=F40PC2	Pelvic Strap - Adjustable	●	●	●	●	●	●	●	●	●	●
411A100=F40PC2	Self Propelling Conversion Kit	●	●	●	●		●	●	●	●	●
411D100=SV037	Comfort Backrest Belt 41cm									●	
411D100=SV038	Comfort Backrest Belt 46 cm	●	●	●	●		●	●			●
411D100=SV039	Comfort Backrest Belt 53cm			●	●						
411D100=SV040	Comfort Backrest Belt 60cm					●			●		
411K100=F4OATA	Adjustable Thoracic Support	●	●	●	●		●	●	●	●	●
411L100=SK025	Headrest	●	●	●	●	●	●	●	●	●	
411B100=SK010	Stump/Legrest Support	●	●	●	●		●	●	●	●	●
411S100=F40IVP	Adjustable IV Pole	●	●	●	●	●	●	●	●	●	●
411A100=ARR1	Safety Swing Arm (Left)	●	●	●	●	●	●	●	●	●	●
411A100=ARR2	Safety Swing Arm (Right)	●	●	●	●	●	●	●	●	●	●



Spillproof Urinal

- Assists the user or carer in personal toileting creating more independence
- One-way valve prevents spilling
- Ideal for use while travelling or in the hospital or home



DVA For eligibility & prescriber info please refer to pg 7.

Code	Description	Warranty	RAP #:
BTT148200	Spillproof Male Urinal	12 months	AD04
BTT148300	Female Adaptor	12 months	-



Male Urinal with Lid

- Assists the user or carer in personal toileting creating more independence
- Comes with lid to contain spillage
- Ideal for use in the hospital or home

Code	Description	Warranty
BTT148450	Male Urinal with lid	12 months



Male Urinal

- Assists the user or carer in personal toileting creating more independence
- Ideal for use in the hospital or home



Male Urinal with Screw Lid

- Assists the user or carer in personal toileting creating more independence
- Comes with screw on lid to contain and control spillage
- Ideal for use in the hospital or home

Code	Description	Warranty
BTT145700	Male Urinal Green	12 months
BTT160900	Male Urinal Clear	12 months

Code	Description	Warranty
BTT148400	Male Urinal with Screw Lid	12 months



Female Urinal Cygnet

- Assists the user or carer in personal toileting creating more independence
- Anatomically designed to enable use while sitting, standing or lying
- Ideal for use in the hospital or home



Female Urinal

- Assists the user or carer in personal toileting creating more independence
- Anatomically designed to enable use while sitting, standing or lying

DVA For eligibility & prescriber info please refer to pg 7.

Code	Description	Warranty	RAP #:
BTT148800	Female Urinal Cygnet	12 months	AD04

DVA For eligibility & prescriber info please refer to pg 7.

Code	Description	Warranty	RAP #:
BTT148700	Female Urinal	12 months	AD04



Bed Pan

- Assists toileting of user whilst confined to bed
- Wide seating area and front cut out to allow for correct positioning
- Made of a moulded plastic autoclavable construction
- Fits all K Care shower commodes
- Warranty: 12 months



DVA For eligibility & prescriber info please refer to pg 7.

Code	Description	Supplier Code	RAP #:
BTT151800	Bed Pan	KA11B	BE03



Urinal Bottle Holder

- Urinal bottle holding device for quick storage and convenient access
- Nylon coated and fits easily onto the side of the bed
- Warranty: 12 months



DVA For eligibility & prescriber info please refer to pg 7.

Code	Description	Supplier Code	RAP #:
BTT149000	Urinal Bottle Holder	MC10UBH	AD04



Bed Pan Slipper

- Assists toileting of an immobile user whilst confined to bed
- Wedge shape assists in positioning pan
- Made of a moulded plastic autoclavable construction

DVA For eligibility & prescriber info please refer to pg 7.

Code	Description	Warranty	RAP #:
BTT148000	Bed Pan Slipper	12 months	BE03



Shower Chair with arms (zinc treated)

- Shower chair arms assist transfers
- Fully adjustable seat height and angle to suit user
- Moulded contoured clip on seat for quick assembly, cleaning or replacement
- Fitted with non-slip rubber tips
- Frame options - Zinc treated (anti corrosive) or Aluminium (non corrosive)
- Warranty: 12 months

✓ DVA CONTRACTED
 AZ04..... BUY
 Prescribers... OT/RN/S/Phys/LMO
 For approval rules refer to pg 7.

Code	Description	Frame Width	Seat Width	Seat Depth	Seat Height	Product Weight	Max. User Weight	Supplier Code	✓ RAP #:
BTS114900	Shower Chair with arms (zinc treated)	450 mm	440 mm	430 mm	420 - 550 mm	2.57 kg	110 kg	KA220ZA	AZ04
BTS114950	Shower Chair with arms (aluminium)	450 mm	440 mm	430 mm	420 - 550 mm	2.57 kg	110 kg	KA220AA	AZ04
BTS105600	Shower Chair Extra Wide (zinc treated)	510 mm	500 mm	430 mm	420 - 550 mm	2.57 kg	135 kg	KA220ZA50	AZ04
BTS114700	Shower Chair with arms (S/Steel)	450 mm	440 mm	439 mm	420 - 550 mm	2.57 kg	110 kg	KA220SA	AZ04



Shower Chair no Arms (zinc treated)

- This shower chair has no arms to allow more access for showering
- The chair is equipped with a moulded contoured seat for added comfort and support
- Zinc treated for corrosion resistance

✓ DVA CONTRACTED
 AZ04..... BUY
 Prescribers... OT/RN/S/Phys/LMO
 For approval rules refer to pg 7.

Code	Description	Frame Width	Seat Width	Seat Depth	Seat Height	Product Wt.	Max. User Wt.	Supplier Code	✓ RAP #:
BTS114800	Shower Chair no Arms (zinc treated)	450 mm	440 mm	430 mm	420 - 550 mm	2.15 kg	110 kg	KA220Z	AZ04



Shower Chair without back

- Shower chair no back assists showering access
- Fully adjustable seat height to suit user
- Zinc treated anti corrosive frame
- Open front plastic molded seat to assist personal cleaning
- Fitted with non-slip rubber tips

✓ DVA CONTRACTED
 AZ04..... BUY
 Prescribers... OT/RN/S/Phys/LMO
 For approval rules refer to pg 7.

Code	Description	Frame Width	Seat Width	Seat Depth	Seat Height	Warranty	Max. User Wt.	✓ RAP #:
BTS107160	Shower Chair without back	480 mm	410 mm	400 mm	432 - 508 mm	12 months	110 kg	AZ04



Shower Chair Folding

- Easy to fold up design ideal for use whilst travelling or for storage
- Fitted with non-slip rubber tips
- Fully adjustable seat height to suit user
- Open front plastic molded seat to assist personal cleaning

Code	Description	Frame Width	Seat Width	Seat Depth	Seat Height	Warranty	Max. User Weight
BTS107150	Shower Chair Folding	480 mm	410 mm	400 mm	457 - 533 mm	12 months	110 kg



Shower Chair Maxi

- Reinforced wide frame designed for bariatric use
- Fixed height frame for extra stability
- Fitted with non-slip rubber tips
- Padded seat, armrests and backrest for user comfort and support
- Zinc treated anti corrosive frame
- Warranty: 12 months

DVA CONTRACTED
 AZ04..... BUY
 Prescribers... OT/RN/S/Phys/LMO
 For approval rules refer to pg 7.

Code	Description	Frame Width	Seat Width	Seat Depth	Seat Height	Product Wt.	Max. User Wt.	Supplier Code	RAP #:
BTS105700	Shower Chair Maxi 550 (zinc treated)	680 mm	550 mm	430 mm	520 mm	3.5 kg	300 kg	KA220ZA55	AZ04
BTS105800	Shower Chair Maxi 600 (zinc treated)	730 mm	600 mm	430 mm	520 mm	5.5 kg	300 kg	KA220ZA60	AZ04
BTS105900	Shower Chair Maxi 650 (zinc treated)	780 mm	650 mm	430 mm	520 mm	6.5 kg	300 kg	KA220ZA65	AZ04



Shower Chair Mobile

- Attendant propelled shower chair mounted on rubber castors for maneuverability
- Swing back arms assist with transfers as well as showering access
- 2 castors are locking for stability
- Zinc treated anti corrosive frame
- Warranty: 12 months

DVA CONTRACTED
 AZ04..... BUY
 Prescribers... OT/RN/S/Phys/LMO
 For approval rules refer to pg 7.



Code	Description	Frame Width	Seat Width	Seat Depth	Seat Height	Product Wt.	Max. User Wt.	Supplier Code	RAP #:
BTS116800	Shower Chair Mobile (zinc treated)	460 mm	440 mm	430 mm	530 mm	10 kg	110 kg	KA230Z	AZ04
BTC081100	Sliding Footrest							KA23F	-



Shower Chair No Arms

- Shower chair no arms assists showering access
- Fully adjustable seat height and angle to suit
- Fitted with non-slip rubber tips
- Zinc treated anti corrosive frame
- Moulded contoured clip on seat for quick assembly, cleaning or replacement
- Warranty: 12 months

DVA CONTRACTED
 AZ04..... BUY
 Prescribers... OT/RN/S/Phys/LMO
 For approval rules refer to pg 7.

Code	Description	Frame Width	Seat Width	Seat Depth	Seat Height	Product Wt.	Max. User Wt.	Supplier Code	RAP #:
BTS114800	Shower Chair no Arms (zinc treated)	450 mm	440 mm	430 mm	420 - 550 mm	2.15 kg	110 kg	KA22AWF	AZ04



Shower Chair Cushion

- Specially designed for our range of shower chairs
- Provides added comfort whilst showering

Code	Description	Supplier Code
BTS116400	Shower Chair Cushion	KA22C



Shower Stool with arms

- Shower stool arms assist transfers
- Fully adjustable seat height and angle to suit user
- Fitted with non-slip rubber tips
- Moulded clip on seat for quick assembly, cleaning or replacement
- Frame options - Zinc treated (anti corrosive) or Aluminium (non corrosive)
- Warranty: 12 months

DVA CONTRACTED
 AZ04..... BUY
 Prescribers... OT/RN/S/Phys/LMO
 For approval rules refer to pg 7.

Code	Description	Frame Width	Seat Width	Seat Depth	Seat Height	Product Weight	Max. User Weight	Supplier Code	RAP #:
BTS115200	Shower Stool with arms (zinc treated)	460 mm	350 mm	300 mm	490 - 610 mm	3.25 kg	110 kg	KA222ZA	AZ04
BTS115650	Shower Stool with arms (aluminium)	460 mm	350 mm	300 mm	490 - 610 mm	3.25 kg	110 kg	KA222AA	AZ04
BTS115300	Shower Stool with arms and padded seat (zinc treated)	460 mm	350 mm	300 mm	490 - 610 mm	3.25 kg	110 kg	KA222ZAP	AZ04
BTS116600	Shower Stool Padded Seat	460 mm	350 mm	300 mm	490 - 610 mm	3.25 kg	110 kg	KA22P	-
BTS116300	Padded Backrest for BTS115200,BTS115650 & BTS115300							KA22BA	AZ04



Shower Stool with Fixed Padded Backrest

- Padded backrest for added comfort and support
- Fully adjustable seat height and angle to suit user
- Fitted with non-slip rubber tips
- Moulded clip on seat for quick assembly, cleaning or replacement
- Zinc treated anti corrosive frame
- Warranty: 12 months

DVA CONTRACTED
 AZ04..... BUY
 Prescribers... OT/RN/S/Phys/LMO
 For approval rules refer to pg 7.

Code	Description	Frame Width	Seat Width	Seat Depth	Seat Height	Product Weight	Max. User Weight	Supplier Code	RAP #:
BTS117700	Shower Stool (zinc treated)	460 mm	350 mm	300 mm	490 - 610 mm	3.22 kg	110 kg	KF22210	AZ04



Shower Stool with Strapping

- Unique strapped PVC tube seat provides the user with maximum comfort
- Fully adjustable seat height to suit user
- Fitted with non-slip rubber tips

Code	Description	Frame Width	Seat Width	Seat Depth	Seat Height	Warranty	Product Weight	Max. User Weight
BTS113600	Shower Stool with Strapping	430 mm	410 mm	290 mm	475 - 605 mm	12 months	4.4 kg	100 kg



Shower Stool Wide

- Wide frame (420 mm) gives the user a wider and deeper seat
- Fully adjustable seat height and angle to suit user
- Fitted with non-slip rubber tips
- Clip on seat for quick assembly, cleaning or replacement
- Zinc treated anti corrosive frame
- Warranty: 12 months

DVA CONTRACTED
 AZ04..... BUY
 Prescribers... OT/RN/S/Phys/LMO
 For approval rules refer to pg 7.

Code	Description	Frame Width	Seat Width	Seat Depth	Seat Height	Product Wt.	Max. User Wt.	Supplier Code	RAP #:
BTS115600	Shower Stool Wide (zinc treated)	480 mm	420 mm	360 mm	410 - 535 mm	3.22 kg	110 kg	KA223ZA	AZ04



Shower Stool Maxi

- Reinforced wide frame designed for bariatric use
- Fixed height frame for extra stability
- Fitted with non-slip rubber tips
- Padded waterproof seat for added user comfort
- Zinc treated anti corrosive frame
- Warranty: 12 months

DVA CONTRACTED
 AZ04..... BUY
 Prescribers... OT/RN/S/Phys/LMO
 For approval rules refer to pg 7.

Code	Description	Frame Width	Seat Width	Seat Depth	Seat Height	Product Wt.	Max. User Wt.	Supplier Code	RAP #:
BTS106000	S/ Stool Maxi 550 (zinc treated)	620 mm	550 mm	430 mm	520 mm	11 kg	300 kg	KA222ZA55	AZ04
BTS106100	S/ Stool Maxi 600 (zinc treated)	670 mm	600 mm	430 mm	520 mm	11 kg	300 kg	KA222ZA60	AZ04
BTS106200	S/ Stool Maxi 650 (zinc treated)	720 mm	650 mm	430 mm	520 mm	12 kg	300 kg	KA222ZA65	AZ04



Shower Stool no Arms & Padded Seat

- Shower stool no arms assists showering access
- Fully adjustable seat height and angle to suit user
- Zinc treated anti corrosive frame
- Moulded clip on seat for quick assembly, cleaning or replacement
- Fitted with non-slip rubber tips
- Warranty: 12 months

DVA CONTRACTED
 AZ04..... BUY
 Prescribers... OT/RN/S/Phys/LMO
 For approval rules refer to pg 7.

Code	Description	Seat Width	Seat Depth	Product Height	Max. User Wt.	Supplier Code	RAP #:
BTS115400	Shower Stool no Arms & Padded Seat - 350mm Seat - Zinc	350 mm	300 mm	440 - 610 mm	110 kg	KA222ZP	AZ04
BTS115100	Shower Stool no arms (zinc treated)	350 mm	300 mm	440 - 610 mm	110 kg	KA222Z	AZ04



Shower Stool Maxi Compact

- Reinforced compact design shower stool for the bariatric user
- Fully adjustable seat height to suit user
- Lightweight aluminium construction
- Fitted with non-slip rubber foot pads

DVA CONTRACTED
 AZ04..... BUY
 Prescribers... OT/RN/S/Phys/LMO
 For approval rules refer to pg 7.

Code	Description	Seat Width	Seat Depth	Seat Height	Max. User Weight	RAP #:
BTS105200	Shower Stool Maxi Compact	510 mm	380 mm	380 - 480 mm	227 kg	AZ04



Wall - Mounted Shower Seat (Economy)

- Shower seat installs against shower wall for support, comfort and safety while showering
 - Solid plastic seat made from epoxy coated mild steel
 - Folds away against the wall
 - Weight capacity dependant on fixing method
 - Zinc treated anti corrosive frame
 - Warranty: 12 months
- Note: shower seats should be installed by a qualified tradesperson

DVA CONTRACTED
 AZ03..... BUY
 Prescribers... OT/RN/S/LMO
 For approval rules refer to pg 7.

Aidacare Home Modification Services

Code	Description	Seat Width	Seat Depth	Product Weight	Max. User Wt.	Supplier Code	RAP #:
BTS115800	Shower Seat Economy	350 mm	300 mm	2 kg	100 kg	KA228E	AZ03



Wall - Mounted Shower Seat

- Adjustable leg for added strength and allows for variable seat angle
- Folds away against the wall
- Weight capacity dependant on fixing method
- Durable stainless steel frame
- Warranty: 12 months
- BTS 116100 is designed to comply with Australian standards AS14281

Note: shower seats should be installed by a qualified tradesperson

✓ DVA CONTRACTED
 AZ03 BUY
 Prescribers... OT/RN/S/LMO
 For approval rules refer to pg 7.

Aidacare Home Modification Services

Code	Description	Seat Width	Seat Depth	Seat Height	Product Weight	Max. User Wt.	Supplier Code	✓ RAP #:
BTS115700	Shower Seat Small	350 mm	300 mm	480 mm	3 kg	125 kg	KA229	AZ03
BTS115900	Shower Seat Large	700 mm	450 mm	480 mm	5 kg	125 kg	KA229A	AZ03
BTS116100	Shower Seat Large AS	960 mm	400 mm	480 mm	7 kg	125 kg	KA228	AZ03



Sitz Bath Chair

- Sit-in wash bath for therapeutic personal washing or cleansing, particularly post child birth
- Durable fibreglass construction
- Inbuilt plug and drain fitted with directional hose for improved drainage

✓ DVA CONTRACTED
 BE01 BUY (P.A Rqd)
 Prescribers... OT/RN/CA/S/LMO
 For approval rules refer to pg 7.

Code	Description	Seat Width	Seat Depth	Seat Height	Warranty	Product Weight	Max. User Wt.	✓ RAP #:
BTS119700	Sitz Bath Chair	580 mm	380 mm	560 mm	12 months	7 kg	125 kg	BE01



Shower Chair & Commode Chair Belt

- Assists support the pelvic position of the user whilst in the mobile shower commode
- Modifications may be required as this is a custom made commode fitting

Code	Description	Warranty
BTS124500	Shower Chair Belt	12 months



Body Point Shower Belt

- Assists support the user and carer during showering
- Bodypoint shower chair belt uses Aeromesh TM fabric and dries quickly after use
- Water and air easily pass through fabric so user can be bathed completely
- Universal shape for flexibility of use depending on needs
- Can be fitted across the chest, abdomen, knees or legs to prevent forward or lateral falls and for slippage

✓ DVA CONTRACTED
 AZ04 BUY
 Prescribers... OT/RN/S/Phys/LMO
 For approval rules refer to pg 7.

Code	Description	Clamp Size	Warranty	✓ RAP #:
BTS117730	Shower Belt Medium with Clamp 22	22 mm	12 months	AZ04
BTS117735	Shower Belt Large with Clamp 22	22 mm	12 months	AZ04
BTS117732	Shower Belt Medium with Clamp 25	25 mm	12 months	AZ04
BTS117734	Shower Belt Large with Clamp 25	25 mm	12 months	AZ04



Fresh Bath Board

- The Fresh bath board provides a stable seat over the bath when bathing or showering
- Features an easy grip handle for secure transfers, non slip surface, drainage holes and adjustable legs to fit a large size of tubs

DVA CONTRACTED
 AZ01..... BUY
 Prescribers... OT/RN/S/LMO
 For approval rules refer to pg 7.

Code	Description	Width	Depth	Warranty	Product Weight	Max. User Weight	RAP #:
BTS113700	Fresh Bath Board	690 mm	350 mm	12 month	3 kg	150 kg	AZ01



Bath Transfer Bench Padded

- Padded seat & backrest provides a cushioned surface for comfort
- Highly resilient vinyl covering
- Fully height adjustable with a side arm for secure transfers
- Adjustable backrest to suit right or left facing tubs
- Suction cup foot pieces secure the bench to the tub floor
- Lightweight aluminium frame construction

DVA CONTRACTED
 AZ01..... BUY
 Prescribers... OT/RN/S/LMO
 For approval rules refer to pg 7.

Code	Description	Total Width	Total Depth	Seat Width	Seat Depth	Seat Height	Product Weight	Max. User Wt.	RAP #:
BTS110900	Bath Transfer Bench, Padded	770 mm	530 mm	670 mm	410 mm	410 - 530 mm	7.5 kg	136 kg	AZ01
BTS108200	Bath Transfer Bench, Plastic	770 mm	530 mm	670 mm	410 mm				AZ01
BTS108300	Leg Extension Options								-



Bath Transfer Bench Bariatric

- Reinforced design for the bariatric user with a maximum weight of 227 kg
- It has a textured molded plastic seat and backrest
- Fully height adjustable with a side arm for secure transfers
- Adjustable backrest to suit right or left facing tubs
- Suction cup foot pieces secure the bench to the tub floor
- Lightweight aluminium frame construction

DVA CONTRACTED
 AZ01..... BUY
 Prescribers... OT/RN/S/LMO
 For approval rules refer to pg 7.

Code	Description	Total Width	Total Depth	Seat Width	Seat Depth	Seat Height	Product Weight	Max. User Wt.	RAP #:
BTS105300	Bath Transfer Bench Bariatric	775 mm	584 mm	670 mm	410 mm	390 - 520 mm	7.2 kg	227 kg	AZ01



Swivel Bather Shower Chair

- The Swivel Bather Chair's rotating seat allows for easy transfer over the bath/shower
- Fully height adjustable floor standing base unit
- Can be removed instantly for normal shower use
- The Swivel Bather's rotating seat allows for easy transfer over the bath for showering or bathing
- Chair attaches to all standard bath sizes/styles and can be removed instantly for normal bath use
- Spacers available to adjust bather height



DVA For eligibility & prescriber info please refer to pg 7.

Code	Description	Seat Width	Seat Height	Width over bath	Length	Warranty	Product Weight	Max. User Weight	RAP #:
BTS107100	Swivel Bather Chair	445 mm	430 - 510 mm			12 months		100 kg	AZ01
BTS106500	Bath Chair Swivel Bather	445 mm		710 mm	660 mm	12 months	5.5 kg	100 kg	AZ01
BTS106800	Bath Chair Acc - Swivel Bather Spacer 3" (75 cm)								AZ01
BTS106900	Bath Chair Acc - Swivel Bather Spacer 6" (150 cm)								AZ01



Bath/Shower Board - Padded Seat

- Covered in grey PVC over thick foam giving excellent comfort
- Rounded corners add to the luxury finish, and welded seams prevent ingress of water

✓ DVA CONTRACTED

AZ01..... BUY

Prescribers... OT/RN/S/LMO

For approval rules refer to pg 7.

Code	Description	Length	Width	Max. User Weight	✓ RAP #:
BTS111200	Bath/Shower Board - w/ Padded Seat - 670 mm	670 mm	240 mm	127 kg	AZ01
BTS111300	Bath/Shower Board - w/ Padded Seat - 730 mm	730 mm	240 mm	127 kg	AZ01



Bath/Shower Board - Savannah - Slatted Seat

- A slatted, plastic and wood, adjustable bath board
- Featuring a curved plastic securing bracket under each end
- Slip resistant grips on the underside of the board provide additional slip resistance on the bath edge

✓ DVA CONTRACTED

AZ01..... BUY

Prescribers... OT/RN/S/LMO

For approval rules refer to pg 7.

Code	Description	Surface Area	✓ RAP #:
BTS111900	Bath/Shower Board - Savannah - Slatted Seat	689 x 356 mm	AZ01
BTS111700	Bath/Shower Board - Savannah - Slatted Seat - Large 190 kg	689 x 356 mm	AZ01
BTS112100	Bath/Shower Board - Savannah - Slatted Seat	689 x 200 mm	AZ01



Bath/Shower Board - Rentwood - Plastic Wedge Seat

- Two hinged adjustable side
- Suitable for metal or ceramic bathtubs
- Seat measures 40 x 22 cm, width adjusts from 42.5 to 49 cm in 1.6 m increments

✓ DVA CONTRACTED

AZ01..... BUY

Prescribers... OT/RN/S/LMO

For approval rules refer to pg 7.

Code	Description	Surface Area	✓ RAP #:
BTS112200	Bath/Shower Board - Rentwood - Plastic wedge seat	400 x 220 mm	AZ01



Bath Step

- Assists with daily activities, especially getting into and out of the bath
- Large textured surface gives the user confidence and provides additional safety
- Modular construction allows flexibility of design by creating a larger or smaller step by adding on top or clipping together
- Each additional step adds 50 mm to the height of the step, up to a maximum of six steps equal to 355 mm
- Foam pad fits neatly onto the surface of the step, making it warm and soft underfoot
- Cut-away hand space for easy lifting

✓ DVA CONTRACTED

AZ01..... BUY

Prescribers... OT/RN/S/LMO

For approval rules refer to pg 7.

Code	Description	Surface Area	Footprint	Warranty	Product Weight	Max. User Wt.	✓ RAP #:
BTS112750	Bath Step Modular	356 x 457 mm	381 x 483 mm	12 months	1.3 kg	190 kg	AZ01



Bathmaster Sonaris

- Electric bathmaster designed to overcome difficulties getting in and out of the bath
- Can be used in all standard baths
- Sucker feet that may be angled in any direction to suit the curvature of the bath to ensure stability and safety in use
- Contoured seat and backrest for support and comfort. May be used with or without the covers
- Two lightweight components that simply click together facilitating quick and simple assembly, installation and removal
- Easily operated by lightly pressing the large control pads, which are textured to assist the visually impaired
- A built in safety mechanism ensures the bathlift will not lower if there is insufficient charge in the battery to raise the user
- Both user and carer will benefit from safe independent bathing
- Smooth steady action plus a transition interval between reaching the base of the bath and reclining allows the user to remain in a controlled position increasing confidence and security
- The preferred angle of recline can be selected by the user enabling the most comfortable and suitable position to be chosen

Note: Recommended to be used with covers (purchased separately). These attach to seat for added comfort and support



Code	Description	Seat size	Backrest size	Height range	Warranty	Product Weight	Max. User Weight	Product Weight
BTS112700	Bathmaster Sonaris	510 x 680 mm	615 x 355 mm	75 - 455 mm	12 months	17.23 kg	140 kg	7.2 kg
BTS112301	Bathmaster Sonaris Covers							
BTS112600	Bathmaster Side Flaps							



Aqua Joy

- Allows the client to recline in the bath like they used to
- Separates easily into two compact sections
- No awkward locks or buttons to press, backrest simply folds forward to detach
- Suitable for deep baths - maximum seat height 460 mm
- Suitable for shallow baths - minimum seat height 80 mm
- Can be used with or without covermats - Detachable and can be washed in a standard washing machine up to 60 degrees protecting against unwanted germs and bacteria
- Easy release suction feet with lifting bar as standard
- Lightweight, Waterproof, Floating hand control



Code	Description	Code	Description
BTS112710	Aqua Joy	BTS112716	Lap Harness
BTS112711	Swivel & Slide	BTS112718	Headrest
BTS112714	Pommel	BTS112713	Upper Body Support Wings
BTS112715	Wedge Cushion	BTS112712	Unique Gell Filled Covered Mats
BTS112715	Chest Harness		



Refer to page 182 - 183 for other waterproof protectors by LimbO

Cast & Bandage Protector

- Reusable, nonlatex rubber diaphragm stretches easily over a cast or bandage creating a watertight seal
- Keep your cast dry whilst bathing or showering

✓ DVA CONTRACTED
 AZ06..... BUY
 Prescribers... OT, RN, S/LMO
 For approval rules refer to pg 7.

Code	Description	Height	✓ RAP #:
BTS109100	Cast Protector Short Arm	560 mm	AZ06
BTS109200	Cast Protector Long Arm	990 mm	AZ06
BTS109300	Cast Protector Short Leg	590 mm	AZ06
BTS109400	Cast Protector Long Leg	1070 mm	AZ06
BTS109500	Cast Protector Foot/Ankle	280 mm	AZ06



Bath Sponge

- For bath or shower washing flexibility and independence
- Absorbent sponge attached to 24" long reaching stem and grip
- Allows easy reaching to the legs, feet and back
- Flexible enough to bend to any shape and reduces bending at the hip

✓ DVA CONTRACTED
 AZ05..... BUY
 Prescribers... OT/Pod/LMO/RN/S/Phys
 For approval rules refer to pg 7.

Code	Description	Warranty	✓ RAP #:
BTS112800	Bath Sponge	12 months	AZ05



Bath Sponge Economy

- For bath or shower washing flexibility and independence
- Absorbent sponge with reaching handle
- Handy long handle to increase bathing independence
- Ideal for users with limited movement or trying to reduce bending at the hip

✓ DVA CONTRACTED
 AZ05..... BUY (P.A Rqd)
 Prescribers... OT/LMO/RN/S
 For approval rules refer to pg 7.

Code	Description	Warranty	✓ RAP #:
BTS111100	Bath Sponge Economy	12 months	AZ05



Toe Washer

- For washing and drying between the toes
- Long stem with plastic built up handle and a wire frame covered in a white towelling pad
- Designed to assist people with limited flexibility or access to their feet
- Includes 2 towelling pads

✓ DVA CONTRACTED
 AU10..... BUY
 Prescribers... OT/LMO/RN/S
 For approval rules refer to pg 7.

Code	Description	Warranty	✓ RAP #:
BTS113000	Toe Washer	12 months	AU10





Bath & Shower Mats

- Prevents slipping in the bath or shower
- Non slip rubber surface increases grip under foot
- Moulded suction cups on underside attach to bath or shower surface

Code	Description	Length	Width	Warranty
BTS110200	Bath Mat	580 mm	340 mm	12 months
BTS109600	Shower Mat	530 mm	530 mm	12 months



Mobile Shower Trolley

- Allows a user with limited mobility to shower and bathe with the assistance of a carer
- Hydraulically operated fully height adjustable frame with dual pedals on both sides to suit a range of washing heights
- Stainless steel frame and push handle with aluminium bed frame
- 4 lockable castors for manoeuvrability and stability
- Also available in an electric version (BTS117804)
- Warranty: 24 months

Code	Description	Length	Width	Height	Product Weight	Max. User Weight	Supplier Code
BTS117800	Mobile Shower Trolley	1850 mm	800 mm	500 - 955 mm	63 kg	150 kg	KH600
BTS117801	Mobile Shower Trolley Small	1550 mm	800 mm	500 - 955 mm	58 kg	150 kg	KH600ES
BTS117802	Mobile Shower Trolley Xtra Long	2000 mm	800 mm	500 - 955 mm	68 kg	150 kg	KH600EL
BTS117803	Mobile Shower Trolley Xtra Wide	1850 mm	1000 mm	500 - 955 mm	68 kg	150 kg	KH600EW
BTS117804	Mobile Shower Trolley Electric	1850 mm	800 mm	500 - 955 mm	63 kg	150 kg	KH600E



Mobile Change Table

- Electrically operated height-adjustable mobile change table
- Features rapid high/low adjustment operated with electric foot switch
- Four 100 mm heavy duty castors
- Mediflex upholstered top
- Warranty: 24 months

Code	Description	Length	Width	Height	Max. User Weight	Supplier Code
BTS118200	Mobile Change Table	1800 mm	700 mm	575 - 995 mm	130 kg	KH605
BTS118300	Change Table Strap Rail					KH605S
BTS118400	Change Table Side Rail					KH605SR
BTS125300	Change Table - Mobile - Hydraulic					KH604



Hand Held Shower Push on Single

- Flexible shower head with single push on attachment assists showering
- Gentle flow shower head for sensitive skin
- High pressure clamp for attaching to tap
- Available in two lengths

✓ DVA CONTRACTED
AZ02..... BUY
Prescribers... OT/RN/S/LMO
For approval rules refer to pg 7.

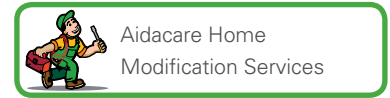

Code	Description	Length	Warranty	✓ RAP #:
BTS114400	Hand Held Shower Push on Single	1.25 m	12 months	AZ02
BTS114500	Hand Held Shower Push on Single	2 m	12 months	AZ02



Hand Held Shower push on Dual

- Flexible shower head with dual push on attachment for hot & cold assists showering
- Gentle flow shower head for sensitive skin
- High pressure clamp for attaching to tap
- Available in two lengths

✓ DVA CONTRACTED
AZ02..... BUY
Prescribers... OT/RN/S/LMO
For approval rules refer to pg 7.

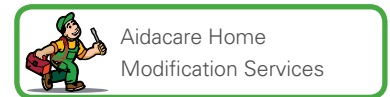

Code	Description	Length	Warranty	✓ RAP #:
BTS114200	Hand Held Shower push on Dual	1.25 m	12 months	AZ02
BTS114300	Hand Held Shower push on Dual	2 m	12 months	AZ02



Hand Held Shower

- Allows for ease of cleaning with its long flexible reinforced hose
- Can replace existing shower outlet or can be installed to allow use of both
- Extension hoses available

Note: check suitability for fit, recommended to be installed by authorised service person

✓ DVA CONTRACTED
AZ02..... BUY
Prescribers... OT/RN/S/LMO
For approval rules refer to pg 7.

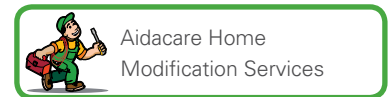

Code	Description	Length	Warranty	✓ RAP #:
BTS107200	Hand Held Shower 1.5	1.5 m	12 months	AZ02
BTS107300	Hand Held Shower 2.0	2.0 m	12 months	AZ02
BTS107400	Switchcock (Allows use of both the hand held shower and existing showerhead)			AZ02



Hand Held Shower on Rail

- Attaches to an adjustable rail enabling the user to position the shower head as preferred
- Allows for ease of cleaning with its long flexible reinforced hose
- Replaces existing shower outlet, extension hoses available

Note: check suitability for fit, recommended to be installed by authorised service person

✓ DVA CONTRACTED
AZ02..... BUY
Prescribers... OT/RN/S/LMO
For approval rules refer to pg 7.

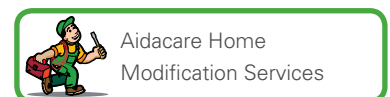

Code	Description	Warranty	✓ RAP #:
BTS107500	Hand Held Shower on Rail	12 months	AZ02



Over Toilet Aid

- Provides a raised seat and support to assist with toileting and transfers suit user
- Fully adjustable seat height to suit user
- Fitted with non-slip rubber tips
- Removable lift back seat for easy cleaning, comes standard with splash guard
- Frame options - Zinc treated (anti corrosive) or Aluminium (non corrosive)

DVA CONTRACTED
 BE06..... BUY
 Prescribers... OT/RN/CA/S/Phys/LMO
 For approval rules refer to pg 7.

• Warranty: 12 months

Code	Description	Seat Width	Seat Depth	Seat Height	Product Weight	Max. User Wt.	Supplier Code	RAP #:
BTT153200	O/ Toilet Aid, Zinc Treated	445 mm	420 mm	480 - 620 mm	3.22 kg	110 kg	KA410Z	BE06
BTT153220	O/ Toilet Aid, Aluminium	445 mm	420 mm	480 - 620 mm	3.22 kg	110 kg	KA410AA	BE06
BTT153600	O/ Toilet Aid w/ pdd seat, Zinc Treated	445 mm	420 mm	480 - 620 mm	3.22 kg	110 kg	KA410ZP	BE06



Over Toilet Aid U Frame

- U Frame features a quick and easy spring and button assembly and removable moulded toilet seat
- Fully adjustable seat height to suit user
- Fitted with non-slip rubber tips
- Removable lift back seat for easy cleaning, comes standard with splash guard
- Frame is galvanized internally and externally for superior corrosion resistance
- Warranty: 12 months

DVA CONTRACTED
 BE06..... BUY
 Prescribers... OT/RN/CA/S/Phys/LMO
 For approval rules refer to pg 7.

Code	Description	Seat Width	Seat Depth	Seat Height	Product Weight	Max. User Wt.	RAP #:
BTT156700	Over Toilet Aid U Frame	510 mm	420 mm	490 - 610 mm	4.5 kg	110 kg	BE06
BTT156600	Splash Guard to Suit	N/A	N/A	N/A	3.22 kg	110 kg	-



Over Toilet Aid Extra Wide

- Extra wide and reinforced frame accommodating the larger user with seat width of 500 mm
- Fully adjustable seat height to suit user
- Fitted with non-slip rubber tips
- Removable lift back seat for easy cleaning, comes standard with splash guard
- Zinc treated anti corrosive frame
- Warranty: 12 months

DVA CONTRACTED
 BE06..... BUY
 Prescribers... OT/RN/CA/S/Phys/LMO
 For approval rules refer to pg 7.

Code	Description	Seat Width	Seat Depth	Seat Height	Product Weight	Max. User Weight	RAP #:
BTT146300	Over Toilet Aid Extra Wide, Zinc Treated	500 mm	420 mm	480 - 620 mm	3.6 kg	135 kg	BE06



Over Toilet Aid Maxi

- Extra wide and reinforced mild steel tubing frame accommodating maximum user weights up to 300 kg
- Fixed height frame for further strength and stability
- Removable lift back seat for easy cleaning, comes standard with splash guard
- Fitted with non-slip rubber tips
- Zinc treated anti corrosive frame
- Warranty: 12 months

DVA CONTRACTED
 BE06..... BUY
 Prescribers... OT/RN/CA/S/Phys/LMO
 For approval rules refer to pg 7.

Code	Description	Seat Width	Seat Depth	Seat Height	Product Weight	Max. User Weight	RAP #:
BTT146400	Over Toilet Aid Maxi 55 (zinc treated)	550 mm	420 mm	520 mm	4.2 kg	300 kg	BE06
BTT146500	Over Toilet Aid Maxi 60 (zinc treated)	600 mm	420 mm	520 mm	5.5 kg	300 kg	BE06
BTT146600	Over Toilet Aid Maxi 65 (zinc treated)	650 mm	420 mm	520 mm	6.5 kg	300 kg	BE06



Over Toilet Aid Folding

- Easy to fold up design ideal for use whilst travelling or for storage
- Fully adjustable seat height to suit user
- Fitted with non-slip rubber tips
- Removable lift back seat for easy cleaning, comes standard with splash guard
- Zinc treated anti corrosive frame
- Warranty: 12 months

DVA CONTRACTED
 BE06 BUY
 Prescribers... OT/RN/CA/S/Phys/LMO
 For approval rules refer to pg 7.

Code	Description	Seat Width	Seat Depth	Seat Height	Product Wt.	Max. User Wt.	Supplier Code	RAP #:
BTT154700	Over Toilet Aid Folding, Zinc Treated	445 mm	420 mm	480 - 620 mm	4 kg	110 kg	KA430Z	BE06



Splash Guard

- Replacement splash guard to suit all over toilet aids
- Warranty: 12 months

DVA BE11 Parts

Code	Description	Supplier Code
BTT153900	Splash Guard	KA41SN



Toilet Seat Flap

- Replacement toilet seat flap to suit all over toilet aids
- Warranty: 12 months

DVA BE11 Parts

Code	Description	Supplier Code
BTT154100	Toilet Seat Flap	KA41TW



Toilet Surround

- Frame provides assistance in transferring on and off the toilet safely
- Fully adjustable height to suit user and toilet
- Fitted with non-slip rubber tips
- Phosphate treated anti corrosive frame
- Warranty: 12 months

DVA CONTRACTED
 BE06 BUY
 Prescribers... OT/RN/CA/S/Phys/LMO
 For approval rules refer to pg 7.

Code	Description	Frame Width	Height	Product Weight	Max. User Weight	Supplier Code	RAP #:
BTT155000	Toilet Surround	450 mm	660 - 790 mm	3.2 kg	110 kg	KA440	BE06



Bowl with Handle & Lid

- Commode bowl and lid with handle for transportation
- Autoclavable for sanitising
- Moulded plastic construction
- Suits all bedside commode range

DVA CONTRACTED
 BE03 BUY
 Prescribers... OT/RN/CA/S/LMO
 For approval rules refer to pg 7.

Code	Description	Product Weight	Warranty	RAP #:
BTC081600	Bowl with Handle & Lid	0.41 kg	12 months	BE03



Portable Bidet

- A strong plastic bowl that has a soap dish at the front and fits inside most toilet bowls to create a bidet

✓ DVA CONTRACTED
 BE01 BUY (P.A Rqd)
 Prescribers... OT/RN/CA/S/LMO
 For approval rules refer to pg 7.

Code	Description	Width	Length	✓ RAP #:
BTT150500	Portable Bidet	340 mm	350 mm	BE01



Bottom Wiper

- Assists the user with personal cleaning after toileting
- Moulded plastic head with recessed serrations to grip the paper
- Mounted on a lightweight curved handle it is designed to be used from the front
- Paper easily removed after use

✓ DVA CONTRACTED
 AU01 BUY
 Prescribers... OT/LMO/RN/S/Phys
 For approval rules refer to pg 7.

Code	Description	Warranty	✓ RAP #:
BTT150600	Bottom Wiper	12 months	AU01



Bottom Wiper Folding

- Folds into three for easier storage
- Moulded plastic head with recessed serrations to grip the paper
- Mounted on a lightweight curved handle it is designed to be used from the front
- Paper easily removed after use

✓ DVA CONTRACTED
 AU01 BUY
 Prescribers... OT/LMO/RN/S/Phys
 For approval rules refer to pg 7.

Code	Description	Warranty	✓ RAP #:
BTT150700	Bottom Wiper Folding	12 months	AU01



Potty Chair

- The freestanding potty chair assists the user with limited mobility to comfortably toilet or shower
- Contoured fibreglass moulded shell seat, supplied standard with pelvic harness
- Fitted with non-slip rubber tips
- Powder coated mild steel frame that is zinc treated for corrosion resistance
- Accessories available including footrest, harness and chest strap
- Zinc treated for corrosion resistance
- Warranty: 12 months

✓ DVA CONTRACTED
 BE07 BUY (P.A Rqd)
 Prescribers... OT/S/CA/RN/LMO
 BE03 BUY
 Prescribers... OT/RN/CA/S/LMO
 For approval rules refer to pg 7.

Code	Description	Seat Width	Seat Height	Product Weight	Max. User Weight	Supplier Code	✓ RAP #:
BTT151900	Potty Chair - Adult	490 mm	410 mm	9 kg	120 kg	KA150A	BE07
BTT152100	Potty Chair - Junior	370 mm	340 mm	6 kg	100 kg	KA150J	-
PED478380	Potty Chair - Child	310 mm	310 mm	7 kg	100 kg	KA150C	-
BTT158500	Potty Suit Chair					KA150P	BE03
BTC080900	Potty Chair Harness					KA15S	-
BTT158600	Potty Chest Strap 1 Piece with Buckle					KA15CST	BE03
BTT152500	Potty Chair Chest Strap					KA15CSTF	BE07
BTT152400	Potty Chair Adult Footrest					KA15AFP	BE07
BTT152600	Potty Chair Junior Footrest					KA15JF	-
BTT155500	Potty Chair Junior Tray					KA70J	-



Potty Chair Mobile

- Four castor wheels (two locking) provide the carer with a convenient mobile chair and a height adjustable frame
- Contoured fibreglass moulded shell seat, supplied standard with pelvic harness
- Powder coated mild steel frame that is zinc treated for corrosion resistance

DVA CONTRACTED
 BE07 BUY (P.A Rqd)
 Prescribers... OT/S/CA/RN/LMO
 For approval rules refer to pg 7.

Code	Description	Seat Width	Seat Height	Product Weight	Max. User Weight	Supplier Code	RAP #:
BTT152000	Potty Chair Adult Mobile	490 mm	410 mm	9 kg	120 kg	KA150AM	BE07
BTT152200	Potty Chair Junior Mobile	370 mm	340 mm	6 kg	100 kg	KA150JM	-
BTT152700	Potty Chair Adj Height Legs					KA15L	-



Potty Chair Tilt In Space

- Tilt In Space mechanism encourages correct patient positioning and work posture for carers
- Contoured fibreglass moulded shell seat, supplied standard with pelvic harness
- Powder coated mild steel frame that is zinc treated for corrosion resistance
- Supplied standard with a pelvic harness, other accessories include footrest and chest strap
- Warranty: 12 months

Code	Description	Seat Width	Seat Height	Product Weight	Max. User Weight	Supplier Code
BTT152300	Potty Chair Tilt In Space Jr	370 mm	655 mm	10 kg	100 kg	KA150JR



Travel Disposable Urinal

- This is a disposable urinal that is convenient, sanitary, discrete and compact
- It features a unisex adapter making it easy for anyone to use whilst standing or sitting
- Each box contains three urinals

Code	Description
BTT157400	Travel Disposable Urinal



Toilet Seat Raiser

- Assists toileting and transfers by raising the toilet seat height
- Moulded plastic seat sits securely over the existing toilet
- Fits all standard toilet seats
- Adjustable mounting brackets to allow for correct fitting to different size toilets

DVA CONTRACTED
 BE10 BUY
 Prescribers... OT/RN/Phys/S/LMO
 For approval rules refer to pg 7.

Code	Description	Height	Warranty	Max. User Weight	RAP #:
BTT149800	Toilet Seat Raiser 50	50 mm	12 months	190 kg	BE10
BTT150200	Toilet Seat Raiser 100	100 mm	12 months	190 kg	BE10
BTT150300	Toilet Seat Raiser 150	150 mm	12 months	190 kg	BE10



Toilet Seat Raiser with Lid

- Moulded plastic seat raiser with plastic lid to mask odours
- Fits all standard toilet seats
- Adjustable mounting brackets to allow for correct fitting to different size toilets
- Available in three different height versions to suit individual requirements

DVA CONTRACTED
 BE10 BUY
 Prescribers... OT/RN/Phys/S/LMO
 For approval rules refer to pg 7.

Code	Description	Height	Warranty	Max. User Wt.	RAP #:
BTT149900	Toilet Seat Raiser with Lid 50	50 mm	12 months	190 kg	BE10
BTT150100	Toilet Seat Raiser with Lid 100	100 mm	12 months	190 kg	BE10
BTT150400	Toilet Seat Raiser with Lid 150	150 mm	12 months	190 kg	BE10



Bathtub Grabrail

- Bathtub Grabrail provides a firm handle at the bath side for user confidence and stability
- Increases safety during transfers
- Rubber pads for security and protection
- Adjustable clamps to suit a large range of tub sizes and edges
- Warranty: 12 months

✓ DVA CONTRACTED
AL09 BUY (P.A Rqd)
Prescribers... OT/S/LMO
For approval rules refer to pg 7.

Aidacare Home Modification Services

Code	Description	Height	Depth	Product Weight	Max. User Wt.	✓ RAP #:
BTS108100	Bathtub Grabrail	680 mm	300 mm	3 kg	190 kg	AL09



Devon Folding Support Rail

- Sturdy folding rail provides additional support for bathroom transfers
 - Baseplate securely mounted on the wall, rail is held upright by a spring loaded cam and folds down when not in use
 - Rail is 25 mm (1") diameter. Backplate is 300 x 125 mm (11 & frac34; x 5")
 - Warranty: 12 months
- Note: Check suitability for fit. Recommended to be installed by an authorised service person.

✓ DVA CONTRACTED
AL09 BUY (P.A Rqd)
Prescribers... OT/S/LMO
For approval rules refer to pg 7.

Aidacare Home Modification Services

Code	Model	Rail Length	Product Weight	Max. User Wt.	✓ RAP #:
BTT149300	Devon Folding Support Rail	760 mm	2.62 kg	66.6 kg	AL09
BTT149200	Support Frame Devon Folding 55 cm				AL09



Devon MKII Folding Support Rail

- Baseplate securely mounted on the wall, rail is held upright by a spring loaded cam and folds down when not in use
 - Optional toilet roll holder
 - A deluxe version of the Devon rail with a large diameter rail for easier gripping
 - Warranty: 12 months
- Note: Check suitability for fit. Recommended to be installed by an authorised service person.

✓ DVA CONTRACTED
AL09 BUY (P.A Rqd)
Prescribers... OT/S/LMO
For approval rules refer to pg 7.

Aidacare Home Modification Services

Code	Description	Rail Length	Product Weight	Max. User Wt.	✓ RAP #:
BTT149400	Devon MKII Folding Support Rail	760 mm	4.1 kg	83.9 kg	AL09
BTT149700	Toilet Roll Holder				AL09



Devon Rail with Folding Leg

- Support leg gives strength and stability during lowering and raising, lessening strain on the wall
 - Fully adjustable height leg (790 - 985 mm) and has a large non slip ferrule
 - Baseplate securely mounted on the wall, rail is held upright by a spring loaded cam and folds down when not in use
 - Warranty: 12 months
- Note: Check suitability for fit. Recommended to be installed by an authorised service person.

✓ DVA CONTRACTED
AL09 BUY (P.A Rqd)
Prescribers... OT/S/LMO
For approval rules refer to pg 7.

Aidacare Home Modification Services

Code	Description	Rail Length	Product Weight	Max. User Wt.	✓ RAP #:
BTT149500	Devon Rail with Folding Leg	760 mm	5 kg	66.6 kg	AL09
BTT149600	Devon Rail - Floor Mounted				AL09



Throne Grab Rail

- Attaches firmly to the toilet bowl, independent of wall or floor support
- Adjustable mounting brackets to allow for correct fitting to different size toilets
- Grab rail support frame enables secure access toileting and promotes user independence whilst assisting carers

Code	Description	RAP #:
BTT157100	Throne Grab Rail Powder Coated - 3 in 1	BE06
BTT157101	Throne Grab Rail Stainless Steel - 3 in 1	BE06
BTT157105	Throne Grab Rail Wraparound Powder Coated	-
BTT157106	Throne Grab Rail Wraparound Stainless Steel	-
BTT157116	Throne Spacer Bracket	-
BTT157110	Throne Spacer 50 mm	BE10
BTT157115	Throne Spacer 80 mm	BE10

DVA CONTRACTED

BE06 BUY
Prescribers... OT/RN/CA/S/Phys/LMO

BE10 BUY
Prescribers... OT/RN/Phys/S/LMO

For approval rules refer to pg 7.

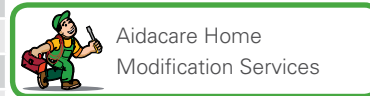

Canterbury Concepts Modular Rails

- Canterbury Concepts rails comply with Australian Standard AS1428.1 - Design for access and mobility
- When installed correctly rails can withstand 1100 N or 110 kg
- Rails feature a unique slip resistant surface
- Modular design allows easy configuration to any household



Common Configurations

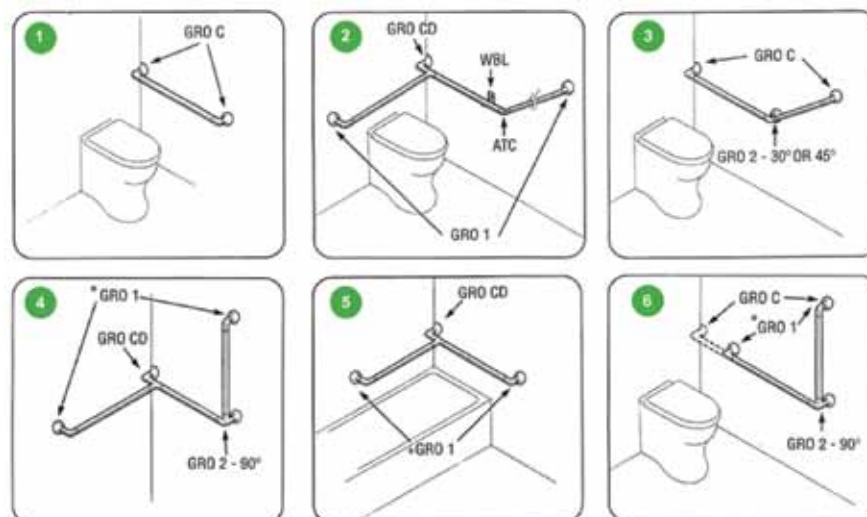

DVA CONTRACTED (all codes)

AL09 BUY (P.A Rqd)
Prescribers... OT/S/LMO

For approval rules refer to pg 7.

Ordering Example

To order configuration 4

- 1 x BTR101720 (Rail Elbow & Wall Flange)
- 1 x BTR101770 (One T-piece, one wall flange with washer & screw)
- 1 x BTR101880 (Internal Corner fitting, one corner wall flange)
- 3 x BTR101850 (900 mm Grab Rail complete with Multi Point End Set)

Item No.	Part	Description
Tubes		
BTR101805	GR03	Rail 300mm Tube 32mm diameter
BTR101820	GR04.5	Rail 450mm Tube 32mm diameter
BTR101840	GR06	Rail 600mm Tube 32mm diameter
BTR101850	GR09	Rail 900mm Tube 32mm diameter
BTR101740	GR012	Rail 1200mm Tube 32mm diameter
BTR101750	GR015	Rail 1500mm Tube 32mm diameter
Bends & Elbows		
BTR101780	GR02/30	One 30 deg bend, one wall flange with fixings
BTR101790	GR02/45	One 45 deg bend, one wall flange with fixings
BTR101800	GR02/90	One 90 deg bend, one wall flange with fixings
BTR101965	E30 & WBL	30 degree bend with WBL
BTR101966	E45 & WBL	45 degree bend with WBL
BTR101967	E90	90 degree tube connector not elbow
BTR101964	PB	Pipe Bend
BTR101870	GR0C2	Rail Elbow & Crn Flange 2Pk
BTR101860	GR0C	Rail Elbow & Std Flange Cnr Flange
BTR101720	GR01	Rail Elbow & Wall Flange
BTR101760	GR01SL	Two elbows. two slimline flanges with fixings

Item No.	Part	Description
Fixing		
BTR101810	GR03W	3 way fitting, wall flange includes fixings
BTR101830	GR04W	4 way fitting, wall flange includes fixings
BTR101890	GT	Gravity toggles Large or small with centreing sleeve
Fittings		
BTR101770	GR02	One T-piece, one wall flange with washer & screw
BTR101880	GR0CD	Internal Corner fitting, one corner wall flange
Accessories		
BTR101884	PEB	50mm diam. end ball for stop ending handrails
BTR101959	MP900	900mm Grab Rail complete with Multi Point End Set
BTR101963	CR	Connector Ring
BTR101961	ER	End Ring
BTR101882	HH	Handset and Hose
BTR101962	LER	Large End Ring
BTR101968	LAR	Lift Away Rail
BTR101969	LAR & SL	Lift Away Rail with Support Leg
BTR101420	ATC&WBL	Multi angle fittings for tubes
BTR101960	MP	Multi Point End Set
BTR101883	PE	Plug for End of Tube
BTR102930	SS	Rail Shower Slide
BTR101881	TRH	Toilet Roll Holder with fixing for grabrail or wall
BTR102200	TC	Tube Connector



Grab Rails

- This high quality stainless steel grab rail range is available in a number of different sizes from 300 mm length through to 1200 mm to provide security and safety in the bathroom, on steps or any area where support is required. Designed with a 32 mm diameter for a comfortable grip, these grab rails are available in either an Anti-Slip or white powdercoated finish. They also feature concealed fixings.

Note: check suitability for fit. Recommended to be installed by an authorised service person.

✓ DVA CONTRACTED
AL09 BUY (PA Rqd)
Prescribers... OT/S/LMO
For approval rules refer to pg 7.

 Aidacare Home
Modification Services

Code	Description	Length	Diameter	Warranty	✓ RAP #:
BTR102140	Grab Rail Anti Slip S.S. 300	300 mm	32 mm	12 months	AL09
BTR102160	Grab Rail Anti Slip S.S. 450	450 mm	32 mm	12 months	AL09
BTR102170	Grab Rail Anti Slip S.S. 600	600 mm	32 mm	12 months	AL09
BTR102175	Grab Rail Anti Slip S.S. 750	750 mm	32 mm	12 months	AL09
BTR102180	Grab Rail Anti Slip S.S. 900	900 mm	32 mm	12 months	AL09
BTR102185	Grab Rail Anti Slip S.S. 1200	1200 mm	32 mm	12 months	AL09
BTR102190	Grab Rail White Ripple S.S. 300	300 mm	32 mm	12 months	AL09
BTR102191	Grab Rail White Ripple S.S. 450	450 mm	32 mm	12 months	AL09
BTR102192	Grab Rail White Ripple S.S. 600	600 mm	32 mm	12 months	AL09
BTR102194	Grab Rail White Ripple S.S. 900	900 mm	32 mm	12 months	AL09



Suction Grab Rails

- This range of suction grab rails are lightweight and portable, featuring a durable commercial grade suction cup making them the strongest in the market. Easy to instal and removes with out any tools, the suction grab rails come in a range of standard, telescoping and pivot grip.

Note: check suitability of surface before use. Not suitable for all surfaces.

✓ DVA CONTRACTED
AL09 BUY (PA Rqd)
Prescribers... OT/S/LMO
For approval rules refer to pg 7.

Code	Description	Length	Warranty	✓ RAP #:
BTR102201	Suction Grab Rail	330 mm	12 months	AL09
BTR102202	Suction Grab Rail Medium Telescoping	480 - 610 mm	12 months	AL09
BTR102203	Suction Grab Rail Large Telescoping	610 - 735 mm	12 months	AL09



Speciality Toilet Rails

- This range of Specialty Toilet Rails has a number of various configurations of rail length and mountings to suit the requirements of each toilet configuration. These high quality stainless steel rails are manufactured from 32 mm diameter 1.2 mm guage heavy grade T304 polish tube. Flanges are five holed (75 mm dia x 2.5 mm thick) and are fully welded on the underside of the flange, forming an extremely strong, clean and hygenic product. Standard wall clearance is 60 mm ensuring compliance with AS1428.1:2001. All rails are manufactured with an electro polished finish as standard. Alternatively you can request a satin or epoxy coated finish depending on your decor requirements - specify at time of order.

✓ DVA CONTRACTED
AL09 BUY (PA Rqd)
Prescribers... OT/S/LMO
For approval rules refer to pg 7.

 Aidacare Home
Modification Services

Code	Description	Length	Warranty	✓ RAP #:
BTR101925	Grab Rail Type 05 Left Hand 45 deg Bend	600 mm sections	12 months	AL09
BTR101926	Grab Rail Type 05 Right Hand 45 deg Bend	600 mm sections	12 months	AL09
BTR101930	Grab Rail Type 06 Right Hand 45 deg Bend	1400 mm sections	12 months	AL09

Aidacare Online

For all of your product enquiries in one user-friendly site visit us online at www.aidacare.com.au

- New product releases - updated daily
- Clear and concise product descriptions and specifications
- Contract specific ordering information (DVA, TAC & MASS)
- Downloadable DVA RAP and other order forms
- Full colour product images
- Information on our range of service offerings
- Newsletter subscription page

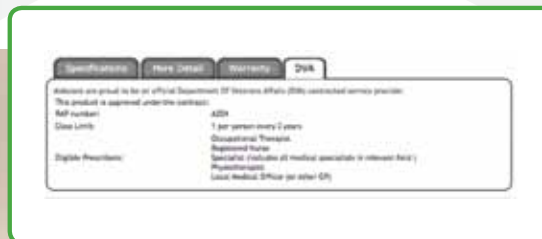

"We care for your care"



Bedroom



- P 065 Folding Beds & Accessories
- P 066 Facility / Hospital Beds & Accessories
- P 071 Bed Sticks / Bed Poles & Other Accessories
- P 074 Overbed Tables
- P 075 Pillows & Supports
- P 078 Mattress Overview
- P 087 Bedside Cabinets
- P 088 Bedside Commodes
- P 090 Falls Prevention & Alarms



Community Care Bed

- A simple yet stylish design, the Community Bed is an electronically controlled bed for aged care or home Environments.
- Made of solid construction for strength, safety and stability, the Community Bed enables both care giver and patient to reposition the bed for most aspects of care
- The extensive lifting range and bed base functionality make getting in and out of bed easy, helping to increase user independence whilst ensuring optimal conditions for the caregiver
- Standard features, such as the Support Pole for patient lifting assistance, plus a range of other optional accessories further simplify day to day living and care

✓ DVA CONTRACTED
AB01..... HIRE (P.A Rqd)
 Prescribers... OT/RN/Phys/ LMO/S/Ch/Ost
For approval rules refer to pg 7.

- Easy assembly, handling and storage
- Lockable castors

CONFIGURATIONS:

4 Function - Electric high/low, backrest, knee bend, trendelenberg & Reverse trendelenburg



Community Care Bed Accessories



Collapsible Side Rails



Patient IV Pole



Support Rails



Transport Brackets



Code	Description	External Len.	External Wid.	Bed Ht. Range	Mattress Dimensions	Safe Working Load	✓ RAP #:
BEB045650	Community Care Bed - 4 Function	220 mm	930 mm	340 - 750 mm	2000 x 850 mm	120 kg	AB01



Etude Duo Folding Bed

- Stylish modular design folding bed convenient for transportation or storage and ideal for the home care market
- Electric trendelenburg tilt for drainage and positioning of up to 11 degrees
- 100 mm twin castors act as trolley wheels when folded for easy transportation

Recommended mattresses: Lifecomfort long, Lifecomfort deluxe long or Lifecomfort pressure reducing long

✓ DVA CONTRACTED
AB01..... HIRE (P.A Rqd)
 Prescribers... OT/RN/Phys/ LMO/S/Ch/Ost
For approval rules refer to pg 7.

Note: Pictured with optional wooden side rails (BEA017700)

CONFIGURATIONS:

4 Function - Electric high/low, backrest, knee bend and trendelenburg

Code	Description	External Len.	External Wid.	Bed Ht. Range	Mattress Dimensions	Safe Working Load	✓ RAP #:
BEB045360	Etude Duo Scan Bed - 4 Function	2310 mm	904 mm	400 - 800 mm	850 x 2000 mm	180 kg	AB01

Etude Duo Bed Accessories



Code	Description	✓ RAP #:
BEA017400	Base Extension 100 mm	AB16
BEA017500	Base Extension 200 mm	AB16
BEA017600	Safety Sides Metal Folding- Grey	AB09
BEA017700	Safety Side Rails - Wooden	AB09
BEA017900	Self Help Pole	AB12
BEA017200	Bed Support Handle - Etude Duo - Large 40 x 30cm	AB16
BEA017350	Bed Transport Set - Basic Transport	-
BEA017100	Bed Support Handle - Small 25 x 30cm	-
BEA017300	Transport Kit	-

✓ DVA CONTRACTED
AB16.....BUY (P.A Rqd)
 Prescribers..OT/Phys/RN/LMO/S/Ch/Ost/POD
AB09.....BUY
 Prescribers..OT/RN/Phys/ LMO/S/Ch/Ost
AB12.....HIRE
 Prescribers..OT/RN/Phys/ LMO/S/Ch/Ost
For approval rules refer to pg 7.





Aidacare Bed

- Electric lifting and reclining bed for aged care, facility or home
- Australian made
- Removable head and foot panels
- Rounded corners minimise wall damage & maximise OH&S is safety
- Sheet steel bed platform sections
- 100 mm twin castors, optional central locking (CL) 125 mm twin castors available
- Recommended mattresses: Lifecomfort, Lifecomfort deluxe or Lifecomfort pressure reducing
- Nurse lockout on hand control
- 10 years warranty on structural frame
- 5 years warranty on electronics



CONFIGURATIONS:

- 2 Function - Electric high/low and backrest
- 3 Function - Electric high/low, backrest and knee bend



Code	Description	External Length	External Width	Bed Height	Mattress Dimensions	Safe Working Load
BEB045050	Aidacare Bed - 3 Function	1990 mm	920 mm	200 - 750 mm	1940 x 900 mm	200 kg
BEB045060	Aidacare Bed - 2 Function	1990 mm	920 mm	200 - 750 mm	1940 x 900 mm	200 kg
BEB045065	Aidacare & CL Castors - 3 Function	1990 mm	920 mm	200 - 750 mm	1940 x 900 mm	200 kg
BEA016493	Central Locking 125mm Twin Castor Wheels					

AIDACARE BED ACCESSORIES

BEA016495	IV Pole
BEA016500	Self Help Pole
BEA016530	Battery Back Up
BEA016520	Underbed Lighting
BEA016540	Base Extension 250mm
BEA016550	Wall Buffers - (Set of 4)
BEA016570	Bed Head/Footboard - Woodgrain Laminate



Unique Senatra Acute Care Bed

- State of the art hospital bed
- Made in Australia
- Two personal hand controls with one patient lock - out magnetic swipe key
- High quality Dewert electronics and battery back up
- CPR emergency button
- Single action central locking (CL) 125 mm castors and wall buffers to minimise wall damage
- Pull out extension
- Self help pole
- Adjustable IV pole and holder under bed for convenient storage
- Folding and removable side rails

CONFIGURATIONS:

- 4 Function - Electric high/low, backrest, knee bend and trendelenberg



Code	Description	External Length	External Width	Bed Height Range	Mattress Dimensions	Safe Working Load
BEB041200	Senatra Acute Care Bed - 4 Function	2030 mm	920 mm	190 - 750 mm	1940 x 900 mm	250 kg



Unique King Single Bed

- Bariatric 2 or 3 function electric lifting and reclining bed for aged care, hospital or home
- Safe working load of 350 kg
- Extra durable actuators provide added strength and stability
- Removable and reversible head and foot panels
- Rounded corners and bed buffers minimise wall damage
- Sheet steel mattress platform surface of 1050 x 2030 mm to accommodate large users
- 100 mm twin castors



✓ DVA CONTRACTED
AB01..... HIRE (P.A Rqd)
 Prescribers... OT/RN/Phys/ LMO/S/Ch/Ost
 For approval rules refer to pg 7.

CONFIGURATIONS:

- 2 Function - Electric high/low and backrest
- 3 Function - Electric high/low, backrest and knee bend
- 4 Function - Electric high/low, backrest, knee bend and trendelenberg

Recommended mattresses: Lifecomfort Pressure Reducing King Single Mattress (BEM046660) or Bariatric Mattress (BEM046700)

Code	Description	External Length	External Width	Bed Height Range	Mattress Dimensions	Safe Working Load	RAP #:
BEB045085	Unique - King Single - 4 Function	2120 mm	1050 mm	200 - 750 mm	2030 x 1050 mm	350 kg	-
BEB045070	Unique Bariatric King Single - 2 Fcn.	2120 mm	1070 mm	200 - 750 mm	2030 x 1050 mm	350 kg	-
BEB045080	Unique Bariatric King Single - 3 Fcn.	2120 mm	1070 mm	200 - 750 mm	2030 x 1050 mm	350 kg	AB01
BEB045090	Unique Double Bed - 2 Function	2120 mm	1370 mm	200 - 750 mm	2030 x 1370 mm	350 kg	-
BEB045100	Unique Double Bed - 3 Function	2120 mm	1370 mm	200 - 750 mm	2030 x 1370 mm	350 kg	-
BEB045110	Unique Queen Bed - 2 Function	2120 mm	1520 mm	200 - 750 mm	2030 x 1520 mm	350 kg	-
BEB045120	Unique Queen Bed - 3 Function	2120 mm	1520 mm	200 - 750 mm	2030 x 1520 mm	350 kg	-
BEB045122	Unique King Bed - 2 Function	2120 mm	1830 mm	200 - 750 mm	2030 x 1830 mm	350 kg	-
BEB045124	Unique King Bed - 3 Function	2120 mm	1830 mm	200 - 750 mm	2030 x 1830 mm	350 kg	-

Unique Bed Accessories

Code	Description	RAP #:	Code	Description
BEA016493	Central Locking 125mm Twin Castor Wheels	AB16	BEA016520	Underbed Lighting
BEA016495	IV Pole	AB16	BEA016540	Base Extension 250 mm
BEA016500	Self Help Pole	AB12	BEA016550	Wall Buffers - (Set of 4)
BEA016530	Battery Back Up	AB16	BEA016570	Bed Head/Footboard - Woodgrain Laminate
BEA005800	Safety Sides Rails	AB09	BEA009310	Bed Pole Clamp On - Left
BEA009300	Bed Pole Clamp On - Right	AB08		



Unique Floorline Bed Folding

- Folding Floor bed lowers to within 50mm of the floor for safety and access and folds for transportation or storage
- Fully height adjustable with trendelenburg tilt for drainage and positioning
- Bed ends will not raise and become obtrusive with bed height adjustment
- Wrap around mattress platform for infection control
- Removable head and footboards
- 100mm twin castors act as trolley wheels when folded for easy transportation
- Standard single bed or king single bed available

✓ DVA CONTRACTED
AB01..... HIRE (P.A Rqd)
 Prescribers... OT/RN/Phys/ LMO/S/Ch/Ost
 For approval rules refer to pg 7.

CONFIGURATIONS:

- 4 Function - Electric high/low, backrest, knee bend and trendelenberg

Code	Description	External Length	External Width	Bed Height Range	Mattress Dimensions	Safe Working Load	RAP #:
BEB045152	Unique F/line Bed Folding - 4 Fcn.	2140 mm	820 mm	50 - 750 mm	820 x 1920 mm	300 kg	AB01
BEB045158	Unique F/line Bed Folding King Single - 4 Fcn.	2270 mm	1050 mm	50 - 750 mm	1050 x 2030 mm	300 kg	-



Unique Floorline Bed

- Floor bed lowers to within 50 mm of the floor for safety and access in aged care
- Fully height adjustable with trendelenburg tilt for drainage and positioning
- Wrap around mattress platform for infection control
- Removable head and footboards
- 100 mm twin castors
- Standard single bed or king single bed available

- Optional built-in touch control pad for operating the bed mounts on the bed end column

CONFIGURATIONS:

3 Function - Electric high/low, backrest and trendelenburg

4 Function - Electric high/low, backrest, knee bend and Trendelenburg

Recommended mattresses: Lifecomfort regular, Lifecomfort deluxe regular or Lifecomfort pressure reducing regular

Code	Description	External Length	External Width	Bed Height Range	Mattress Dimensions	Safe Working Load
BEB045140	Unique Floorline Bed - 3 Function	2140 mm	820 mm	50 - 750 mm	1920 x 820 mm	300 kg
BEB045150	Unique Floorline Bed - 4 Function	2140 mm	820 mm	50 - 750 mm	1920 x 820 mm	300 kg
BEB045155	Unique Floorline Bed King Single - 3 Function	2270 mm	1050 mm	50 - 750 mm	2030 x 1050 mm	300 kg
BEB045157	Unique Floorline Bed King Single - 4 Function	2270 mm	1050 mm	50 - 750 mm	2030 x 1050 mm	300 kg

UNIQUE FLOORLINE BED ACCESSORIES

BEA016502	Bed Pole - Unique Beds - Double Clamp On
BEA016581	Bed Side Rails - Unique - Floor Full Length



Capri Floorline

The Capri offers the user and carer an easy to install and transportable floor line bed which is ideal for use in most nursing environments.

Standard Features

- Integrated bed extension
- Lock out handset
- Battery backup
- Complete trendelenburg functions

CONFIGURATIONS:

4 Function - Electric high/low, backrest, knee bend and trendelenburg

Recommended mattresses: Lifecomfort regular, Lifecomfort deluxe regular or Lifecomfort pressure reducing regular



Minimum height 130mm



Backrest, Knee break, Calf support



Backrest, Knee break



Trendelenburg



Folding

Code	Description	External Length	External Width	Bed Height Range	Mattress Dimensions	Safe Working Load	Supplier Code
BEB045330	Capri Bed - 4 Function	2470 mm	870 mm	130 - 725 mm	2000 x 850 mm	225 kg	MC300T4AW

REFER TO PG 78 FOR OUR RANGE OF MATTRESSES



Vienna Bed

- 3 function electric lifting and reclining bed for aged care, hospital or home
- 225 mm pull out bed extension
- Plastic moulded undercarriage
- Removable head and foot panels
- Sheet steel bed platform sections
- Bed buffers minimise wall damage
- Carer controlled lock out handset
- 125 mm total locking castors, optional central locking (CL) castors available

CONFIGURATIONS:

3 Function - Electric high/low, backrest and knee bend

Recommended mattresses: Lifecomfort long, Lifecomfort deluxe long or Lifecomfort pressure reducing long

Note: Pictured with optional safety side rails (BEA017000)

REFER TO PG 65 FOR
OUR FULL RANGE
OF GENERAL BED
ACCESSORIES



Bed Extension



Floor Level



Backrest & Knee Bend



Backrest & KneeBend

Code	Description	External Length	External Width	Bed Height Range	Mattress Dimensions	Safe Working Load	Supplier Code
BEB045320	Vienna Bed - 3 Function	2100 mm	870 mm	265 - 650 mm	2000 x 850 mm	225 kg	MC100T5AW
BEB045325	Vienna Bed - 3 Function & C.L.	2100 mm	870 mm	265 - 650 mm	2000 x 850 mm	225 kg	MC100C5AW



Milan Bed

- Quality electronics, motors and actuators for maximum reliability and performance
- Foot operated central locking system with stylised plastic moulded 5" castors
- Swipe card security system to immobilise the controls if required
- Excellent clearance underneath the bed for hoist access and safety bar to prevent damaging the control unit

- Lightweight removable ABS head and footboards with size and wood veneer options
- Ventilated clip on/off mattress panels for cleaning and maintenance purposes
- Protective devices at both ends of the bed to protect the walls and doors
- Easily operated bed extension (2385 mm extended)
- Backrest 0 to 80 degrees
- Knee break 0 to 45 degrees with a further manual adjustment option
- 10 year warranty on the bed frame and a 2 year warranty on the electrical equipment and castors
- 125 mm total locking castors, optional central locking (CL) castors available

CONFIGURATIONS:

2 Function - Electric high/low and backrest



Code	Description	External Length	External Width	Bed Height Range	Mattress Dimensions	Safe Working Load	Supplier Code
BEB045315	Milan Bed - 2 Function	2100 mm	870 mm	265 - 650 mm	2000 x 850 mm	225 kg	MC200T5AW
BEB045316	Milan Bed - 2 Function w/ C.L. Castors	2100 mm	870 mm	265 - 650 mm	2000 x 850 mm	225 kg	MC200C5AW

Vienna & Milan Bed Accessories

Code	Description
BEA016895	IV Pole
BEA016900	Self Help Pole
BEA017000	Safety Side Rails

Code	Description
BEA017001	Bed Side Rails - Folding Vertical - A/White
BEA017015	Bed Central Lock System - 4" castors
BEA017016	Bed Central Lock System - 5" castors
BEA017010	Bed Footboard - Small - A/White



Croft

CareWell Bed

- X lift design: reduces bed footprint
- Huge height range 210 mm to 760 mm, making patient moving easier for patients and for carers
- Telescopic leg extension, up to 2300 mm
- High 160 mm clearance, designed to be used with all lifters available in Australia
- Large safe working load up to 200 kg
- Electric knee break
- Battery backup reset function
- Easier maintenance with removable infection panels

- Head tilt panel and fowler backrest
- Flexible range of colours for head and footboard
- 10 year warranty on frame, 3 years on electronics
- Wood Grain Head and foot board
- Nurse Lockout

CONFIGURATIONS:

- 2 Function - Electric high/low and backrest
- 3 Function - Electric high/low, backrest and knee bend



Oden



Freya



Nimir King Single

Code	Description	External Width	External Length	Bed Height Range	Mattress Dimensions	Safe Working Load
BEB045800	CareWell Croft 2 Function	910 mm	2300 mm	210 - 760 mm	1950 - 2350 x 910 mm	200 kg
BEB045810	Carewell Oden 3 Function w/ C.L. castors	910 mm	2300 mm	210 - 760 mm	1950 - 2350 x 910 mm	200 kg
BEB045802	CareWell Croft 2 Function w/ C.L. castors	910 mm	2300 mm	210 - 760 mm	1950 - 2350 x 910 mm	200 kg
BEB045820	Carewell Freya - w/ Knee & Head Bend - CL Castors & Wooden Frame - 2 Function	910 mm	2300 mm	210 - 760 mm	1950 - 2350 x 910 mm	200 kg
BEB045825	CareWell Bed Nimir King Single 215 - 2 Function	1060 mm	1960 - 2260 mm	210 - 760 mm	1950 - 2350 x 1060 mm	215kg
GSP	CareWell Bed Nimir King Single 350	1060 mm	1960 - 2260 mm	210 - 760 mm	1950 - 2350 x 1060 mm	350kg

Carewell Bed Accessories

Code	Description
BEA026920	Self Help Pole
BEA026925	Satellite Arm Holder for remote
BEA026930	Bed Underbed lighting
BEA026935	Bedside Cabinet, three draw, castors, one lockable
BEA026915	Safety Side Rails
BEA026982	Bed IV Pole - IV Pole Telescopic Stainless Steel
BEA026983	Bed IV Pole - IV Pole Telescopic Epoxy 4 Hook
BEA026984	Bed Basket - Cloth Basket under bed
BEA026985	Oxygen Cylinder Holder Horizontal

REFER TO PAGE 78 FOR OUR
RANGE OF MATTRESSES



Bedroom



Self Help Pole Free Standing

- Free standing Self Help Pole assists user in sitting or repositioning in bed
- Sits behind or beside the bed
- Handle attached to chain or strap and is height adjustable
- Dismantles for storage or transportation
- Powder coated mild steel frame construction

✓ DVA CONTRACTED

AB12..... HIRE Prescribers..... OT/RN/Phys/ LMO/S/Ch/Ost	AB16..... BUY Prescribers..... OT/Phys/RN/LMO/S/Ch/Ost/POD
--	--

For approval rules refer to pg 7.

Code	Description	Product Weight	Max. User Weight	Supp. Code	RAP #:
BEA013100	Self Help Pole Free Standing	7 kg (base) 6 kg (upright)	120 kg	KA510	AB12
BEA013400	Bed Self Help Pole Handle			KA51H	AB16



Bed Rail

- Provides a support rail on the side of the bed
- Easily fits under mattress providing assistance for the user to reposition or transfer in and out of bed
- Easily installed and removed
- Powder coated mild steel construction
- Warranty: 12 months

✓ DVA CONTRACTED

AB09..... BUY
Prescribers... OT/RN/Phys/ LMO/S/Ch/Ost

For approval rules refer to pg 7.

Code	Description	Rail Width	Supp. Code	RAP #:
BEA013600	Bed Rail	600 mm	KA520	AB09



Bed Rail Drop Down

- Provides a support rail on the side of the bed
- Can be locked in the up or down position when required
- Easily fits under mattress providing assistance for the user to reposition or transfer in and out of bed
- Easily installed and removed
- Powder coated mild steel construction

✓ DVA CONTRACTED

AB09..... BUY
Prescribers... OT/RN/Phys/ LMO/S/Ch/Ost

For approval rules refer to pg 7.

Code	Description	Rail Width	Product Weight	Supp. Code	RAP #:
BEA013700	Bed Rail Drop Down	900 mm	5 kg	KA522	AB09

• Warranty: 12 months

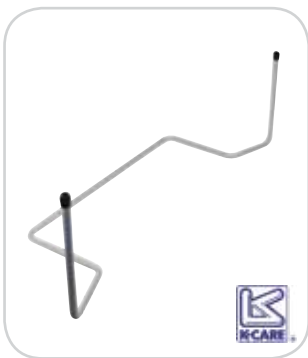

Bed Pole Dual Prong

- Provides a dual support pole on both sides of the bed
- Easily fits under mattress providing assistance for the user to reposition or transfer in and out of bed
- Powder coated mild steel construction
- Double or single bed size available
- Warranty: 12 months

✓ DVA CONTRACTED

AB08..... BUY
Prescribers... OT/RN/Phys/ LMO/S/Ch/Ost

For approval rules refer to pg 7.

Code	Description	Supplier Code	RAP #:
BEA013800	Bed Pole Dual Prong for Single Bed	KA524	AB08
BEA013900	Bed Pole Dual Prong for Double Bed	KA524D	AB08



Bed Pole Single Cobra

- Provides a support pole at the side of the bed
- Easily fits under mattress providing assistance for the user to reposition or transfer in and out of bed
- Position on either side of the bed
- Two poles may be positioned on the same bed
- Powder coated mild steel construction

✓ DVA CONTRACTED

AB08..... BUY
Prescribers... OT/RN/Phys/ LMO/S/Ch/Ost

For approval rules refer to pg 7.

Code	Description	Rail Height	Supplier Code	RAP #:
BEA014000	Bed Pole Single Cobra	510 mm	KA525	AB08



Bed Pole Single King Cobra

- Provides a taller support pole at the side of the bed
- Higher pole height of 650mm and a larger base section for extra stability
- Easily fits under mattress providing assistance for the user to reposition or transfer in and out of bed
- Position on either side of the bed

✓ DVA CONTRACTED
 AB08..... BUY
 Prescribers... OT/RN/Phys/ LMO/S/Ch/Ost
 For approval rules refer to pg 7.

Code	Description	Rail Height	Supplier Code	RAP #:
BEA014100	Bed Pole Single King Cobra	650 mm	KA527	AB08

- Two poles may be positioned on the same bed
- Powder coated mild steel construction



Bed Pole Grip Handle

- Provides a support pole at the side of the bed
- Grip handle provides assistance for the user to reposition or transfer in and out of bed
- Handle can be located in four positions for user comfort
- Easily fits under mattress providing assistance for the user to reposition or transfer in and out of bed
- Position on either side of the bed

✓ DVA CONTRACTED
 AB08..... BUY
 Prescribers... OT/RN/Phys/ LMO/S/Ch/Ost
 For approval rules refer to pg 7.

Code	Description	Supplier Code	RAP #:
BEA014200	Bed Pole Grip Handle	KA526	AB08

- Two poles may be positioned on the same bed
- Powder coated mild steel construction

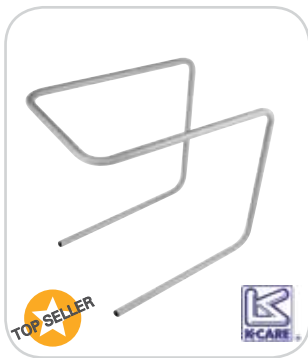

Bed Cradle

- Keeps bed linen off sensitive areas of the patient by creating clearance between bed linen and mattress
- Easily installed and removed
- Powder coated mild steel construction
- Warranty: 12 months

Note: Adjustable height model (BEA014600) also available but not pictured

✓ DVA CONTRACTED
 AB06..... BUY
 Prescribers... OT/Phys/RN/LMO/S/Ch/Ost/Pod
 For approval rules refer to pg 7.

Code	Description	Height	Supplier Code	RAP #:
BEA014400	Bed Cradle Epoxy Powder Coated	600 mm	KA540	AB06
BEA014500	Bed Cradle Stainless Steel	600 mm	KA540S	AB06
BEA014600	Bed Cradle Adj Height	480mm - 700mm	KA545	AB06



BEA014700

Adjustable Backrest Support

- Provides support and comfort when sitting upright in bed
- Support angle is easily adjusted
- Breathable nylon back
- Powder coated mild steel frame construction
- Warranty: 12 months

✓ DVA CONTRACTED
 AB02..... BUY
 Prescribers... OT/Phys/RN/LMO/S/Ch/Ost
 For approval rules refer to pg 7.

Code	Description	RAP #:
BEA014700	Bed Backrest - Adjustable Pillow Support	AB02
BEA009900	Bed Backrest - Adjustable Deluxe	AB02



Bed Blocks

- Plastic block raises the height of the bed or chair
- Suitable for use after knee or hip surgery when patients have trouble standing up from bed or chair
- Stackable and sold as each in two sizes

✓ DVA CONTRACTED
 AB03..... BUY
 Prescribers... OT/Phys/RN/LMO/S/Ch/Ost
 For approval rules refer to pg 7.

Code	Description	Height	RAP #:
BEA007400	Bed Blocks 40	40 mm	AB03
BEA007401	Bed Blocks 100	100 mm	AB03



Bed/Chair Raiser

- Raisers are placed on the floor under the legs of beds or lounge chairs to raise their height
- Ideal for those recovering from hip replacements, knee operations or as a result of ageing

DVA CONTRACTED
 AB03..... BUY
 Prescribers... OT/Phys/RN/LMO/S/Ch/Ost
 For approval rules refer to pg 7.

Code	Description	Height	RAP #:
BEA009700	Bed / Chair Raiser Blocks Wooden (Pkt 4)	75 mm	AB03
BEA009500	Bed / Chair Raiser Cones (Pkt 4)	90 mm	AB03
BEA009600	Bed / Chair Raiser Cones (Pkt 4)	140 mm	AB03



Bed Rail Protectors

- Placed over the bed rail for protection and support
- Provides padding and fills gaps in bed rails, reducing injury risk to patients from either hitting bed rails or getting limbs caught up
- Appropriate for static or collapsible bed rails, can still be lowered and raised
- Soft foam side rail cushions are covered with 2 way stretch PU covers

DVA CONTRACTED
 AB16.....BUY (P.A Rqd)
 Prescribers...OT/Phys/RN/LMO/S/Ch/Ost/POD
 For approval rules refer to pg 7.

Code	Description	Height	Length	RAP #:
BEA010775	Bed Rail Protectors	670 mm	1260 mm	AB16
BEA010776	Bed Rail Protectors Large	980 mm	1580 mm	-

- Easy to secure velcro attachment
- Sold as a pair



Post Operative Step

- Single and Double steps for bed access
- Single step - 240mm. Double step - 220mm and 400mm
- Black, non-slip ribbed rubber surface
- Rubber stoppers for stability
- Warranty: 12 months

Code	Description	Height	Supplier Code
BEA014900	Post Operative Step Single	240 mm	KH32SP
BEA014800	Post Operative Step Double	220 mm & 400 mm	KH32PD



Rope Ladder Tiger Tail

- Assists users to sit upright in bed
- Strong webbing construction
- Attaches to end of the bed

DVA CONTRACTED
 AB07..... BUY
 Prescribers... OT/Phys/RN/LMO/S/Ch/Ost
 For approval rules refer to pg 7.

Code	Description	RAP #:
BEA019400	Rope Ladder Tiger Tail	AB07
BEA010100	Rope Ladder	AB07



Overbed Table C Base

- Lightweight mobile table positions over bed or chair
- Can be used for eating, drawing or other activities
- Flat top ideal for hospital or home use
- Fully height adjustable
- "C" base shape fitted with four castors enables close positioning to the bedside or chair
- Powder coated mild steel frame construction
- Willuna white (beige) standard laminate top with vinyl wrap around the edge, or "thermoform" willuna white top which is heat resistant
- Beach colour laminate top is available as an option for (BEA006700) specify at time of order.

✓ DVA CONTRACTED
 AB13..... BUY
 Prescribers... OT/Phys/RN/LMO/S/Ch/Ost
 For approval rules refer to pg 7.

Code	Description	Top Length	Top Width	Height	✓ RAP #:
BEA006750	Overbed Table C Base with Thermoform Top	830 mm	410 mm	1050 mm - 710 mm	AB13
BEA006700	Overbed Table C Base with Laminate Top	830 mm	410 mm	1050 mm - 710 mm	AB13
BEA006650	Overbed Table C Base Economy	830 mm	410 mm	1050 mm - 710 mm	AB13



Overchair Table Four Post

- Lightweight mobile table positions over bed or chair
- Can be used for eating, drawing or other activities
- Angle adjustable with lipped edge to prevent items slipping off
- Four height adjustable legs able to support heavier objects
- "C" base shape fitted with four castors enables close positioning to the bedside or chair
- Stylish wood grain colour finish
- Powder coated mild steel frame construction

✓ DVA CONTRACTED
 AB13..... BUY
 Prescribers... OT/Phys/RN/LMO/S/Ch/Ost
 For approval rules refer to pg 7.

Code	Description	Length	Width	Height	Product Weight	Supplier Code	✓ RAP #:
BEA015400	Overchair Table Four Post	750 mm	440 mm	1000 mm - 600 mm	14 kg	KA572	AB13
BEA015500	Overchair Table Four Post Large	1000 mm	600 mm	1000 mm - 600 mm	20 kg	KA574	AB13



Overbed Table Split Tilt Top

- Lightweight mobile tilting table positions over bed or chair
- Can be used for eating, drawing or other activities
- Angle adjustable to 45 degrees, ideal for homecare environment
- Side table does not tilt, suitable for drink and food
- Fully height adjustable
- "C" base shape fitted with four castors enables close positioning to the bedside or chair
- Stylish cream colour finish
- Powder coated mild steel frame construction

✓ DVA CONTRACTED
 AB13..... BUY
 Prescribers... OT/Phys/RN/LMO/S/Ch/Ost
 For approval rules refer to pg 7.

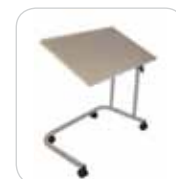

BEA15300



BEA006800

Code	Description	Length	Width	Height	Supplier Code	✓ RAP #:
BEA028100	Overbed Table Split Tilt Top C Base	855 mm	400 mm	710 - 1050 mm	KH161ET	AB13
BEA006800	Overbed Table Tilt Economy T Base	600 mm	510 mm	710 - 1170 mm		AB13
BEA015200	Overbed/Chair Table C Base Tilt Top Spring Loaded	745 mm	440 mm	710 - 970 mm	KA570SV	AB13
BEA015300	Overbed Table Tilt Dual	750 mm	440 mm	600 - 1000 mm	KA570V	AB13



Pillow Standard

- Siliconised polyester filled pillow is a great pillow for all environments
- 650gm weight
- Box of 15 available



Pillow Case - Protect A Plas

- PVC Protect A Plas is a waterproof soft two way stretch PVC pillow cover

Code	Description
BEP057700	Pillow Standard

Code	Description	Length	Width
BEP057400	PVC Pillowcase	750 mm	500 mm



Pillow Banana

- Therapeutic postural body pillow
- Super comfy and naturally shaped to support your whole body for bedtime reading or relaxing
- Helps maintain the spine's natural curvature



Pillow Sleepeasy

- Therapeutic postural pillow is customisable
- High or low, you create the pillow to suit your comfort and postural needs
- Long and short chambers provide for all physiques and sleeping positions
- Won't sag or lose shape

Code	Description
BEP051100	Pillow Banana (No Slip)
BEP051200	Pillow Banana Plain Slip Only
BEP051400	Pillow Banana Ruffled Slip Only

Code	Description	Length	Width	Height
BEP051500	Pillow Sleepeasy	560 mm	380 mm	120 mm



Pillow Sleepaway

- Smaller therapeutic postural pillow for users on the move
- Modified and miniaturised version of other therapeutic pillows
- Travellers can take this compact pillow similar to the one they use at home with them



Pillow Travellers

- Head and neck cushion
- Perfect for travellers or for resting upright in bed or while seated
- Promotes better posture while resting

Code	Description	Length	Width	Height
BEP051600	Pillow Sleepaway	390 mm	260 mm	100 mm
BEP051700	Pillow Sleepaway MF	390 mm	260 mm	100 mm
BEP051800	Pillow Sleepaway Slip Only			

Code	Description
BEP052000	Pillow Travellers Adult
BEP052100	Pillow Travellers Baby



Pillow Family

- Therapeutic postural pillow for the entire family
- Super soft eggfoam surface
- Gently contoured for user comfort and to encourage better posture



Pillow Tranquillow

- Gently contoured for user comfort and to encourage better posture
- Diffuses pressure points

Code	Description	Length	Width	Height
BEP052300	Pillow Family Low Profile	550 mm	380 mm	110 mm
BEP052400	Pillow Family Medium Profile	550 mm	380 mm	130 mm

Code	Description	Length	Width	Height
BEP053700	Pillow Tranquillow Soft	490 mm	400 mm	110 mm
BEP053500	Pillow Tranquillow Small Soft	490 mm	400 mm	110 mm
BEP053600	Pillow Tranquillow Standard Deluxe	490 mm	400 mm	130 mm
BEP053800	Pillow Tranquillow Standard SuperSoft	490 mm	400 mm	130 mm



Pillow Pyramid

- Therapeutic postural pillow embraces and supports the lower lumbar spine
- Provides full body support
- Ideal for those with medical conditions requiring an elevated sleeping position

Code	Description	Length	Width	Height
BEP054100	Pillow Pyramid with Ruffled Slip	800 mm	660 mm	140 mm
BEP054200	Pillow Pyramid with Tailored Slip			
BEP054300	Pillow Pyramid Ruffled Slip Only			
BEP054400	Pillow Pyramid Tailored Slip Only			



Pillow Pregnancy

- Inserted into bed to assist pregnant users body positioning
- Compact in size and is sculpted to "hug" the tummy

Code	Description
BEP054700	Pillow Pregnancy



Bed Wedge

- Inserted into bed to assist users body positioning and posture, angle at 14 degrees
- Ideal to aid those with asthma, bronchial or breathing constraints

DVA For eligibility & prescriber info please refer to pg 17.

Code	Description	Length	Width	Height	RAP #:
BEP054800	Bed Wedge with Quilted Slip	750 mm	680 mm	250 mm	AE02
BEP054900	Bed Wedge - Contoured Plain Slip - Cover Only				AE02
BEP055000	Bed Wedge with Waterproof Slip	750 mm	680 mm	250 mm	AE02
BEP055010	Bed Wedge Waterproof Slip Only				-
BEP056900	Bed Wedge - 65 x 65 x 20 cm - Cover				-



Pillow Complete Sleeprrr

- Two removable inserts allows user to change the shape for comfort and postural needs
- Gently contoured and ribbed for user comfort and to encourage better posture

Code	Description	Length	Width	Height
BEP055100	Pillow Complete Sleeprrr	520 mm	380 mm	105 mm
BEP055300	Pillow Complete Sleeprrr MF	520 mm	380 mm	105 mm
BEP055400	Pillow Complete Sleeprrr MF+	520 mm	380 mm	105 mm

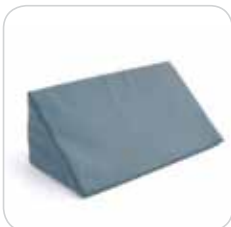

Positioning Body Wedge

- Inserted into bed to assist users body positioning and posture
- Pressure diffusing memory foam supports the front or back whilst lying

DVA For eligibility & prescriber info please refer to pg 17.

Code	Description	Length	Width	Height	RAP #:
BEP055905	Positioning Body Wedge	350 mm	170 mm	130 mm	AE02



Bed Seat

- Sculptured cushion prevents body slip while relaxing in bed
- Encourages better posture, relieves stress to the lower back and is beneficial to circulation

DVA For eligibility & prescriber info please refer to pg 17.

Code	Description	RAP #:
BEP055700	Bed Seat	AE02



Thigh Side Sleeper

- Rests between the thighs to promote correct bed position
- Helps maintain the spine's natural curvature and minimises twisting of the back during sleep
- Diffuses pressure and encourages circulation
- Useful as a post operative aid
- Memory Foam construction

DVA For eligibility & prescriber info please refer to pg 17.

Code	Description	RAP #:
BEP055900	Thigh Side Sleeper	AE02



Leg Spacer Memory Foam

- Rests between the knees to promote correct bed position
- Diffuses pressure and encourages circulation
- Helps align the spine and alleviate tension
- Memory Foam construction

Code	Description
BEP055901	Leg Spacer Memory Foam



Bedroom



Leg Relaxer

- Inserted into bed to assist users body positioning and posture
- Aids circulation in the lower limbs and provides even weight distribution alleviating lower back strain
- Ideal for those with varicose veins or swollen legs, and during pregnancy



Quad Cushion

- Inserted behind back, knees or ankles to assist users back positioning and posture
- Provides comfort and support for the lower back, under knees or under ankles by relieving pressure
- Ideal for those with lower back or knee pain or tension

DVA For eligibility & prescriber info please refer to pg 17.

Code	Description	Length	Width	Height	RAP #:
BEP056200	Leg Relaxer with Quilted Slip	710 mm	450 mm	200 mm	AE17
BEP056250	Leg Relaxer with Waterproof Slip	710 mm	450 mm	200 mm	AE17
BEP056260	Leg Relaxer Waterproof Slip Only				-
BEP056300	Leg Relaxer Plain Slip Only				-

DVA For eligibility & prescriber info please refer to pg 17.

Code	Description	Length	Width	Height	RAP #:
BEP056220	Quad Cushion	530 mm	260 mm	90 mm	AE02
BEP056221	Quad Cushion Replacement Slip Only				AE02



Pillow Naturelle

- Therapeutic postural pillow
- 100% pure latex construction provides wonderful comfort and support
- Gently contoured for user comfort and to encourage better posture
- Mould and dust free
- Won't sag or lose shape

Code	Description	Length	Width	Height
BEP056700	Pillow Naturelle Low	600 mm	390 mm	105 mm
BEP056600	Pillow Naturelle High	600 mm	390 mm	145 mm
BEP056800	Pillow Naturelle Medium	600 mm	390 mm	120 mm

REFER TO PAGE 78 FOR OUR RANGE OF MATTRESSES



Aidacare Mattresses Overview

Underlays & Overlays:

Pg

L Low Risk	• General Overlays	079
M Medium Risk	• Alternating Air - Aidacare 'Ultimate' Range	080
	• ROHO® Dry Flotation	081

Mattress Replacements:

Foam:

L Low Risk	• Lifecomfort	082
	• Lifecomfort with Safety Sides	082
	• Lifecomfort Deluxe	082
M Medium Risk	• Lifecomfort Pressure Reducing	083
	• Lifecomfort Bariatric	083
	• Lifecomfort with ROHO® Insert	083

Alternating Air / Low Air Loss:

H High Risk	• Ultimate Range	084
	• ROHO® Low Air Loss.....	085
V Very High Risk	• Theraflow	085
	• Sentech	085

Pressure Care Rating Indicator For Pressure Ulcer Risk Management

- L** Low Risk Patient
Comfort
- M** Medium Risk Patient
Prevention management
- H** High Risk Patient
Prevention and recuperation management
- V** Very High Risk Patient
Prevention and recuperation management





Bedroom



L

Pressure Surface Underlay

- Provides "bottoming out" protection for air alternating overlays and mattress replacements
- Minimal height addition to overall pressure care system
- Outer cover is fire retardant
- Antibacterial
- Vapour permeable (breathable)
- Water resistant

DVA CONTRACTED
 AB14.....BUY
 Prescribers..OT/Phys/RN/LMO/Pod/S/Ch/Ost
 For approval rules refer to pg 7.

- Complimentary product to be used with alternating pressure systems

Code	Description	Length	Width	Height	Max. User Wt.	RAP #:
BEM047050	Pressure Surface Underlay	1960 mm	865 mm	50 mm	130 kg	AB14



L

Mattress Overlay Naturelle Latex

- Anti-microbial and dust-mite resistant to alleviate allergies
- Hypoallergenic, hygienic, and antibacterial
- Optimal orthopaedic support (naturally conforming to body contours)
- Superior pressure relief that helps bring oxygen and nutrients to muscles

DVA CONTRACTED
 AB14.....BUY
 Prescribers..OT/Phys/RN/LMO/Pod/S/Ch/Ost
 For approval rules refer to pg 7.

Code	Description	Length	Width	Height	Max. User Wt.	RAP #:
BEM047181	M/ Overlay Naturelle Latex Single	1880 mm	905 mm	50 mm	100 kg	AB14
BEM047182	M/ Overlay Naturelle Latex Double	1880 mm	1355 mm	50 mm	100 kg	AB14
BEM047183	M/ Overlay Naturelle Latex Queen	2000 mm	1505 mm	50 mm	100 kg	AB14
BEM047184	M/ Overlay Naturelle Latex King	2000 mm	1805 mm	50 mm	100 kg	AB14



L

Mattress Overlay Spenco

- Silicone coated fibre filled overlay
- Cylindrical hollow core fibres provide greater comfort and shear reduction
- Quality breathable cotton cover
- Heavy duty stitching
- Supplied with heat sealed waterproof cover
- Machine washable

DVA CONTRACTED
 AB14.....BUY
 Prescribers..OT/Phys/RN/LMO/Pod/S/Ch/Ost
 For approval rules refer to pg 7.

Code	Description	Length	Width	Warranty	Max. User Wt.	RAP #:
PTM636160	Mattress Overlay Spenco	1980 mm	910 mm	12 months	100 kg	AB14



L

TOP SELLER

Mattress Overlay Silicone Fibre

- Fits under bed sheet to reduce friction and shear for the whole body
- Silicone coated cylindrical hollow core fibres construction
- Assists with geriatric and palliative care as silicone fibres do not absorb perspiration or urine
- Helps improve sleep by adding extra softness and support to the bed, even if lying in one position for extended periods

DVA CONTRACTED
 AB14.....BUY
 Prescribers..OT/Phys/RN/LMO/Pod/S/Ch/Ost
 For approval rules refer to pg 7.

Code	Description	Length	Width	Height	Max. User Wt.	RAP #:
PTM636170	Mattress Overlay Silicone Fibre	1900 mm	910 mm	100 mm	100 kg	AB14



L

Convolutated Overlay

- Fits under bed sheet to re-distribute pressure points for therapeutic pressure relief and comfort
- Improves air flow around the mattress helping to maintain a constant body temperature and improve sleep quality
- Egg shell shape/convoluted foam

DVA CONTRACTED
 AB14.....BUY
 Prescribers..OT/Phys/RN/LMO/Pod/S/Ch/Ost
 For approval rules refer to pg 7.

Code	Description	Length	Width	Height	Warranty	RAP #:
PTM636260	Convolutated Overlay Single	1880 mm	915 mm	50 mm	12 months	AB14
PTM636270	Convolutated Overlay Double	1880 mm	1370 mm	50 mm	12 months	AB14
PTM636280	Convolutated Overlay Queen	2030 mm	1520 mm	50 mm	12 months	AB14

L Low Risk M Medium Risk H High Risk V Very High Risk



ROHO® Mattress Section

- Dry flotation mattress system allows user to lie or sit comfortably for long periods
- Interconnected and flexible air cells provide protection and relief for user at risk of skin breakdown or already with early stage ulcers
- Adjustable air pressure to suit the user
- Flexibility provides effective friction and shear relief
- Drainage holes allow fluids to escape

✓ DVA CONTRACTED
 AB15..... HIRE (P.A Rqd)
 Prescribers... OT/Phys/RN/LMO/S
 For approval rules refer to pg 7.

Note: Bedsizes divided into 4 sections where ROHO Mattress Sections can be applied. 1, 2, 3 or 4 sections can be used in combination with foam sections where risk of pressure is not as critical

Code	Description	Length	Width	Height	Warranty	Max. User Wt.	RAP #:
PTM636335	ROHO DRY FLOATATION® Mattress Overlay (4 sections)	1960 mm	860 mm	80 mm	24 months	Unlimited	AB15
PTM636320	ROHO DRY FLOATATION® Mattress Section (1 section)	490 mm	860 mm	80 mm	24 months	Unlimited	AB15



ROHO® Levelling Pad

- High quality foam insert sections interconnect with ROHO Mattress Sections by clipping together
- Therapeutic foam, which is hypoallergenic, anti-microbial and anti-bacterial
- Waterproof, fitted, low friction nylon cover is also anti-microbial and anti-bacterial
- Cost effective use of foam and ROHO provides the ultimate in pressure care

✓ DVA CONTRACTED
 AB15..... HIRE (P.A Rqd)
 Prescribers..OT/Phys/RN/LMO/S
 AB14..... BUY
 Prescribers..OT/Phys/RN/LMO/Pod/S/Ch/Ost
 For approval rules refer to pg 7.

Code	Description	Length	Width	Height	Warranty	Max. User Weight	RAP #:
PTM636360	ROHO® Levelling Pad - Long	2032 mm	864 mm		12 months	Unlimited	AB15
PTM636220	ROHO® Levelling Pad - Short	508 mm	863 mm	80 mm	12 months	100 kg	AB14

**REFER TO WHEELCHAIR & SEATING
PAGE 356 FOR OUR FULL RANGE
OF ROHO PRESSURE CUSHIONS**



L Low Risk **M** Medium Risk **H** High Risk **V** Very High Risk



Ultimate 25

- A slimline mattress overlay comfort system for patients at lower risk of pressure ulcers
- Lightweight, portable system providing an air comfort factor instead of silicone or soft fibre
- Supports users to 100 kg
- Mattress overlay folds under the end of any standard single bed mattress
- Includes a repair kit for most patching repairs

✓ DVA CONTRACTED
AB14.....BUY
 Prescribers...OT/Phys/RN/LMO/Pod/S/Ch/Ost
 For approval rules refer to pg 7.

Code	Description	Length	Width	Height	Cycle Time	Warranty	Max. User Weight	✓ RAP #:
PTM636550	Ultimate 25	2380 mm	1030 mm	50 mm	8 - 10 mins	12 months	100 kg	AB14



Ultimate 75

- A mattress overlay support system for patients at medium risk of pressure ulcers
- An economic and comfortable solution to pressure injury prevention
- Lightweight, manoeuvrable, versatile and easy to place over any existing mattress
- Supports users to 120 kg
- End straps securely fasten the system to the mattress

✓ DVA CONTRACTED
AB14.....BUY
 Prescribers...OT/Phys/RN/LMO/Pod/S/Ch/Ost
 For approval rules refer to pg 7.

- Reduced cell depth allows independence via easy movement in and out of bed
- Whisper quiet operation and easy-to-use controls enable precise comfort adjustments
- Easy to assemble and operate for users and carers

Code	Description	Length	Width	Height	Cycle Time	Warranty	Max. User Weight	✓ RAP #:
PTM636560	Ultimate 75	2000 mm	880 mm	80 mm	8 - 10 mins	24 months	120 kg	AB14



Ultimate 125 Digital

- A mattress overlay support system for patients at medium risk of developing pressure ulcers
- Combines some of the best features of the Ultimate 225 in an Overlay System
- Prevention of Decubitus Ulcers is the core strategy of this product
- Used best in conjunction with an effective strategy for pressure injury prevention
- Lightweight, manoeuvrable, versatile and easy to place over any existing mattress
- Supports users to 150 kg

✓ DVA CONTRACTED
AB15.....HIRE (P.A Rqd)
 Prescribers... OT/Phys/RN/LMO/S
 For approval rules refer to pg 7.

- Appropriate for home care and nursing home settings
- Whisper quiet operation with a host of capabilities
- Digital control unit with audio alarm to alert carer to malfunction
- Static button to activate full inflation of all cells enabling ease of process when transferring and treating patients

Code	Description	Length	Width	Height	Cycle Time	Warranty	Max. User Weight	✓ RAP #:
PTM636530	Ultimate 125 Digital	2000 mm	880 mm	130 mm	12 mins	24 months	150 kg	AB15

L Low Risk **M** Medium Risk **H** High Risk **V** Very High Risk

DVA Contact Details
 P 1300 888 052
 F 1300 787 052
 E dva@aidacare.com.au

General Enquiries
 P 1300 133 120
 E admin@aidacare.com.au
 W www.aidacare.com.au





Lifecomfort

- Pressure care bed mattress
- Two layer foam support design for comfort and support
- Full size memory foam overlay
- Two way waterproof stretch cover
- Vinyl bottom cover
- Three sided zip for easy cover removal
- Stitched zipper cover with waterproof flap for excellent hygiene

✓ DVA CONTRACTED
 AB14.....BUY
 Prescribers..OT/Phys/RN/LMO/Pod/S/Ch/Ost
 For approval rules refer to pg 7.

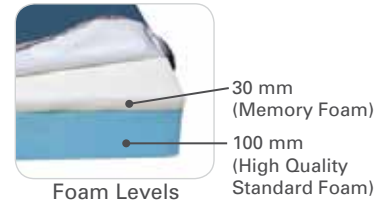

Code	Description	Length	Width	Height	Warranty	Max. User Weight	✓ RAP #:
BEM046400	Lifecomfort	1940 mm	900 mm	130 mm	12 months	100 kg	AB14
BEM046425	Lifecomfort Regular/Small	1920 mm	820 mm	130 mm	12 months	100 kg	AB14
BEM046450	Lifecomfort Long	2000 mm	850 mm	130 mm	12 months	100 kg	AB14



Lifecomfort with Safety Sides

- Pressure care bed mattress with sidewall support to help minimise user falls
- Two layer foam support design for comfort and support
- Full size memory foam overlay
- Two way waterproof stretch cover
- Vinyl bottom cover
- Three sided zip for easy cover removal
- Stitched zipper cover with waterproof flap for excellent hygiene

✓ DVA CONTRACTED
 AB14.....BUY
 Prescribers..OT/Phys/RN/LMO/Pod/S/Ch/Ost
 For approval rules refer to pg 7.

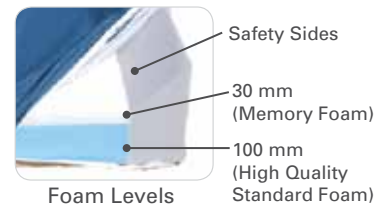

Code	Description	Length	Width	Height	Warranty	Max. User Weight	✓ RAP #:
BEM046475	Lifecomfort with Safety Sides	1940 mm	900 mm	130 mm	12 months	100 kg	AB14



Lifecomfort Deluxe

- Pressure care bed mattress
- Three layer foam support design for enhanced comfort and support
- Full size memory foam overlay
- Two way waterproof stretch cover
- Vinyl bottom cover
- Three sided zip for easy cover removal
- Stitched zipper cover with waterproof flap for excellent hygiene
- PUPPS 2 (2004) compliant

✓ DVA CONTRACTED
 AB14.....BUY
 Prescribers..OT/Phys/RN/LMO/Pod/S/Ch/Ost
 For approval rules refer to pg 7.

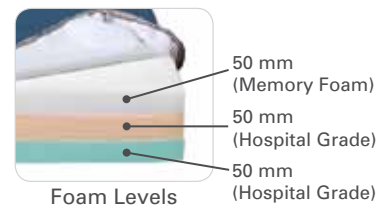

Code	Description	Length	Width	Height	Warranty	Max. User Weight	✓ RAP #:
BEM046500	Lifecomfort Deluxe	1940 mm	900 mm	150 mm	12 months	140 kg	AB14
BEM046525	Lifecomfort Deluxe Regular/Small	1920 mm	820 mm	150 mm	12 months	140 kg	AB14
BEM046550	Lifecomfort Deluxe Long	2000 mm	850 mm	150 mm	12 months	140 kg	AB14

L Low Risk **M** Medium Risk **H** High Risk **V** Very High Risk



Bedroom

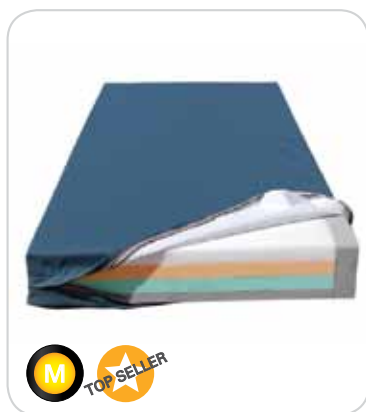

Lifecomfort Pressure Reducing

- Pressure reducing bed mattress
- Four layer foam support design for maximum comfort and support
- Full size memory foam overlay
- Foam side walls for extra stability on the edge of the mattress
- Two way waterproof stretch cover
- PVC bottom cover
- Three sided zip for easy cover removal
- Welded zipper cover with waterproof flap for the best hygiene
- PUPPS 2 (2004) compliant

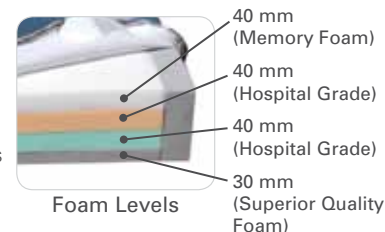

Code	Description	Length	Width	Height	Warranty	Max. User Weight
BEM046600	Lifecomfort Pressure Reducing	1940 mm	900 mm	150 mm	12 months	150 kg
BEM046625	Lifecomfort Pressure Reducing Regular/Small	1920 mm	820 mm	150 mm	12 months	150 kg
BEM046650	Lifecomfort Pressure Reducing Long	2000 mm	850 mm	150 mm	12 months	150 kg
BEM046660	Lifecomfort Pressure Reducing King Single	2030 mm	1050 mm	150 mm	12 months	150 kg
BEM046675	Lifecomfort Pressure Reducing Double	2030 mm	1370 mm	150 mm	12 months	150 kg
BEM046680	Lifecomfort Pressure Reducing Queen	2030 mm	1500 mm	150 mm	12 months	150 kg



Lifecomfort Bariatric

- Pressure reducing bariatric bed mattress
- Extra weight capacity up to 300 kg
- Three layer foam support 200 mm high for bariatric use with maximum comfort and support
- Full size memory foam overlay
- Foam side walls for extra stability on the edge of the mattress
- Two way waterproof stretch cover
- PVC bottom cover
- Four sided zip for easy cover removal
- Stitched zipper cover with waterproof flap for excellent hygiene
- Independently tested and certified for durability and weight rating
- PUPPS 2 (2004) compliant

DVA CONTRACTED

AB14.....BUY

Prescribers..OT/Phys/RN/LMO/Pod/S/Ch/Ost

For approval rules refer to pg 7.

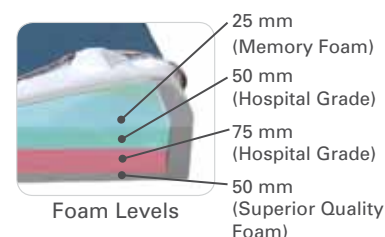

Code	Description	Length	Width	Height	Warranty	Max. User Weight	RAP #:
BEM046700	Lifecomfort Bariatric	2030 mm	1050 mm	200 mm	12 months	300 kg	AB14

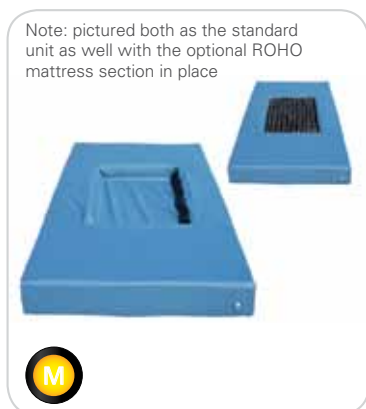

Lifecomfort Pressure Reducing with ROHO Insert Cut Out

- Bed mattress with ultimate pressure reduction solution
- Uses standard size ROHO mattress section (BEM636320) for additional pressure relief in the pelvic section of the mattress
- Support, comfort and pressure reduction all in one
- Four layer foam support design with side walls for extra stability
- Full size memory foam overlay
- Two way welded waterproof stretch cover
- Three sided zip for easy cover removal
- Welded zipper cover with waterproof flap for the best hygiene
- PUPPS 2 (2004) compliant

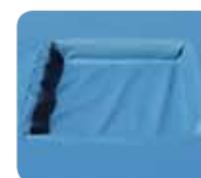

Code	Description	Length	Width	Height	Warranty	Max. User Weight
BEM046720	Lifecomfort Pressure Reducing with ROHO® Insert	1940 mm	900 mm	150 mm	12 months	150 kg

L Low Risk **M** Medium Risk **H** High Risk **V** Very High Risk

DVA Contact Details P 1300 888 052
F 1300 787 052
E dva@aidacare.com.au

General Enquiries P 1300 133 120
E admin@aidacare.com.au
W www.aidacare.com.au





Ultimate 200 Digital

- An economic, full mattress support system for patients at high risk of developing pressure ulcers
- Increased cell depth is ideal for the heavier patient, prevents "bottoming out" and enhances therapeutic comfort
- Heat sealed seams, antibacterial taping and waterfall skirts facilitate effective infection control and prevention
- Used best in conjunction with an effective strategy for pressure injury prevention

✓ DVA CONTRACTED
AB15..... HIRE (P.A Rqd)
 Prescribers... OT/Phys/RN/LMO/S
For approval rules refer to pg 7.

- Supports users to 180kg
- Whisper quiet operation with a host of capabilities
- Digital control unit with audio alarm to alert carer to malfunction
- Static button to activate full inflation of all cells for ease of process when transferring and treating patients
- Portable and manoeuvrable

Code	Description	Length	Width	Height	Cycle Time	Warranty	Max. User Weight	✓ RAP #:
PTM636540	Ultimate 200 Digital	2000 mm	880 mm	200 mm	8-10 mins	24 months	180 kg	AB15



Ultimate 225

- A professional, clinical care, full mattress support system for patients at very high risk of developing pressure ulcers
- Unique heel zone ensures pressure alternation of high risk areas of the lower leg
- Lateral side bolsters for additional patient stability
- Excellent healing surface for patients receiving treatment for existing wounds
- Pressure redistribution through cell-in-cell technology for ultimate patient support, treatment and comfort
- Supports users to 180kg

✓ DVA CONTRACTED
AB15..... HIRE (P.A Rqd)
 Prescribers... OT/Phys/RN/LMO/S
For approval rules refer to pg 7.

- Whisper quiet operation with a host of capabilities
- Digital control unit with audio alarm to alert carer to malfunction
- Static button to activate full inflation of all cells for ease of process when transferring and treating patients
- Portable and manoeuvrable

Code	Description	Length	Width	Height	Cycle Time	Warranty	Max. User Weight	✓ RAP #:
PTM636545	Ultimate 225 Digital	2000 mm	880 mm	203 mm	8-10 mins	24 months	180 kg	AB15



Concave Positioning Cover

- Positioning Cover assists in the prevention of users rolling against side rails or falling off the bed
- A valuable accessory to any of the Ultimate alternating mattress types
- Modular foam sections can be removed to enable patient transfer
- Support system also conforms to profiling beds with head raisers and knee breaks
- All components are heat sealed making it impermeable to fluids for maximum infection control
- Suits Ultimate 125 - 200

Code	Model	Length	Width	Height	Warranty
PTM636565	Concave Positioning Cover	2000 mm	880 mm	100 mm (outside)	24 months

L Low Risk **M** Medium Risk **H** High Risk **V** Very High Risk



ROHO® SelectAir Max

- A low air loss full mattress system for effective skin protection and pressure sore prevention
- Management of pressure, friction, shear and moisture is essential for skin care and pressure ulcer prevention
- The Low Air Loss technology “wicks” excessive moisture away via gentle air flow under a permeable cover
- Skin is maintained at a healthy moisture level without being damaged by drying out from direct air flow

✓ DVA CONTRACTED

AB15..... HIRE (P.A Rqd)

Prescribers... OT/Phys/RN/LMO/S

For approval rules refer to pg 7.

- An extremely comfortable, effective and gentle alternative for the high risk client
- Very quiet and reliable operation with low energy consumption
- Easy-to-use controls with firm mattress mode to facilitate nursing care and patient repositioning
- Portable and lightweight

Code	Description	Length	Width	Height	Warranty	Max. User Weight	✓ RAP #:
PTM636620	ROHO® SelectAir Max	2110 mm	860 mm	200 mm	12 months	180 kg	AB15



Theraflow

- Reperfusion Mattress Replacement Support System is a breakthrough in pressure release technology
- Australian patented system uses the energy in the mattress itself to alternately “pull” cells away from the patient
- It alternately removes almost all interface pressure under nearly 80% of the patient’s body
- The at-risk heel area is completely elevated for nearly 30% of the alternation cycle
- Unique design allows cell pairs to remain upright when normal cells deform or collapse under patient weight
- Infection control - outer surfaces fully welded - “mattress within a mattress” design ensures complete protection
- CellStay support coverlet provides unparalleled clinical effectiveness, infection control and comfort
- Customised sections can be engaged and disengaged to focus therapy on specific at-risk areas
- Supports users from 40kg to 200kg
- Very quiet and reliable air pump and control system with many features
- Two handles each side make it portable and manoeuvrable

Code	Description	Length	Width	Height	Cycle Time	Warranty	Max. User Weight
PTM636640	Theraflow	2000 mm	880 mm	245 mm	14 mins	24 months	200 kg



SenTech Stage IV 2000

- A combination of Alternating Pressure Relief and a True Low Air Loss technology full mattress support system
- Dynamic surface effectively addresses issues associated with Decubitis Ulcers and pressure care management
- True Low Air Loss constantly forces gentle streams of air through micropores, thus cooling and drying the body
- The alternation system ensures effective pressure redistribution
- Supports users to 230kg
- An intuitive, multi-purpose system, offering a quality solution to high-end home care or intensive clinical needs
- Very quiet and reliable air pump and control system with many features
- Portable and manoeuvrable

Code	Description	Length	Width	Height	Warranty	Max. User Weight
PTM636490	SenTech Stage IV 2000	2032 mm	915 mm	216 mm	24 months	230 kg

L Low Risk
 M Medium Risk
 H High Risk
 V Very High Risk

DVA Contact Details
 P 1300 888 052
 F 1300 787 052
 E dva@aidacare.com.au

General Enquiries
 P 1300 133 120
 E admin@aidacare.com.au
 W www.aidacare.com.au





SenTech Stage IV Millen 3

- A unique combination of True Low Air Loss and intensive Alternation full mattress system therapies
- 3-zone cell system facilitates pressure redistribution into individually controlled sections for head, torso and legs
- High-risk anatomical areas can be managed by varying pressure in contact cells to increase therapeutic benefits
- True Low Air Loss constantly forces gentle streams of air through micropores, thus cooling and drying the body
- Supports users to 230kg
- Mattress surface is ideal for patients receiving treatment for ulceration, burns, flaps and grafts
- Control unit is simple to set up and operate and can be customised for any user
- Control unit constantly monitors and adjusts intracellular pressures to maximise patient comfort
- Portable and manoeuvrable

Code	Description	Length	Width	Height	Warranty	Max. User Weight
PTM636500	SenTech Stage IV Millen 3 - 914	2032 mm	914 mm	203 mm	24 months	230 kg
PTM636505	SenTech Stage IV Millen 3 - 990	2032 mm	990 mm	203 mm	24 months	450 kg
PTM636506	SenTech Stage IV Millen 3 - 1219	2032 mm	1219 mm	203 mm	24 months	450 kg



SenTech Thera-Turn Millen

- A combination Lateral Rotation and controlled True Low Air Loss full mattress support system
- Designed to aid in the management of various respiratory complications, often used in intensive care units
- Performs Continuous Lateral Rotational Therapy advocated for critically ill patients with low mobility
- Can rotate a patient up to a 40 degree angle in each direction over an adjustable timeframe by alternating air cells
- Outer edge cells (bolsters) continuously remain inflated to help support and position the patient
- True Low Air Loss constantly forces gentle streams of air through micropores, thus cooling and drying the body
- Supports users to 230 kg or 340 kg in Bariatric
- Designed to accommodate a wide range of patient weights
- Microprocessor control unit constantly monitors and adjusts intracellular pressures to maximise patient positioning
- Portable and manoeuvrable

Code	Description	Length	Width	Height	Warranty	Max. User Weight
PTM636510	SenTech Thera-Turn Millen - 914	2032 mm	914 mm	305 mm	24 months	136 kg
PTM636515	SenTech Thera-Turn Millen 48" - 1213	2032 mm	1219 mm	305 mm	24 months	340 kg

REFER TO WHEELCHAIR & SEATING
PAGE 356 FOR OUR FULL RANGE OF
ROHO PRESSURE CUSHIONS





Bedroom



Bedside Cabinet with Hutch

- Bedside cabinet with convenient top hutch
- A number of drawer configurations available
- Optional accessories available: Split drawer, Lock
- Five colours available

Code	Description	Height	Width	Depth	Warranty
WAT758900	Bedside Cabinet with Hutch & 4 Drawers	1020 mm	460 mm	450 mm	60 months



Bedside Cabinet - 2 Drawers + 1 Dump Drawer (Various Colours)

- Bedside cabinet with two conventional drawers plus a dump drawer at the bottom
- Available with rail at the top
- Optional lock for top drawer
- Five colours available

Code	Description	Height	Width	Depth	Warranty
WAT761400	Bedside Cabinet 2 Drawers + 1 Dump Drawer	800 mm	460 mm	450 mm	60 months



Bedside Cabinet - 4 Drawers (Various Colours)

- Bedside cabinet with four conventional drawers
- Optional lock for top drawer
- Five colours available

Code	Description	Height	Width	Depth	Warranty
WAT761500	Bedside Cabinet with 4 Drawers	800 mm	460 mm	450 mm	60 months

NOTE: ALL BEDSIDE CABINETS CAN BE COLOUR CO-ORDINATED TO MATCH THE BEDROOM FURNITURE



Bedside Commode Economy

- Bedside chair can be used for toileting
- Comes with removable padded seat, lift up toilet seat flap, fixed bowl carrier and bowl
- Removable backrest for storage or transportation
- Fully height adjustable to suit user requirements
- Fitted with non-slip rubber tips
- Mild steel epoxy coated frame is phosphate treated for corrosion resistance

✓ DVA CONTRACTED

BE02..... BUY
Prescribers... OT/RN/CA/LMO
For approval rules refer to pg 7.

Code	Description	Seat Width	Seat Depth	Seat Height	Product Weight	Max. User Wt.	Supp. Code	✓ RAP #:
BEC046070	Economy, Slate	440 mm	440 mm	480 - 605 mm	5.25 kg	110 kg	KA500PE05	BE02
BEC046071	Economy, Chmp	440 mm	440 mm	480 - 605 mm	5.25 kg	110 kg	KA500PE03	BE02



Bedside Commode Folding

- Folding bedside chair can be used for toileting
- Fold up frame for easy transporting or storage
- Swing up arms to allow for easy side transfers
- Comes with removable padded seat, lift up toilet seat flap, fixed bowl carrier and bowl
- Fitted with non-slip rubber tips
- Mild steel epoxy coated frame is phosphate treated for corrosion resistance
- Warranty: 12 months

Code	Description	Seat Width	Seat Depth	Seat Height	Product Weight	Max. User Weight	Supplier Code
BEC046140	Bedside Commode Folding	440 mm	440 mm	480 - 605 mm	9 kg	110 kg	KA500ZV03



Bedside Commode S/O Bowl

- Bedside chair can be used for toileting
- Features a swing out bowl for easy cleaning
- Comes with removable padded seat, lift up toilet seat flap, swing out bowl carrier and bowl
- Removable backrest for storage or transportation
- Fully height adjustable to suit user requirements
- Fitted with non-slip rubber tips

✓ DVA CONTRACTED

BE02..... BUY
Prescribers... OT/RN/CA/LMO
For approval rules refer to pg 7.

- Mild steel epoxy coated frame is zinc treated for corrosion resistance

Code	Description	Seat Width	Seat Depth	Seat Height	Product Wt.	Max User Wt.	Supp. Code	✓ RAP #:
BEC046060	S/O Bowl, Slate (phosphate)	440 mm	440 mm	480 - 605 mm	5.75 kg	110 kg	KA500P05	BE02
BEC046180	S/O Bowl Chmp (zinc)	440 mm	440 mm	480 - 605 mm	5.75 kg	110 kg	KA500ZV03	BE02
BEC046150	S/O Bowl, Slate (zinc)	440 mm	440 mm	480 - 605 mm	5.75 kg	110 kg	KA500ZG05	BE02



Bedside Commode Swing Up Arms

- Bedside chair can be used for toileting
- Features swing up arms to allow for easy side transfers and a front skirt to conceal the bowl
- Comes with removable padded seat, lift up toilet seat flap, fixed bowl carrier and bowl
- Removable backrest for storage or transportation
- Fully height adjustable to suit user requirements

✓ DVA CONTRACTED

BE02..... BUY
Prescribers... OT/RN/CA/LMO
For approval rules refer to pg 7.

- Mild steel epoxy coated frame is phosphate treated for corrosion resistance

Code	Description	Seat Width	Seat Depth	Seat Height	Product Wt.	Max. User Wt.	Supp. Code	✓ RAP #:
BEC046170	Swing up Arms Champagne	440 mm	440 mm	480 - 605 mm	10 kg	110 kg	KA500ZSV03	BE02
BEC046160	Swing up Arms Slate	440 mm	440 mm	480 - 605 mm	10 kg	110 kg	KA500ZSG05	BE02



Bedroom



Bedside Commode Deluxe

- Deluxe bedside chair can be used for toileting
- Fold back padded seat for easy access to commode bowl
- Contoured backrest for added comfort and support
- Comes with lift up toilet seat flap, fixed bowl carrier and bowl
- Fully height adjustable to suit user requirements
- Fitted with non-slip rubber tips
- Mild steel epoxy coated frame is zinc treated for corrosion resistance
- Warranty: 12 months

✓ DVA CONTRACTED

BE02 BUY
Prescribers... OT/RN/CA/LMO

BE04 BUY
Prescribers... OT/RN/CA/S/Phys/LMO

For approval rules refer to pg 7.

Code	Description	Seat Width	Seat Depth	Seat Height	Product Wt.	Max. User Wt.	Supplier Code	✓ RAP #:
BEC046120	Bedside Commode Deluxe, Champagne	440 mm	460 mm	480 - 650 mm	12 kg	110 kg	KA500ZDV03	BE02
BEC046080	Bedside Commode Deluxe, Slate	440 mm	460 mm	480 - 650 mm	12 kg	110 kg	KA500ZDG05	BE02
BEC046130	Bedside Commode Deluxe, Mulberry	440 mm	460 mm	480 - 650 mm	12 kg	110 kg	KA500ZDV04	BE02
BEC046020	Bedside Commode Maxi	500 mm	420 mm	450 - 600 mm	15 kg	135 kg	KA500ZD50V03	BE02
BEC046200	Bedside Commode Mobility Base - for KA500ZD/KA586 Grey						KA50MWG	BE04
BEC046190	Bedside Commode Deluxe Pan Carrier Set						KA50DBC	BE04



Bedside Commode Maxi Fixed Height

- Large bedside chair can be used for toileting
- Extra seat width appropriate for maximum user weight of up to 210kg
- Fold back padded seat for easy access to commode bowl
- Contoured backrest for added comfort and support
- Comes with lift up toilet seat flap, fixed bowl carrier and bowl with removable lid and carry handle
- Fully height adjustable to suit user requirements

✓ DVA CONTRACTED

BE02 BUY
Prescribers... OT/RN/CA/LMO

For approval rules refer to pg 7.

- Fitted with non-slip rubber tips
- Reinforced mild steel epoxy coated frame is zinc treated for corrosion resistance
- Champagne colour vinyl
- Warranty: 12 months

Code	Description	Seat Width	Seat Depth	Seat Height	Product Wt.	Max. User Wt.	Supplier Code	✓ RAP #:
BEC046030	Bedside Commode Maxi Fixed Height 550	550 mm	490 mm	500 mm	15 kg	175 kg	KA500ZD55V03	BE02
BEC046040	Bedside Commode Maxi Fixed Height 600	600 mm	490 mm	500 mm	15 kg	195 kg	KA500ZD60V03	BE02
BEC046050	Bedside Commode Maxi Fixed Height 650	650 mm	490 mm	500 mm	15 kg	210 kg	KA500ZD65V03	BE02

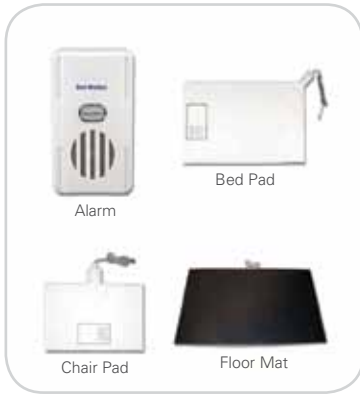

Cura Alarms - Safetime Kit

- Bed/chair pad alarm system activates when a resident or patient falls or gets out of a bed or chair
- Easily activated switch for the caregiver to switch the unit on/off or to reset
- System activates when a resident or patient removes their weight from the connected sensor pad
- Re-arms itself if the resident / patient gets back onto the sensor pad
- Ultra sensitive and durable sensors reduce false alarms to nil over the lifetime of the pad
- Anti allergic soft PVC construction for optimum comfort

✓ DVA CONTRACTED

AA16 BUY

Prescribers... OT/RN/Phys/LMO

For approval rules refer to pg 7.

- Venting facilities reduce the risk of moisture ingress
- Supplied with 9 volt battery
- Optional DV plug pack for permanent (240 volt) power source
- Available as bed sensor pad, chair pad or floor mat

Code	Description	Width	Length	Warranty	Max. User Wt.	✓ RAP #:
BEA007420	SafeTime Bed/Chair Monitor					AA16
BEA007422	SafeTime Bed Pad	760 mm	510 mm	12 months	200 kg	AA16
BEA007424	SafeTime Wheelchair/Chair Pad	380 mm	255 mm	12 months	200 kg	AA16
BEA007418	Premium Heavy Duty Non Slip Floor Mat (1yr)	1220 mm	610 mm	12 months	200 kg	AA16



Cura Alarms - Premium Pads

- Works with all Cura Alarms
- Easy to clean
- Ventilated neck prevents moisture build up
- Non-allergenic Soft PVC
- 1 year Guarentee life expectancy

✓ DVA CONTRACTED

AA16 BUY

Prescribers... OT/RN/Phys/LMO

For approval rules refer to pg 7.

Code	Description	Width	Length	Max. User Wt.	✓ RAP #:
BEA007412	Premium Bed Pad (1yr) Long	760 mm	510 mm	200 kg	AA16
BEA007414	Premium Bed Pad - (1yr) Short	760 mm	255 mm	200 kg	AA16
BEA007416	Premium Wheelchair/Chair Pad (1yr)	380 mm	255 mm	200 kg	AA16



Cura Alarms - Cordless Kit

- Wireless Bed/chair pad alarm system removes tripping hazards
- Can connect to nurse call system
- Simple operation and maintenance
- Adjustable volumes and tones
- Also works w/ premium bed/chairs pads

Note: the cordless monitor must be ordered with the cordless pad transmitter (BEA007430)

✓ DVA CONTRACTED

AA16 BUY

Prescribers... OT/RN/Phys/LMO

For approval rules refer to pg 7.

Code	Description	Width	Length	Max. User Wt.	✓ RAP #:
BEA007412	Premium Bed Pad (1yr) Long	760 mm	510 mm	200 kg	AA16
BEA007414	Premium Bed Pad - (1yr) Short	760 mm	255 mm	200 kg	AA16
BEA007416	Premium Wheelchair/Chair Pad (1yr)	380 mm	255 mm	200 kg	AA16



Cura Patient Activated Monitors

- Patient activated alert monitor assists with falls prevention
- Attached to patients clothing, patient activates by pulling string which detaches magnet and sets off alarm
- Stand alone system is simple to use
- Durable and reliable
- Portable and lightweight
- Supplied with 9 volt battery

DVA CONTRACTED

AA16 BUY

Prescribers... OT/RN/Phys/LMO

For approval rules refer to pg 7.

Code	Description	Warranty	RAP #:
BEA007460	Pull String Bed Monitor	12 months	-
BEA007410	Standard Bed Monitor	12 months	AA16
BEA007495	Voice Bed Monitor	12 months	-
BEA007485	Nurse Call Cable	12 months	-



Wireless Pager Kit

- Wireless paging system helps create independence for busy carers
- System consists of 2 transmitters, 1 portable carer pager with belt clip, 2 transmitter lanyards and 2 transmitter wall brackets
- Carers pager activates when the button on either transmitter is pressed
- Paging transmitters can be worn as a pendant around the neck or wall mounted
- 50 metre range
- Batteries included (2 x A23 for transmitters; 2 x AA for receiver)

Code	Description	Warranty
BEA007465	Wireless Pager Kit	12 months



Bedside Safety Crash Mat

- Foam mat prevents serious injury to patient in the event of a fall from bed
- Three sections of safety foam with a nylon cover laced on the ground beside the bed
- Placed on the ground beside the bed
- Especially useful with hi / low beds where nursing protocols prohibit the use of side rails
- Reflective strip for easier low light visibility
- Fold up with ties for easy storage when not required

Code	Description	Warranty
BEA008550	Bedside Safety Crash Mat	12 months



Chairs - Therapeutic



- P 093 Chairs - Day / Utility / Hi Lite & Accessories
- P 098 Chairs - Powerlift & Recline
- P 101 Chairs - Manual Recline
- P 102 Chairs - Pressure Relief
- P 104 Chairs / Couches - Waiting Room
- P 106 General Accessories



Hilite Chair

- High back lightweight orthopaedic chair
- Lightweight and sturdy design for function and comfort
- Contoured padded back rest for lumbar and neck support
- Fully adjustable seat height and angle
- Available with depth adjustment, reclining back, mobile with footrest
- Maxi version available up to 150 kg (CHP190900)
- Rubber stoppers for stability
- Easy to clean vinyl upholstery
- Powder coated steel frame
- Warranty: 12 months

✓ DVA CONTRACTED

AC01..... BUY
Prescribers... OT/Phys/RN/S/LMO/Ch/Ost

AC10..... BUY (P.A Rqd)
Prescribers... OT/Phys/RN/S/LMO/Ch/Ost

AC07..... BUY
Prescribers... OT/Phys/RN/S/LMO/Ch/Ost

For approval rules refer to pg 7.



Mobility Base



Adjustable Removable Arms



Tray Storage Backrest KA58TS



Mobility Wheels CHP213200



Side Panel CHP212200



Easy Rise Seat CHP203800



Hilite Tray CHP212700



Neckrest CHP211400



Footrest GSP340690



Footstool CHP210300

Code	Description	Seat Width	Seat Depth	Backrest Height	Seat to Floor	Product Weight	Max. User Wt.	✓ RAP #:
CHP204500	Hilite Chair - Grey/Slate	490 mm	480 mm	700 mm	430 - 580 mm	16 kg	120 kg	AC01
CHP204900	Hilite Chair - Vanilla/Champ	490 mm	480 mm	700 mm	430 - 580 mm	16 kg	120 kg	AC01
CHP203800	Hilite Chair - Easy Up - Grey/Slate	490 mm	480 mm	700 mm	430 - 580 mm	16 kg	120 kg	-
CHP204200	Hilite Chair - Easy Up - Vanilla/Champ	490 mm	480 mm	700 mm	430 - 580 mm	16 kg	120 kg	-
CHP190900	Hilite Chair - Grey/Slate (Maxi)	530 mm	480 mm	700 mm	430 - 580 mm	17 kg	150 kg	AC01
CHP191000	Hilite Chair - Vanilla/Champ (Maxi)	530 mm	480 mm	700 mm	430 - 580 mm	17 kg	150 kg	AC01
CHP206800	Hilite Chair - Mobile w/ Footrest - Grey/Slate	490 mm	480 mm	700 mm	430 - 580 mm	20 kg	120 kg	-
CHP207200	Hilite Chair - Mobile w/ Footrest - Vanilla/Champ	490 mm	480 mm	700 mm	430 - 580 mm	20 kg	120 kg	AC01
CHP202900	Hilite Chair - Depth Adj Back - Vanilla/Champ	490 mm	480-520 mm	700 mm	430 - 580 mm	17 kg	120 kg	AC01
CHP202800	Hilite Chair - Depth Adj Back - Grey/Slate	490 mm	480-520 mm	700 mm	430 - 580 mm	17 kg	120 kg	AC01
CHP203100	Hilite Chair - Depth Adj Removable Arms - Grey/Slate	490 mm	480-520 mm	700 mm	430 - 580 mm	17 kg	120 kg	-
CHP203500	Hilite Chair - Depth Adj Removable Arms - Vanilla/Champ	490 mm	480-520 mm	700 mm	430 - 580 mm	17 kg	120 kg	-
CHP206000	Hilite Chair - Reclining Back - Grey/Slate	490 mm	480 mm	700 mm	430-580 mm	17 kg	120 kg	-
CHP206400	Hilite Chair - Reclining Back - Vanilla/Champ	490 mm	480 mm	700 mm	430-580 mm	17 kg	120 kg	-
CHP205300	Hilite Chair - Depth Adj Back w/ Recline & Removable Arms - Grey/Slate	490 mm	480 mm	700 mm	430-580 mm	17 kg	120 kg	-
CHP205700	Hilite Chair - Depth Adj Back w/ Recline & Removable Arms - Vanilla/Champ	490 mm	480 mm	700 mm	430-580 mm	17 kg	120 kg	-

Hilite Chair Accessories		Supplier Code	RAP #:
CHP211400	Hilite Chair Neckrest - Grey/Slate	KA58N	AC10
CHP211200	Hilite Chair Neckrest - Vanilla/Champ	KA58NV03	AC10
CHP213200	Hilite Chair Rear Adj Legs w/ Wheels (Grey)	KA58W	-
CHP213300	Hilite Chair Rear Adj Legs w/ Wheels (Vanilla)	KA58WV03	-
CHP212200	Hilite Chair Side Panels - Grey/Slate	KA58SP	-
CHP212000	Hilite Chair Side Panels - Vanilla/Champ	KA58SPV03	-

Hilite Chair Accessories		Supplier Code	RAP #:
CHP212700	Hilite Chair Tray Adjustable - Grey/Slate	KA58T	AC10
CHP210300	Legrest for Hilite Chair (Grey/Slate)	KA58L	AC07
CHP210700	Legrest for Hilite Chair (Vanilla/Champagne)	KA58LV03	AC07
GSP345680	Footrest 200 mm Black	KA560L	AC07
GSP345690	Footrest 125 mm Black	KA560S	AC07



BC1

- Stylish orthopaedic ergonomic chair
- Padded armrests and padded fully welded one piece shell
- Fully adjustable seat height
- Powder coated steel frame
- Available in low (pictured) or high back versions
- Range of upholstered finishes and colours available
- Please specify colour at time of order

✓ DVA CONTRACTED

AC02..... BUY
Prescribers... OT/Phys/RN/S/LMO/Ch/Ost

AC01..... BUY
Prescribers... OT/Phys/RN/S/LMO/Ch/Ost

For approval rules refer to pg 7.



Code	Description	Seat Width	Backrest Height	Seat to Floor	Product Weight	Max. User Wt.	✓ RAP #:
CHP196700	BC1 Low Back - Standard Fabrics	535 mm	550 mm	380 - 530 mm	15 kg	160 kg	AC02
CHP196701	BC1 Low Back - Standard Vinyls	535 mm	550 mm	380 - 530 mm	15 kg	160 kg	AC02
CHP196500	BC1 High Back - Standard Fabrics	535 mm	630 mm	380 - 530 mm	16 kg	160 kg	AC01
CHP196501	BC1 High Back - Standard Vinyls	535 mm	630 mm	380 - 530 mm	16 kg	160 kg	AC01
CHP196702	BC1 Low Back - Zircon Waterproof Colours	535 mm	550 mm	380 - 530 mm	15 kg	160 kg	-
CHP196502	BC1 High Back - Zircon Waterproof Colours	535 mm	630 mm	380 - 530 mm	16 kg	160 kg	-



BC2

- High back orthopaedic ergonomic chair
- Three segment padded back cushion, padded arm rests and seat for added comfort
- All cushions are removable from welded one piece shell for easy cleaning
- Fully adjustable seat height
- Powder coated steel frame
- Range of upholstered finishes and colours available
- Please specify colour at time of order

✓ DVA CONTRACTED

AC01..... BUY
Prescribers... OT/Phys/RN/S/LMO/Ch/Ost

For approval rules refer to pg 7.



Code	Description	Seat width	Backrest height	Seat to floor	Warranty	Product Wt.	Max. User Wt.	✓ RAP #:
CHP196799	BC2 - Standard Fabrics	525 mm	650 mm	430 - 580 mm	12 months	16.5 kg	160 kg	AC01
CHP196800	BC2 - Standard Vinyls	525 mm	650 mm	430 - 580 mm	12 months	16.5 kg	160 kg	AC01
CHP196802	BC2 - Zircon waterproof colours	525 mm	650 mm	430 - 580 mm	12 months	16.5 kg	160 kg	AC01
CHP190600	BC2 Large - Standard Colours	595 mm	780 mm	430 - 580 mm	12 months	18.5 kg	220 kg	AC01
CHP190602	BC2 Large - Zircon waterproof colours	595 mm	780 mm	430 - 580 mm	12 months	18.5 kg	220 kg	-



BC4

- High back orthopaedic ergonomic chair
- Padded back cushion, arm rests & seat for added comfort
- Fully adjustable seat height & depth
- Lightweight aluminium frame, strong & corrosion resistant
- Range of upholstered finishes & colours available
- Please specify colour at time of order
- Warranty: 12 months



Code	Description	Seat Width	Backrest Height	Seat to Floor	Total Width	Product Wt.	Max. User Wt.
CHP196810	BC4 - Standard Colours	515 mm	365 - 535 mm	700 mm	695 mm	13 kg	120 kg
CHP196815	BC4 - Zircon waterproof colours	515 mm	365 - 535 mm	700 mm	695 mm	13 kg	120 kg



Power Stand Assist Chair

- The Power Stand Assist is a seat lift designed for use throughout your entire home
- The chair can easily assist with standing up from the dining room table or transferring into a wheelchair in the living room
- Features stylish wood design and comfortable fabric cushions, the Power Stand Assist is the perfect addition to any décor



Code	Description	Seat Width	Seat Depth	Backrest Height	Seat to Floor	Max. User Wt.
CHP193215	Power Stand Assist Chair - Standard Fabrics	545 mm	460 mm	535 mm	490 mm	136 kg



Utility Chair Maxi

- Low back extra wide orthopaedic chair
- Two extra wide sizes available
- Fully adjustable seat height
- Padded armrests, back and seat
- Rubber stoppers for stability
- Easy to clean vinyl upholstery
- Reinforced powder coated steel frame
- Warranty: 12 months

✓ DVA CONTRACTED

AC02..... BUY

Prescribers... OT/Phys/RN/S/LMO/Ch/Ost

For approval rules refer to pg 7.

Code	Description	Seat Width	Backrest Height	Seat to Floor	Product Weight	Max. User Weight	✓ RAP #:
CHP191400	Utility Chair Maxi 550	550 mm	470 mm	430 - 580 mm	11 kg	175 kg	AC02
CHP191500	Utility Chair Maxi 650	650 mm	470 mm	430 - 580 mm	11 kg	210 kg	AC02



Maxi Hiback

- Maxi high back orthopaedic bariatric chair
- Built-in lumbar support, lateral support and knee bolster
- Fully adjustable seat height, depth and angle for total comfort seating
- Extra wide arm rests are the full length of the frame
- Rubber stoppers for stability
- Powder coated steel frame

Code	Description	Seat Width	Seat Depth	Backrest Ht.	Seat to Floor	Warranty	Product Weight	Max. User Weight
CHP191150	Maxi Hiback	610 mm	460 - 550 mm	790 mm	450 - 600 mm	12 months	27 kg	250 kg



Throne Chair

- Large sized orthopaedic ergonomic comfort chair
- Padded armrests and ergonomically designed padded seat
- Fixed height chair for support to the bariatric user
- Reinforced steel frame for strength
- Powder coated steel frame

Code	Description	Seat Width	Seat Depth	Backrest Ht.	Seat to Floor	Warranty	Max. User Weight
CHP191200	Throne Chair	700 mm	470 mm	730 mm	480 mm	12 months	400 kg



Utility Chair Economy

- Low back multifunction orthopaedic chair
- Fully adjustable seat height
- Padded armrests, back and seat
- Rubber stoppers for stability
- Easy to clean vinyl upholstery
- Powder coated steel frame

DVA CONTRACTED
 AC02..... BUY
 Prescribers... OT/Phys/RN/S/LMO/Ch/Ost
 For approval rules refer to pg 7.

Code	Description	Seat Width	Seat Depth	Backrest Ht.	Warranty	Max. User Weight	RAP #:
CHP207800	Utility Chair Economy Slate	440 mm	450 mm	430 - 580 mm	12 months	120 kg	AC02



Utility Chair

- Low back multifunction orthopaedic chair
- Fully adjustable seat height
- Curved padded backrest provides postural support
- Rubber stoppers for stability
- Easy to clean vinyl upholstery
- Powder coated steel frame

DVA CONTRACTED
 AC02..... BUY
 Prescribers... OT/Phys/RN/S/LMO/Ch/Ost
 For approval rules refer to pg 7.

Code	Description	Seat Width	Backrest Height	Seat to Floor	Warranty	Max. User Weight	RAP #:
CHP208500	Utility Chair Champagne	440 mm	450 mm	430 - 580 mm	12 months	120 kg	AC02
CHP207900	Utility Chair Slate	440 mm	450 mm	430 - 580 mm	12 months	120 kg	AC02
CHP207500	Utility Chair with desk arm - Grey/Slate	440 mm	450 mm	430 - 580 mm	12 months	120 kg	-
CHP207600	Utility Chair with desk arm - Vanilla/Champ	440 mm	450 mm	430 - 580 mm	12 months	120 kg	-
CHP208750	Utility Chair Rear Adj Legs with Wheels (Vanilla)						-



Comfort Chair

- High back orthopaedic comfort chair
- Excellent lumbar and neck support
- Fully adjustable seat height
- Hard wearing vinyl with thick foam padding on the seat, back and arms
- Rubber stoppers for stability
- Easy to clean vinyl upholstery
- Powder coated steel frame
- Available in Grey or Beige (pictured), please specify at time of order

Code	Description	Seat Width	Backrest Height	Seat to Floor	Warranty	Max. User Weight
CHP192900	Comfort Chair	580 mm	670 mm	480 - 600 mm	12 months	130 kg
CHP193000	Legrest for Comfort Chair					



Bridge Chair

- Multifunction orthopaedic multifunction chair
- Low and high back versions available
- Lightweight with fully adjustable seat height
- Padded armrests, back and seat
- Rubber stoppers for stability
- Easy to clean vinyl upholstery available in Grey (pictured) or Beige
- Powder coated steel frame



✓ DVA CONTRACTED
AC02..... BUY
Prescribers... OT/Phys/RN/S/LMO/Ch/Ost
For approval rules refer to pg 7.

Code	Description	Seat Width	Backrest Ht.	Seat to Floor	Warranty	Max. User Weight	✓ RAP #:
CHP192600	Westgate Bridge Chair	450 mm	375 mm	460 - 580 mm	12 months	100 kg	AC02
CHP192700	Harbor Bridge Chair	450 mm	520 mm	460 - 580 mm	12 months	100 kg	AC02



Todd Chair

- High back orthopaedic ergonomic comfort chair
- Built-in lumbar support, lateral support and knee bolster
- Fully adjustable seat depth and height
- Rubber stoppers for stability
- Easy to clean vinyl upholstery
- Powder coated steel frame
- Also available in pressure care model featuring pressure sensitive foams and 2-way stretch fabrics for the contact surfaces, combined with washable decorator fabrics on the outer surfaces.
- Range of colours: Fabric: Tasman, Fern, Chocolate, Fawn, Rust.
Vinyl: Sakara, Opal, Stonewash, Blue, Stonewash Rush, Mist

✓ DVA CONTRACTED
AC01..... BUY
Prescribers... OT/Phys/RN/S/LMO/Ch/Ost
For approval rules refer to pg 7.

Code	Description	Seat to Floor	Seat Depth	Between Arms	Total Ht.	Overall Width	Wt. Capacity	✓ RAP #:
CHP193100	Todd Chair	410 - 585 mm	395 - 510 mm	480 mm	1070 - 1250 mm	660 mm	130 kg	AC01
GSP	Todd Pressure Care	410 - 585 mm	395 - 510 mm	480 mm	1070 - 1250 mm	660 mm	130 kg	AC01



Fitzroy Bridge Chair

- The Fitzroy Bridge chair is a great choice as a Rehabilitation, Ward/Visitors chair, or in the Home as a Dining or activity chair
- Built-in Lumbar support together with the shoulder supporting curve of the backrest.
- Adjustable seat height
- Wide padded armrests

✓ DVA CONTRACTED
AC01..... BUY
Prescribers... OT/Phys/RN/S/LMO/Ch/Ost
For approval rules refer to pg 7.

Code	Description	Seat to Height	Seat Length	O/all Width	Back Height	Internal Width	Seated Capacity	✓ RAP #:
GSP	Fitzroy Bridge Chair	405 - 535mm	460 mm	600 mm	500 mm	415 - 460 mm	130 kg	AC01



Kitchen Stool

- Ideal for use in the kitchen or similar work area where a standard chair is not suitable
- Fully adjustable seat height to suit individual user requirements
- Padded seat and backrest for added comfort
- Rubber stoppers for stability
- Easy to clean vinyl upholstery
- Powder coated steel frame



✓ DVA CONTRACTED
AC03..... BUY
Prescribers... OT/Phys/RN/S/LMO/Ch/Ost
For approval rules refer to pg 7.

Code	Description	Seat Width	Seat Depth	Backrest Height	Seat to Floor	Warranty	Product Weight	Max. User Weight	✓ RAP #:
CHP213500	Kitchen Stool with Arms	360 mm	300 mm	400 mm	520 - 640 mm	12 months	5.6 kg	100 kg	AC03
CHP213400	Kitchen Stool without Arms	360 mm	300 mm	400 mm	520 - 640 mm	12 months	5.2 kg	100 kg	AC03



Pride Powerlift Chairs



Pride Lift Chairs are designed to be the ultimate in lift chair comfort, style and performance. Available in several beautiful fabrics and styles to fit any decore, Pride Lift Chairs also feature a 2 year warranty. The state of the art lift system utilised in Pride Lift Chairs will recline you further back than any other lift chair. Plus, Pride Lift Chairs are equipped with an emergency battery backup system should the power fail in your home.

Specifications



	C1 Petite	C5	C6	C - 101	LC - 101 Leather
Aidacare Code	CHP197210	CHP197100	CHP197200	CHP179212	CHP197215
Back Width	510 mm	710 mm	710 mm	720 mm	580 mm
Seat to Floor	410 - 460 mm	460 - 510 mm	480 mm	470 mm	470 mm
Depth	510 mm	460 - 510 mm	530 mm	510 mm	510 mm
Width	460 mm	560 mm	560 mm	510 mm	510 mm
Backrest height	660mm	660 - 710 mm	660 - 710 mm	700 mm	700 mm
Weight Capacity	113 kg	170 kg	136 kg	147 kg	147 kg



	D30	560	660	LL 805	T3
Aidacare Code	CHP198000	CHP193300	CHP193700	Enquiry	Enquiry
Back Width	740 mm	710 mm	710 mm	775 mm	690 mm
Seat to Floor	480 mm	480 mm	480 mm	480 mm	480 mm
Depth	560 mm	480 mm	510 mm	510 mm	510 mm
Width	560 mm	480 mm	510 mm	510 mm	510 mm
Backrest height	660 mm	635 mm	635 mm	685 mm	685 mm
Weight Capacity	170 kg	170 kg	170 kg	136 kg	170 kg

Lift Chair Descriptions

PLEASE NOTE - 2 position is a TV recline
 - 3 position is a full recline
 - Infinite position is a full recline with independent legrest function

DVA CONTRACTED

AC06..... HIRE (P.A Rqd)

Prescribers... OT/Phys/S/LMO/Ch/Ost

For approval rules refer to pg 7.



C1 Petite (CHP197210) AC06

Accented Pillow - Back Design Shown in Chocolate

- 3 positon (single motor), petite to small lift chair with fully removable upholstery components
- Engineered furniture laminate/ hardwood frame
- 2 year limited warranty
- COLOUR OPTIONS: Arctic Blue, Chocolate, Oatmeal



D30 (CHP198000)

Split - Back Design Shown in Burgundy

- 3 position (single motor), medium to large chaise lounge
- Engineered furniture laminate/ hardwood frame
- 2 year limited warranty
- COLOUR OPTIONS: Ocean, Burgundy, Spruce, Latte, Burgundy (Levante Vinyl), Royal Blue, Pine Mountian



C5 (CHP197100)

Sewn Pillow - Back Design
Shown in Arctic Blue

- 3 position (single motor), medium to large chaise lounge with fully removable upholstery components
- Engineered furniture still frame
- 2 year limited warranty
- COLOUR OPTIONS: Arctic Blue, Chocolate, Oatmeal



560 (CHP193300)



Sewn Pillow - Back Design
Shown in Spruce

- 3 position (single motor), small to medium chaise lounge
- Engineered furniture laminate/ hardwood frame
- 2 year limited warranty
- COLOUR OPTIONS: Ocean, Burgundy, Spruce



C6 (CHP197200)



Sewn Pillow - Back Design
Shown in Arctic Blue

- Infinite position (2 motor), medium to large chaise lounge with fully removable upholstery components and dual motors which enable independent recline/footrest function
- Engineered furniture still frame
- 2 year limited warranty
- COLOUR OPTIONS: Arctic Blue, Chocolate, Oatmeal, Royal Blue (Levante Vinyl)



660 (CHP193700)

Pillow - Back Design
Shown in Latte

- The 660 combines the independent leg elevating function of the C6 (dual motor) with the zippered pillow back system of the 560 to provide the user with the ultimate comfort and posture solution
- Engineered furniture laminate/ hardwood frame
- 2 year limited warranty
- COLOUR OPTIONS: Latte



C - 101 (CHP197212)



Button - Back Design
Shown in Sandal

- 3 position (single motor), medium to large lift chair
- Engineered furniture laminate/ hardwood frame
- 2 year limited warranty
- COLOUR OPTIONS: Cocoa, Fern, Sandal



LL805 (CHP193800)

Split - Back Design
Shown in Cocoa

- 2 position, medium to large wall hugger chaise lounge which requires only 100 mm of space between wall and chair
- Engineered furniture laminate/ hardwood frame
- 2 year limited warranty
- COLOUR OPTIONS: Cocoa, Fern Sandal



LC - 101 (CHP197215)

Split - Back Design
Shown in Beige Leather

- 3 position (single motor), medium to large lift chair
- Engineered furniture laminate/ hardwood frame
- 2 year limited warranty
- COLOUR OPTIONS: Beige (Leather), Brown, Black, Red



T3 (CHP193220)

Mongolian - Back Design
Shown in Black Leather

- Infinite Position medium to large lift chair reclines to a full Trendelenburg position that is designed to elevate the legs to a point above the head
- Engineered furniture laminate/ hardwood frame
- 2 year limited warranty
- COLOUR OPTIONS: Oatmeal, Black (Leather)



Fabric			Suede			Leather		Levante Vinyl	
Spruce	Ocean	Oatmeal	Chocolate	Arctic Blue	Expresso	Black	Beige	Burgundy	Royal Blue
Burgundy	Latte		Fern	Cocoa	Sandal	Red	Brown	Pine Mountain	





Powerlift Recliner Ashley

- Powered armchair assists the user in sitting and standing
- Provides comfort and support for a wide range of body shapes and sizes
- Quiet and smooth lift system with infinite rise and recline positions for ultimate comfort
- Single switch handle control for easy use
- Australian made with solid timber frame
- Available in Topsuede: Mink Brown, Lagoon Green, Denim Blue

✓ DVA CONTRACTED

AC06..... HIRE (P.A Rqd)
Prescribers... OT/Phys/S/LMO/Ch/Ost

AC10..... BUY (P.A Rqd)
Prescribers... OT/Phys/S/RN/LMO/Ch/Ost

For approval rules refer to pg 7.

- Available in Catavina (Floral) - Solitude; Lodge (Velvet) - Cypress
- Other custom colours available on request
- Warranty: 12 months

Code	Description	Recommended User Height	Seat Width	Seat Depth	Seat to Top of Back	Max. User Weight	✓ RAP #:
CHP195900	Powerlift Recliner Ashley Petite 1 Motor	153 cm	440 mm	470 mm	580 mm	140 kg	AC06
CHP195300	Powerlift Recliner Ashley Maxi 1 Motor	180 - 188 cm	530 mm	560 mm	720 mm	140 kg	AC06
CHP195400	Powerlift Recliner Ashley Maxi 2 Motor	180 - 188 cm	530 mm	560 mm	720 mm	140 kg	-
CHP195500	Powerlift Recliner Ashley Medium 1 Motor	163 - 178 cm	480 mm	520 mm	660 mm	140 kg	AC06
CHP195600	Powerlift Recliner Ashley Medium 2 Motor	163 - 178 cm	480 mm	520 mm	660 mm	140 kg	-
CHP195700	Powerlift Recliner Ashley Mini 1 Motor	153 - 160 cm	480 mm	470 mm	600 mm	140 kg	AC06
CHP195800	Powerlift Recliner Ashley Mini 2 Motor	153 - 160 cm	480 mm	470 mm	600 mm	140 kg	-
CHP196000	Powerlift Recliner Ashley Petite 2 Motor	153 - 160 cm	480 mm	470 mm	600 mm	140 kg	-
CHP196100	Powerlift Recliner Ashley Tall 1 Motor	191 - 198 cm	540 mm	570 mm	740 mm	140 kg	AC06
CHP196200	Powerlift Recliner Ashley Tall 2 Motor	191 - 198 cm	540 mm	570 mm	740 mm	140 kg	-
CHP196250	Chair Pillow - Ashley Recliners						AC10
CHP195200	Arm & Headrest Covers for Ashley Recliner						AC10



Powerlift Recliner Ashley Bariatric

- Powered armchair assists the bariatric user in sitting and standing
- Quiet and smooth lift system with infinite rise and recline positions for ultimate comfort
- Available with separate motor designs - Single (back and legs rise/recline simultaneously) or; Dual (back and legs rise/recline independently)
- Australian made with solid timber frame
- Side storage pocket
- Single switch handle control for easy use
- Available in Topsuede: Mink Brown, Lagoon Green, Denim Blue
- Available in Catavina (Floral) - Solitude; Lodge (Velvet) - Cypress
- Other custom colours available on request
- Reinforced steel frame for additional support

Code	Description	Seat Width	Seat Depth	Seat to Top of Back	Warranty	Max. User Weight
CHP190400	Powerlift Recliner Ashley Large	670 mm	600 mm	700 mm	24 months	200 kg
CHP190500	Powerlift Recliner Ashley X-Large	860 mm	650 mm	720 mm	24 months	275 kg



Powerlift Recliner Airwing Compact (pressure relieving)

- Powered armchair assists the user in sitting and standing
- Patented Air Comfort system provides comfort and pressure relief in backrest, seat and footrest
- Quiet and smooth lift system with infinite rise and recline positions for ultimate comfort
- Single switch handle control for easy use
- Boston-Fusion two-way stretch waterproof material

✓ DVA CONTRACTED

AC06..... HIRE (P.A Rqd)
Prescribers... OT/Phys/S/LMO/Ch/Ost

For approval rules refer to pg 7.

- Also available in Macro Suede: Large range of colours available
- Available in three sizes: Small, Medium, Large
- Mobile version comes with 100 mm castors

Code	Description	Seat Width	Seat Depth	Backrest Height	Seat to Floor	Warranty	Max. User Wt.	✓ RAP #:
CHP199700	Airwing Compact Small	500 mm	430 mm	710 mm	480 mm	24 months	120 kg	AC06
CHP199600	Airwing Compact Medium	500 mm	510 mm	710 mm	480 mm	24 months	120 kg	AC06
CHP199650	Airwing Compact Medium 2 Motor	500 mm	510 mm	710 mm	480 mm	24 months	120 kg	-
CHP199500	Airwing Compact Large	600 mm	510 mm	710 mm	480 mm	24 months	120 kg	-
CHP199675	Airwing Compact Medium - Mobile	500 mm	510 mm	710 mm	480 mm	24 months	120 kg	-



Nordic Mobicline

- High back reclining mobile chair
- Large activity tray
- Slide out footrest
- Four castors, two locking for stability
- Fully welded tubular frame
- Available in Vinyl and Zircon Fabric
- Fabric Colours: Sage Green, Light Blue, Fawn, Chocolate
- Vinyl Colours: Soft Cream, Beige, Latte, Blue, Red

Code	Description	Seat Width	Seat Depth	Seat to Floor	Warranty	Max. User Weight
CHP194700	Nordic Mobicline - Standard Colours	500 mm	540 mm	565 mm	12 months	130 kg
CHP194701	Nordic Mobicline - Zircon waterproof colours	500 mm	540 mm	565 mm	12 months	130 kg



Medi-Todd Patient Handling

- Stylish design
- Built-in lumbar & lateral support
- Wide range of fabrics & vinyls
- Optional meals tray
- Optional slide-out footrest
- Optional Adjustable height arms
- Optional HiCare Upholstery System

Code	Description	Seat Height	Seat Width	Backrest Height	Arm Height	Warranty	Max. User Weight
GSP	Med-Todd Patient Handling	480 - 655 mm	510 mm	750 mm	220 mm	12 months	135 kg
GSP	Med-Todd Patient Handling Adj. Arm	480 - 655 mm	510 mm	750 mm	220 mm	12 months	135 kg



Todd Recliner

- TODD Recliner has been designed to transform from a comfortable Home Recliner to a rugged mobile Patient Care chair
- Fully sprung seat, quality foam, shaped backrest with lumbar and lateral support and adjustable/removeable neckrest
- The recline action is operated simply by pushing back on the armrests
- Available colours: Decorator fabrics and Vinyls selected in the home

Code	Description	Seat Height	Seat Height with Casters	Seat Length	O/all Width	O/all Length	Internal Width	Max. User Weight
GSP	Todd Recliner	420 - 490 mm	620 mm	490 - 560 mm	720 mm	870 mm	520 mm	135 kg



Princess Chair

- Unique Air Comfort Seating System for total surface pressure reduction
- Tilt-in Space adjustable seat positioning with infinite locking
- Adjustable legrest with infinite raise and lower positions
- Four castors - Three braking, one directional
- Polyurethane, Anti-Microbial, Anti-Bacterial, Three-way stretch fabric

✓ DVA CONTRACTED
 AC08..... HIRE (P.A Rqd)
 Prescribers... OT/Phys/RN/S/LMO/Ch/Ost
 For approval rules refer to pg 7.

- Suits users: 142 cm to 162 cm
- Optional tray and footrest

Code	Description	Seat Width	Back Width	Back Height	Warranty	Max. User Weight	Max. User Weight	✓ RAP #:
CHP216200	Princess Chair	420 mm	490 mm	700 mm	24 months	180 kg	170 kg	AC08



Princess Bed

- Unique Air Comfort Seating System for total surface pressure reduction
- Tilt-in Space adjustable seat positioning with infinite locking
- Adjustable backrest for full recline
- Adjustable legrest with infinite raise and lower positions
- Four castors - Three braking, One directional

- Polyurethane, Anti-Microbial, Anti-Bacterial, Three-way stretch fabric
- Suits users: 142 cm to 162 cm

Code	Description	Seat width	Back width	Back height	Warranty	Max. User Weight
CHP216100	Princess Bed	420 mm	490 mm	700 mm	24 months	180 kg



Tilt Bed

- Unique Air Comfort Seating System for total surface pressure reduction
- Adjustable legrest with infinite raise and lower positions
- Adjustable backrest for full recline
- Tilt-in Space adjustable seat positioning with infinite locking
- Four castors - Three braking, one directional
- Polyurethane, Anti-Microbial, Anti-Bacterial, Three-way stretch fabric

✓ DVA CONTRACTED
 AC08..... HIRE (P.A Rqd)
 Prescribers... OT/Phys/RN/S/LMO/Ch/Ost
 AC10..... BUY
 Prescribers... OT/Phys/RN/S/LMO/Ch/Ost
 For approval rules refer to pg 7.

- Suits users: 142 cm to 162 cm
- Optional tray and footrest

Code	Description	Seat width	Back width	Back height	Warranty	Max. User weight	✓ RAP #:
CHP217000	Tilt Bed	460 mm	520 mm	780 mm	24 months	180 kg	AC08
CHP217300	Tray for Tilt Bed, Deluxe Bed						AC10
CHP217100	Footrest for Tilt Bed						AC10



Deluxe Bed Electric

- Unique Electric Air Comfort Seating System for total surface pressure reduction
- Electric Tilt-in Space adjustable seat positioning with infinite locking
- Electric adjustable backrest for full recline
- Electric hand control plus battery pack for greater mobility
- Adjustable legrest with infinite raise and lower positions

- Adjustable wings and arms for easy transfer
- Four castors - Three braking, One directional
- Polyurethane, Anti-Microbial, Anti-Bacterial, Three-way stretch fabric
- Suits users: 162 cm to 188 cm

Code	Description	Seat Width	Back Width	Back Height	Warranty	Max. User Weight
CHP198375	Deluxe Bed Electric	500 mm	510 mm	760 mm	24 months	180 kg



Deluxe Bed

- Unique Air Comfort Seating System for total surface pressure reduction
- Tilt-in Space adjustable seat positioning with infinite locking
- Adjustable wings and arms for easy transfer
- Adjustable backrest for full recline
- Adjustable legrest with infinite raise and lower positions
- Four castors - Three braking, One directional
- Polyurethane, Anti-Microbial, Anti-Bacterial,

✓ DVA CONTRACTED

AC08..... HIRE (P.A Rqd)
Prescribers... OT/Phys/RN/S/LMO/Ch/Ost

AC10..... BUY
Prescribers... OT/Phys/RN/S/LMO/Ch/Ost

For approval rules refer to pg 7.

- Three-way stretch fabric
- Suits users: 162 cm to 188 cm
 - Available in Small - Suits users up to 142 cm

Code	Description	Seat Width	Back Width	Back Height	Warranty	Max. User Weight	✓ RAP #:
CHP198200	Deluxe Bed	510 mm	500 mm	760 mm	24 months	180 kg	-
CHP198300	Deluxe Bed Small	460 mm	450 mm	660 mm	24 months	90 kg	AC08
CHP216350	Footrest for Deluxe Bed Small						AC10



Deluxe Bed Maxi

- Unique Air Comfort Seating System for total surface pressure reduction for larger users
- Maximum user weight 300 kg and seat width 750 mm
- Unique power assist tilt of seat, backrest and legrest
- Electric adjustable backrest for full recline
- Adjustable wings and arms for easy transfer
- Electric Tilt-in Space adjustable seat positioning with infinite locking
- Four castors - Three braking, One directional

✓ DVA CONTRACTED

AC08..... HIRE (P.A Rqd)
Prescribers... OT/Phys/RN/S/LMO/Ch/Ost

For approval rules refer to pg 7.

- Polyurethane, Anti-Microbial, Anti-Bacterial, Three-way stretch fabric
- Suits users: 162 cm to 188 cm
- Available in Small - Suits users up to 142 cm

Code	Description	Seat Width	Back Width	Back Height	Warranty	Max. User Weight	✓ RAP #:
CHP198350	Maxi Deluxe Bed	750 mm	650 mm	800 mm	24 months	300 kg	AC08



Footrest for Princess Chair, Bed & Deluxe Bed

- Easy to attach and remove
- Flips open to allow for easy transfer

✓ DVA For eligibility & prescriber info please refer to pg 7.



Tray for Princess Chair, Bed & Deluxe Bed

- Handy tray accessory for princess chair, bed and deluxe bed

✓ DVA For eligibility & prescriber info please refer to pg 7.

Code	Description	RAP #:	Code	Description	RAP #:
CHP216300	Footrest for Princess Chair, Princess Bed, Deluxe Bed	AC10	CHP216400	Tray for Princess Chair, Princess Bed	AC10

REFER TO PRESSURE CARE PAGE 170 FOR OUR FULL RANGE OF PRESSURE CARE PRODUCTS





Stanford Armchair

- Lightweight dining chair with curved armrests suitable for aged care setting
- Stackable
- Frame available in black powdercoating or chrome
- Large range of upholstery available

Code	Description	Total Height	Total Width	Seat Height	Warranty	Max. User Weight
CHP189800	Stanford Armchair	800 mm	590 mm	480 mm	12 months	120 kg



Saturn Armchair

- Lightweight dining chair with armrests suitable for aged care setting
- Stackable
- Frame available in black powdercoating or chrome
- Large range of upholstery available

Code	Description	Total Height	Total Width	Seat Height	Warranty	Max. User Weight
CHP189700	Saturn Armchair	845 mm	615 mm	485 mm	12 months	120 kg



Bankett Armchair

- Laminated plantation timber armchair
- Stackable
- Large range of upholstery available

Code	Description	Total Height	Total Width	Seat Height	Warranty	Max. User Weight
CHP189850	Bankett Armchair	700 mm	540 mm	470 mm	12 months	100 kg



Valencia Armchair

- Machined, laminated plantation timber armchair
- Also suitable as a bedside chair
- Large range of upholstery available

Code	Description	Total Height	Total Width	Seat Height	Warranty	Max. User Weight
CHP189900	Valencia Armchair	880 mm	560 mm	480 mm	12 months	100 kg



Alto Armchair

- Made from machined, laminated plantation timber
- Large range of upholstery available

Code	Description	Total Height	Total Width	Seat Height	Warranty	Max. User Weight
CHP189910	Alto Armchair	780 mm	520 mm	455 mm	12 months	100 kg



Augusta Armchair

- Elegant timber framed armchair suitable for a variety of functions
- Well proportioned and strongly made
- Large range of upholstery available

Code	Description	Total height	Total width	Seat height	Warranty	Max. User weight
CHP194401	Augusta Armchair	850 mm	610 mm	480 mm	12 months	100 kg



Alice Tub Chair

- Comfortable fully upholstered tub chair with a timber frame
- Large range of upholstery available

Code	Description	Total Height	Total Width	Seat Height	Warranty	Max. User Weight
CHP193900	Alice Tub Chair	830 mm	640 mm	440 mm	12 months	100 kg



Cornwall Lounge Chair

- Fully upholstered chair with Cabriole front legs
- Generous proportions with high seat back for extra support
- Available as a 2 seater
- Large range of upholstery available

Code	Description	Total Height	Total Width	Seat Height	Warranty	Max. User Weight
CHP194550	Cornwall Lounge Chair	1040 mm	800 mm	520 mm	12 months	100 kg
CHP194560	Cornwall Lounge Chair 2 Seater	1040 mm	1310 mm	520 mm	12 months	100 kg (per person)



Devon Lounge Chair

- Fully upholstered chair with wing back design
- Generous proportions with high seat back for extra support
- Available as a 2 seater
- Large range of upholstery available

Code	Description	Total Height	Total Width	Seat Height	Warranty	Max. User Weight
CHP198400	Devon Lounge Chair	1040 mm	800 mm	520 mm	12 months	100 kg
CHP198500	Devon Lounge Chair 2 Seater	1040 mm	1440 mm	520 mm	12 months	100 kg (per person)



Chair Raiser Cone

- These cone bed & chair raisers are held still by their anti-slip caster pads
- Exceptionally strong, the cone bed & chair raisers are lightweight, have a recess for the chair or bed leg and broad base
- Sold in sets of four

DVA For eligibility & prescriber info please refer to pg 7.

Code	Description	Height	RAP #:
CHP190800	Chair Raiser Cone	90 mm	AC04
CHP190850	Chair Raiser Blocks	75 mm	AC04



Bed/Chair Raiser

- Raisers are placed on the floor under the legs of beds or lounge chairs to raise their height
- Ideal for those recovering from hip replacements, knee operations or as a result of ageing

DVA For eligibility & prescriber info please refer to pg 7.

Code	Description	Height	RAP #:
BEA009700	Bed/Chair Raiser Blocks Wooden (Pkt 4)	75 mm	AB03
BEA009500	Bed/Chair Raiser Cones (Pkt 4)	90 mm	AB03
BEA009600	Bed/Chair Raiser Cones (Pkt 4)	140 mm	AB03



Footrest Padded

- Height adjustable foot rest with vinyl padded top

DVA For eligibility & prescriber info please refer to pg 7.

Code	Description	RAP #:
CHP201300	Padded Footrest Large Grey/Slate	AC10
CHP201700	Padded Footrest Large Vanilla/Champagne	AC10
CHP202000	Padded Footrest Small Grey/Slate	AC10
CHP202400	Padded Footrest Small Vanilla/Champagne	AC10

Aidacare Online

For all of your product enquiries in one user-friendly site visit us online at www.aidacare.com.au

- New product releases - updated daily
- Clear and concise product descriptions and specifications
- Contract specific ordering information (DVA, TAC & MASS)
- Downloadable DVA RAP and other order forms
- Full colour product images
- Information on our range of service offerings
- Newsletter subscription page

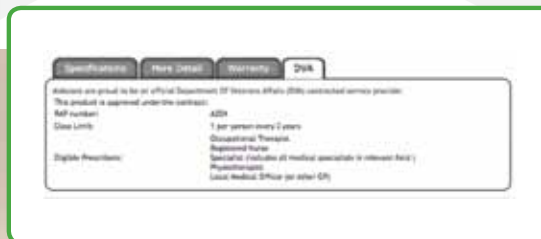

"We care for your care"



Continence

- P 109** Bedding Protectors
- P 110** Chair Protectors
- P 111** Clothing Protectors - Disposable
- P 113** Clothing Protectors - Reusable

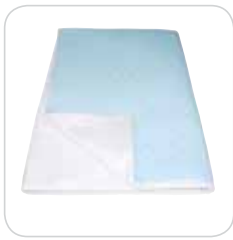

Bed Pad Deluxe

- Super absorbent soft, non pill quilted surface
- Features large tuck in flaps designed to hold the bed pad in the correct position on the bed

Code	Description	Length	Width	Capacity
CON228600	Bed Pad Deluxe	1000 mm	1000 mm	2800 ml
CON228700	Bed Pad Super Deluxe with Waterproof Backing	800 mm	900 mm	2500 ml
CON230800	Bed Pad Extra	1000 mm	1000 mm	3500 ml



Bed Pad Stayput, Waterproof Backing

- Designed for use at home on a single or double bed
- A waterproof non slip backing and bound edges
- A built in antibacterial barrier to retain freshness

Code	Description	Length	Width	Capacity
CON230900	Bed Pad Stayput, Waterproof Backing	700 mm	900 mm	2500 ml



Bed Pad Smart Barrier

- No PVC Backing - only breathable, waterproof PU (polyurethane), 2 way stretch fabric as used on premium hospital mattresses
- 100% brushed polyester facing ideal for client protection and comfort

Code	Description	Tuck-Ins	Colour	Length	Width	Capacity
CON225002	Bed Pad w/ Waterproof Backing	No	Light Blue	900 mm	850 mm	2500 ml
CON225004	Bed Pad w/ Waterproof Backing	Yes	Light Blue	900 mm	850 mm	2500 ml
CON225008	Bed Pad No Waterproof Backing	Yes	Navy Blue	900 mm	850 mm	2500 ml



Protect A Plas

- Waterproof soft two way stretch PVC
- Can be used as a mattress cover, mattress protector, draw sheet, apron or pillow case protectors

Code	Description	Height	Length	Width
BEM047682	PVC Mattress Cover 100	100 mm	1905 mm	915 mm
BEM047684	PVC Mattress Cover 125	125 mm	1905 mm	915 mm
BEM047690	PVC Mattress Cover 150	150 mm	1905 mm	915 mm
BEM047700	PVC Mattress Cover 175	175 mm	1905 mm	915 mm
BEM047702	PVC Mattress Protector 125	125 mm	1905 mm	915 mm
BEM047704	PVC Mattress Protector 175	175 mm	1905 mm	915 mm
BEM047710	PVC Draw Sheet		1520 mm	915 mm
WAT765500	PVC Apron		1000 mm	850 mm
BEP057400	PVC Pillowcase		750 mm	500 mm



Mate Bedpad

- Fluid Holding Capacity 2000 mls over 8 hrs
- 85 cm x 95 cm with bound edges for a longer life, suitable for all bed sizes
- Soft polyester top layer a highly absorbent core and a breathable PUL waterproof backing
- Fully Washable and Re-usable

Code	Description	Length	Width
085095-25-1	Mate Bedpad Mauve	850 mm	950 mm
085095-25-1TB	Mate Bedpad Teal Blue	850 mm	950 mm



Max Bedpad

- Fluid Holding Capacity 2500 mls over 8 hrs
- 1 m x 1 m bed pad for single or king single beds
- Durable polyester tuck-ins each side to tuck under the mattress for extra security
- Soft polyester top layer, highly absorbent core and a breathable PUL waterproof backing
- Fully Washable and Re-usable

Code	Description	Length	Width
100100-25-1	Max Bedpad Mauve	1000 mm	1000 mm
100100-25-1TB	Max Bedpad Teal Blue	1000 mm	1000 mm

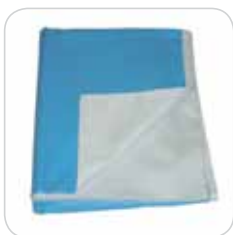

MacIntosh Waterproof Protector

- Aimed at increasing the life span and decreasing the drying time of the bed pad
- Comes standard with tuck-ins to secure firmly on the bed
- Ideal for use with CON225008, CON228600, CON230800 & CON231100

Code	Description	Length	Width
CON229100	MacIntosh Waterproof Protector	900 mm	1000 mm



Wipeclean Pillow

- Pillow easily wipes clean for effective infection control
- Bacteria & fire retardant
- Waterproof cover sewn onto the pillow reduces the need for a separate cover
- Air easily circulates through the ends of the pillow for breathability

Code	Model
BEP057701	Wipeclean Pillow



Toggle Mattress Protector

- Soft, quiet, breathable and completely waterproof
- Rustle-free and will not become brittle
- Free form elastic so are easy to fit and long lasting



Floor Mat

- Made of a heavy-duty, super absorbent top and anti-slip nitrile rubber base
- Designed to sit firm and flat on the floor to help prevent trips and allow frames and walkers to travel over safely

Code	Description	Length	Width
092188-00-1	Toggle Mattress Protector Single	920 mm	1880 mm
107203-00-1	Toggle Mattress Protector King Single	1070 mm	2030 mm
137188-00-1	Toggle Mattress Protector Double	1370 mm	1880 mm
153203-00-1	Toggle Mattress Protector Queen	1530 mm	2030 mm
183203-00-1	Toggle Mattress Protector King	1830 mm	2030 mm

Code	Description	Length	Width
060090-00-1	Floor Mat	600 mm	900 mm



Chair Pad Large

- Fluid holding capacity 1000 mls
- Suitable for: vehicles, wheelchairs or general furniture
- Soft polyester top layer, highly absorbent core and breathable PUL waterproof backing
- Fully Washable and Re-usable



Chair Pad Small

- Fluid Holding Capacity 1000 mls
- Suitable for: vehicles, wheelchairs or general furniture
- Soft polyester top layer, highly absorbent core and breathable PUL waterproof backing
- Fully Washable and Re-usable

Code	Description	Length	Width
051061-25-1P	Chair Pad Large Tartan	510 mm	610 mm
051061-25-1TB	Chair Pad Large Teal Blue	510 mm	610 mm

Code	Description	Length	Width
048048-25-1P	Chair Pad Small Tartan	480 mm	480 mm
048048-25-1TB	Chair Pad Small Teal Blue	480 mm	480 mm



Chair Pad

- No PVC Backing - only breathable, waterproof PU (polyurethane), 2 way stretch fabric as used on premium hospital mattresses
- 100% brushed polyester facing ideal for client protection and comfort
- Waterproof backing
- Washable to over 150 times
- Hand, machine or industry wash and dry



Chair Pad

- Non-slip waterproof backing designed to sit on a chair
- Large capacity of 1.5 L
- Available in three colours

Code	Description	Length	Width
CON225010	Chair Pad Burgundy	500 mm	600 mm
CON225012	Chair Pad Navy Blue	500 mm	600 mm
CON225014	Chair Pad Green	500 mm	600 mm

Code	Description	Length	Width	Capacity
CON230300	Chair Pad Plain	600 mm	500 mm	1500 ml
CON230400	Chair Pad Floral	600 mm	500 mm	1500 ml
CON230500	Chair Pad Tartan	600 mm	500 mm	1500 ml



Clothing Protector

- Shield clothing from unwanted stains and odours
- 100% cotton facing



Modesty Cape

- To be used in facilities to cover the patient during transport to the shower

Code	Description	Length	Width
CON225016	Clothing Protector Yellow Plaid	900 mm	450 mm
CON225018	Clothing Protector Blue Tartan	900 mm	450 mm
CON229900	Clothing Protector Plain	900 mm	450 mm
CON230000	Clothing Protector Floral	900 mm	450 mm
CON230100	Clothing Protector Tartan	900 mm	450 mm

Code	Description
CON236900	Modesty Cape



Cello Prevail Pants

- Broad soft waistband providing security and maximum comfort whilst the elasticized legs and standing leg cuffs ensure a snug fit
- Super absorbent gel to reduce odour and keep the skin dry



Cello Form Pads

- Features an ultra dryness system, elasticized legs and a visual wetness indicator

Code	Description	Waist	Capacity	Qty/Pack
CON244300	Cello Prevail Pants Small	510 - 860 mm	1000 ml	22
CON244400	Cello Prevail Pants Medium	810 - 1120 mm	1000 ml	20
CON244500	Cello Prevail Pants Large	1140 - 1480 mm	1000 ml	18

Code	Description	Capacity	Qty/Pack
CON240000	Cello Form Pads Large	2400 ml	20
CON240100	Cello Form Pads Medium	2550 ml	20
CON240700	Cello Anaform Petite	200 ml	20
CON240800	Cello Anaform Midi	400 ml	20
CON241100	Cello Anaform EcoMidi	450 ml	20
CON241200	Insert Booster Pad 400	up to 400 ml	



TENA Slip

- Specially designed for those care recipients with greater needs and who could be either bed-ridden or over-active
- All-in-One product and features contoured, elasticized edges that ensure maximum security and comfort



TENA Pads Comfort

- Provides an excellent level of security, comfort and discretion
- Best suited to ambulant people or those who are able to toilet themselves
- To be used in conjunction with TENA Fix Stretch Pants or TENA Fix Cotton Special as part of a two-piece system

Code	Description	Waist	Capacity	Qty/Pack
CON242000	TENA Slip Extra Small	490 - 740 mm	1410 ml	30
CON242300	TENA Slip Maxi Large	1000 - 1500 mm	2300 ml	8
CON242200	TENA Slip Maxi Medium	700 - 1100 mm	2000 ml	8
CON242100	TENA Slip Maxi Small	500 - 800 mm	1200 ml	22
CON242600	TENA Slip Plus Large	1000 - 1500 mm	1500 ml	12
CON242500	TENA Slip Plus Medium	700 - 1100 mm	1300 ml	12
CON242400	TENA Slip Plus Small	500 - 800 mm	850 ml	30
CON242900	TENA Slip Super Large	1000 - 1500 mm	1800 ml	10
CON242800	TENA Slip Super Medium	700 - 1100 mm	1600 ml	10
CON242700	TENA Slip Super Small	500 - 800 mm	950 ml	25
CON248100	TENA Slip Plus Large	1000 - 1500 mm	1500 ml	20

Code	Description	Capacity	Qty/Pack
CON243000	TENA Pads Comfort Plus	780 ml	20
CON243100	TENA Pads Comfort Extra	1080 ml	20
CON243200	TENA Pads Comfort Maxi	1320 ml	20
CON243300	TENA Pads Comfort Super	1560 ml	20



TENA Pad Lady

- Features a special absorption technology with super-absorbent granules that quickly absorb and retain wetness
- Odour Control(TM) prevents odour

Code	Description	Capacity	Qty/Pack
CON243400	TENA Pad Lady Extra	295 ml	20
CON243450	TENA Pad Lady Extra Plus	350 ml	8
CON243500	TENA Pad Lady Super	515 ml	30



TENA Pad for Men Level 1

- Smaller product: Only 5 mm thick to provide a discreet anatomic shape specially designed for men
- Adhesive strip holds the pad in place in underwear
- Odour Control™ neutralises odours for all day freshness & discretion
- Textile-like backing for natural comfort
- Leak-proof backing prevents staining and has a textile feel for natural comfort



TENA Pads for Men Level 2

- Discreet Anatomic shape specially designed for men, offering security for moderate urine loss
- Adhesive strip holds the pad in place in underwear
- Odour Control™ neutralises odours for all day freshness & discretion
- Textile-like backing for natural comfort
- Leak-proof backing prevents staining and has a textile feel for natural comfort

Code	Description	Qty/Pack
CON244200	TENA Pad for Men Level 1	10

Code	Description	Qty/Pack
CON250000	TENA Pads for Men Level 2	10



TENA Active Long Liner

- Ideal when experiencing slight urine loss
- QuickDry Topsheet provides quick absorption and locks the liquid away giving superior dryness
- Odour Control™ neutralises odours for all day freshness and discretion
- Cotton-like surface next to your body
- Body shape for excellent body fit



TENA Super Shields

- Lightweight economical pad for those with minor faecal incontinence or very light urinary incontinence
- Body-shaped pad provides a snug fit
- Adhesive strips hold the pad securely in place

Code	Description	Qty/Pack
CON244250	TENA Active Long	22

Code	Description	Qty/Pack
CON248000	TENA Super Shields	30



TENA Pads Lady

- QuickDry Topsheet provides quick absorption and locks the liquid away giving superior dryness
- Scented Odour Control™ reduces the risk of odour for freshness and discretion
- Aloe Vera soft sides for extra comfort and freshness
- Cotton-like surface next to your body
- Body shape for excellent body fit



TENA Pads Flex

- FeelDry™ gives outstanding dryness, through quick inlet absorption and excellent retention
- Waist belt for easier handling for all body shapes
- Breathable backsheets™ lets the air circulate, improving user comfort and reducing skin problems

Code	Description	Qty/Pack
CON251000	TENA Pads Lady Mini Ultrathin	20
CON251200	TENA Pads Lady Mini Plus	16
CON251400	TENA Pads Lady Normal	24

Code	Description	Qty/Pack
CON249600	TENA Pads Flex Super Medium	28
CON249960	TENA Pads Flex Maxi Extra Large	21
CON249900	TENA Pads Flex Maxi Large	22
CON249800	TENA Pads Flex Maxi Medium	22
CON249700	TENA Pads Flex Super Large	28



TENA Pants Mesh Fix

- Male and female reusable stretch mesh pants made from textured nylon and lycra yarns
- They have soft elasticised waist and leg bands
- Each size has a colour coded waist band
- These pants are designed to hold disposable incontinence pads securely in position



TENA Pants Fix Cotton

- Soft cotton knit ensures a comfortable wear
- Pant gusset designed to hold pad securely as it expands
- Durable, resisting tearing and shrinkage
- Close body fit offers greater leakage security
- Longer leg enhances comfort and fit

Code	Description	Qty/Pack
CON250100	TENA Pants Mesh Fix Small	25
CON250400	TENA Pants Mesh Fix Large	25
CON250200	TENA Pants Mesh Fix Medium	25
CON250500	TENA Pants Mesh Fix X-Large	25
CON250600	TENA Pants Mesh Fix XX-Large	25

Code	Description	Qty/Pack
CON250700	TENA Pants Fix Cotton Small/Medium (Pkt 1)	1
CON250800	TENA Pants Fix Cotton Large/XL (Pkt 1)	1



LILLE Pads Supreme Fit

- Special double pad acquisition layer- maximising absorbency where it is most needed in the central area
- Time/wetness indicator strip which changes colour when the pad is wet
- Contain super absorbent – maximising absorbency and odour neutralisation



LILLE Classic Line

- Pads can be used in main area as a traditional incontinence product, worn with pouch pant

Code	Description	Qty/Pack
CON259350	LILLE Pads Supreme Fit Maxi Small	20
CON259400	LILLE Pads Supreme Fit Maxi Medium	20
CON259500	LILLE Pads Supreme Fit Maxi Large	20
CON259600	LILLE Pads Supreme Fit Maxi Extra Large	20

Code	Description	Qty/Pack
CON259910	LILLE Classic Line Maxi	28



LILLE Pad Super Insert

- Cost effective way to boost the capacity of another pad
- Free from any plastic backing
- Can also be used to protect a main pad from faecal smearing

Code	Description	Qty/Pack
CON259980	LILLE Pad Super Insert	30
LCLN1111-02	LILLE Pad Mini Insert	28

Clothing Protectors - Reusable



Briefs Safety

- Designed to provide females with piece of mind, whilst being comfortable and discreet



Briefs Confident

- Unisex, re-usable, absorbent and the soft stay-dry surface reduces skin irritation

Code	Description	Size	Hip Measurement	Capacity
CON233600	Briefs Safety Sml	12	900 mm	150 - 200 ml
CON233700	Briefs Safety Med	14	950 mm	150 - 200 ml
CON233800	Briefs Safety Lrg	16	1000 mm	150 - 200 ml
CON233900	Briefs Safety XL	18	1050 mm	150 - 200 ml
CON234000	Briefs Safety XXL	20	1100 mm	150 - 200 ml

Code	Description	Size	Hip Measurement	Capacity
CON232900	Briefs Confident Sml	12	750 - 800 mm	300 - 330 ml
CON232800	Briefs Confident Med	14	850 - 900 mm	300 - 330 ml
CON232700	Briefs Confident Lrg	16	950 - 1000 mm	300 - 330 ml
CON233000	Briefs Confident XL	18	1050 - 1100 mm	300 - 330 ml
CON233200	Briefs Confident XXL	20	1150 - 1200 mm	300 - 330 ml



Insert Pads Womans

- Specifically shaped for women, supplied in a twin pack with a convenient waterproof zip bag
- Designed for light incontinence (180 mls over 4 hrs)



Insert Pads Mens

- Soft micro-fibre lining rapidly absorbs and feels dryer, flexible PUL waterproof is cool and comfortable with an elastic clip strap for secure application
- Specifically shaped for men, supplied in a twin pack with a convenient waterproof zip bag
- Designed for light incontinence (up to 250 mls over 4 hrs)

Code	Description	Length	Code	Description	Length
CCD-WOMINS-1	Insert Pads Womans	260 mm	CCD-MENINS-1	Insert Pads Mens	380 mm



Ladies Classic Undergarment

- The waistline sits comfortably on the hips and the leg opening is a medium cut
- Designed for light incontinence (350 mls in a 4 hour period)
- Absorbent to the waistband both front and back for extra security, and features waterproof, breathable PUL so the user will not become hot or clammy
- Colours available in Pink, Beige and Black



Ladies Chantilly Undergarment

- Constructed from cotton elastane and features pretty stretch lace in front of the leg opening
- The waistline sits comfortably just above the hips with a slightly lower cut leg
- Designed for light incontinence (350 mls in a 4 hour period)
- Colours available in Pink, Beige and Black

Code	Description	Size	Code	Description	Size
5602-size 10 - 20	Ladies Classic Undergarment	10 - 20	5601-size 10 - 20	Ladies Chantilly Undergarment	10 - 20
5602-size 22 - 26	Ladies Classic Undergarment	22, 24 & 26	5601-size 22 - 26	Ladies Chantilly Undergarment	22, 24 & 26



Ladies Active Undergarment

- Designed for the active woman who needs only light protection
- This brief is fashionably styled in cotton elastane, with a semi boy leg and generous hipster fit
- The in built absorbent panty pad will hold 125 mls over a 4 hour period
- Colours available: Pink (all sizes), Beige (up to size 20) and Black (up to size 20)

Code	Description	Size
5603-size 10 - 20	Ladies Active Undergarment	10 - 20
5603-size 22 - 26	Ladies Active Undergarment	22, 24 & 26



Mens Oscar Undergarment

- Made from cotton elastane with a heavy-duty elastic waist band
- Designed for light incontinence (350 mls in a 4 hour period)
- Colours available in Grey and Black



Mens Kalven Undergarment

- Made from cotton elastane, with a front opening and heavy duty elastic waist band. Designed for light incontinence (350 mls in a 4 hour period)
- Perfect for use after prostate surgery, the undergarment provides the support needed during the post-operative phase
- Colours available in Grey and Black

Code	Description	Code	Description
5702	Mens Oscar Undergarment	5701	Mens Kalven Undergarment

Aidacare Online

For all of your product enquiries in one user-friendly site visit us online at www.aidacare.com.au

- New product releases - updated daily
- Clear and concise product descriptions and specifications
- Contract specific ordering information (DVA, TAC & MASS)
- Downloadable DVA RAP and other order forms
- Full colour product images
- Information on our range of service offerings
- Newsletter subscription page

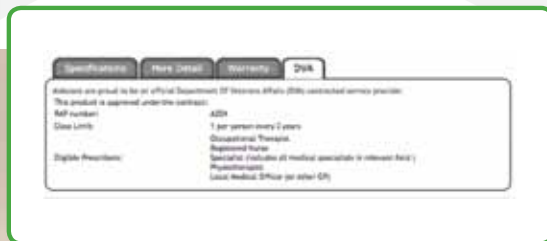

"We care for your care"



Daily Living Aids



- P 117** Dressing Aids
- P 119** Kitchen Aids
- P 120** Gripping & Turning Aids
- P 122** Cutlery
- P 126** Crockery
- P 128** Reaching Aids
- P 129** General Household Aids



EzyAs Compression Stocking Applicator

- Unique plastic gutter to assist in pulling on compression stockings
- Stocking is fed onto gutter, held in place by side notches, slipped over foot, then pulled into place

DVA For eligibility & prescriber info please refer to pg 7.

Code	Model	Calf/Arm Circ.	Length	Width	RAP #:
DLD269001	Small	280-350 mm	140 mm	140 mm	AU13
DLD269002	Med	320-400 mm	140 mm	140 mm	AU13
DLD269003	Large	380-470 mm	175 mm	140 mm	AU13
DLD269004	Handle	-	270 mm	210 mm	AU13



Stocking Aid

- Lightweight plastic gutter assists changing into and out of compression stockings
- Designed for those who have difficult bending, reaching or grabbing
- Stocking is fed onto gutter, held in place by side notches, slipped over foot, then pulled into place

DVA For eligibility & prescriber info please refer to pg 7.

Code	Description	Cord Len.	Gutter Len.	Product Wt.	RAP #:
DLD269270	Stocking Aid	920 mm	229 mm	55 g	AU13



Stocking Aid - Dorking

- A simple, inexpensive device to assist with putting on a stocking or sock especially if bending and reaching to the foot is difficult
- It consists of a strong, shaped, flexible plastic gutter with long cotton tapes attached to the top

DVA For eligibility & prescriber info please refer to pg 7.

Code	Description	RAP #:
DLD269260	Stocking Aid - Dorking	AU13



Terry Cloth Sock Aid

- Lightweight and comfortable heel contour assists changing into and out of socks
- Slits allow flexibility around the heel for best fit and two pulling tabs with loop handles permit one-handed application



Sock Aid

- Lightweight plastic gutter assists changing into and out of socks
- Sock is fed onto gutter, slipped over foot, then pulled into place

DVA For eligibility & prescriber info please refer to pg 7.

Code	Description	Gutter Length	Width	RAP #:
DLD269090	Terry Cloth Sock Aid	230 mm	125 mm	AU13
DLD269275	Sock Aid	230 mm	130 mm	AU13



Easy-Slide - applicator for open-toe stockings

- Application aid for open-toe stockings
- Also suitable for hospital stockings with inspection hole
- Slide stocking over, and then remove through open toe
- Suggest to use with rubber gloves

Code	Size	Shoe Size	Suit Foot
ES10	Small	34-37	Child / woman's small
ES20	Medium	38-41	Woman's medium / men's small
ES30	Large	42-45	Woman's large / men's medium
ES40	X-large	46+	Men's large



Easy-Slide-Caran - applicator for closed-toe stockings

- Application aid for closed-toe garments
- Slide stockings over, then remove from top of stocking
- Suggest to use with rubber gloves

Code	Size	Shoe Size
ES95	Small / Med	Up to 38
ES100	Medium / Lge	Over 38



Shoe Horn

- Long handled plastic shoe horn to assist in putting on shoes
- Designed for those who have difficult bending, reaching or grabbing
- Plastic hanging loop attached to handle

DVA For eligibility & prescriber info please refer to pg 7.

Code	Description	Length	Product Weight	RAP #:
DLD269160	Shoe Horn	430 mm	37 g	AH19



Metal Shoe Horn

- Long handled metal shoe horn to assist in putting on shoes
- Designed for those who have difficult bending, reaching or grabbing
- Plastic hanging loop attached to PVC coated handle

DVA For eligibility & prescriber info please refer to pg 7.

Code	Description	Length	Product Weight	RAP #:
DLD269170	Metal Shoe Horn	600 mm	233 g	AH19



Dressing Stick

- Lightweight wooden stick with hook assists changing into and out of garments
- Designed for those who have difficult bending, reaching or grabbing

DVA For eligibility & prescriber info please refer to pg 7.

Code	Description	Length	Product Wt.	RAP #:
DLD269310	Dressing Stick	520 mm	230 g	AU04

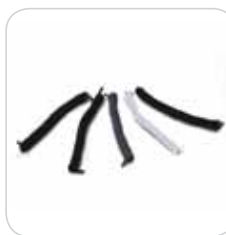

Spring Laces

- Elasticised and spring coiled shoe laces convert lace-up shoes into slip-on shoes
- Laces fasten by wrapping the ends together so do not need to be tied into a bow

DVA For eligibility & prescriber info please refer to pg 7.

Code	Description	RAP #:
DLD269140	Spring Laces Black 600 mm	AU14
DLD269150	Spring Laces White 600 mm	
DLD269151	Spring Laces Brown 600 mm	
DLD269153	Spring Laces Blue 600 mm	



Soesi Laces

- Elasticised shoe laces convert lace-up shoes into slip-on shoes
- Ideal for those who have trouble reaching or tying their shoes
- Supplied in pairs

DVA For eligibility & prescriber info please refer to pg 7.

Code	Description	RAP #:
DLD269190	Soesi Laces Brown 450 mm (3 pairs)	AU14
DLD269200	Soesi Laces Black 450 mm (3 pairs)	AU14
DLD269220	Soesi Laces Brown 610 mm (2 pairs)	AU14
DLD269230	Soesi Laces Black 610 mm (2 pairs)	AU14

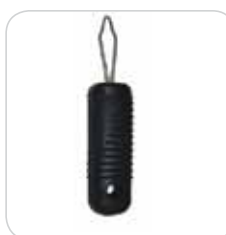

Button Hook Supergrip

- Assists one handed dressing
- Shaped stainless steel wire with large plastic handle ideal for those lacking fine motor coordination
- Pass through the button hole and over the button to grip the thread

DVA For eligibility & prescriber info please refer to pg 7.

Code	Description	Handle Diameter	RAP #:
DLD269050	Button Hook Supergrip	40 mm	AU02



Button Hook Kings

- Assists one handed dressing
- Pass through the button hole and over the button to grip the thread
- Button pulled through with twisting motion
- Shaped stainless steel wire with plastic handle

DVA For eligibility & prescriber info please refer to pg 7.

Code	Description	Len. Wire	Len. Handle	Product Wt.	RAP #:
DLD269300	Button Hook Kings	97 mm	120 mm	75 g	AU02



Leg Lifter

- Enables the user to move a stiff or immobile leg
- Upper loop fits around the hand and wrist and the lower stiffened loop slides over the foot to give control when lifting the leg
- Stiffened stem assists with manoeuvring leg
- Ideal assistance for getting into or out of a bed, wheelchair or using a footstool etc

DVA For eligibility & prescriber info please refer to pg 7.

Code	Description	Length	Product Weight	RAP #:
DLD269390	Leg Lifter	864 mm	80 g	AP09



Long Handled Comb/Brush

- Comb or brush with long handle attached
- Designed for those have difficulty raising, bending or reaching their arms
- Lightweight moulded plastic handle with a push-on extension piece that is easily removed

DVA For eligibility & prescriber info please refer to pg 7.

Code	Description	Length	Length Folded	Product Weight	RAP #:
DLD269330	Long Handled Fine Comb	460 mm	235 mm	120 g	AU08
DLD269340	Long Handled Comb	460 mm	235 mm	114 g	AU08
DLD269350	Long Handled Brush	460 mm	235 mm	128 g	AU08



Nail Care Combination Set

- This two-in-one aid for fingernail care is designed for people who cannot grasp or use small hand-held implements
- Mounted onto a plastic base with non-slip feet, the stainless steel trimmer clips nails with a simple push of the lever. An emery board is held rigidly in a spring clip for one-handed filing. Two emery boards included.

Code	Description
DLD269360	Nail Care Combination Set



Trolley Wooden Trays

- This Kitchen Trolley is fully portable mounted on four swivel castors, featuring a two shelf system, ideal for meal serving or as a bedside item

DVA For eligibility & prescriber info please refer to pg 7.

Code	Description	Tray Dimension	Height	Product Weight	RAP #:
DLG272050	Trolley with Wooden Trays	450 x 450 mm	900 mm	9.6 kg	AH14



Trolley Plastic Trays

- Ideal for use in the house, this mobile kitchen trolley gives greater independence for the user and features removable plastic trays.
- Height adjustable frame

DVA For eligibility & prescriber info please refer to pg 7.

Code	Description	Tray Dimension	Height	Product Weight	RAP #:
DLG272060	Trolley with Plastic Trays	280 x 440 mm	820 - 1120 mm	5 kg	AH14



Good Grips Can Opener

- Easy to use can opener with soft, comfortable non slip grip

DVA For eligibility & prescriber info please refer to pg 7.

Code	Description	Dimensions	Product Wt.	RAP #:
DLK275090	Good Grips Can Opener	177 x 50 x 76 mm	255 g	AH07



Good Grips Peelers

- Easy to use peelers with soft, comfortable non slip grip featuring a precision ground stainless steel blade for a sharper cutting edge

DVA For eligibility & prescriber info please refer to pg 7.

Code	Description	Dimensions	Product Wt.	RAP #:
DLK275100	Y Peeler	152 x 76 x 25 mm	56 g	AH07
DLK275110	Swivel Peeler	177 x 25 x 25 mm	56 g	AH07



Good Grips Jar Opener

- Easy to use jar opener with soft, comfortable non slip grip features stainless steel teeth allowing safe opening of any jar

DVA For eligibility & prescriber info please refer to pg 7.

Code	Description	Dimensions	Product Wt.	RAP #:
DLK275120	Good Grips Jar Opener	228 x 127 x 25 mm	113 g	AH07



Ring-Pull Tin Opener

- A plastic ring puller that provides excellent leverage and has a large broad surface for grip
- The flat end fits easily under the tab to break the seal prior to levering the lid off with the hook end

DVA For eligibility & prescriber info please refer to pg 7.

Code	Description	RAP #:
DLK275600	Ring-Pull Opener	AH07



Can Opener Pull

- The Canpull is a durable device especially designed for opening ring pull cans
- Extremely easy to use, just hook the end under the ring, fold forwards and then roll back. Suitable for users either with arthritis or with a weak grip

DVA For eligibility & prescriber info please refer to pg 7.

Code	Description	RAP #:
DLK275610	Can Opener Pull	AH07



Kitchen Workstation

- This multifunction food preparation unit is designed to provide assistance with many day to day kitchen tasks

DVA For eligibility & prescriber info please refer to pg 7.

Code	Description	Product Weight	RAP #:
DLK275700	Kitchen Workstation	1.6 kg	AH01



Bread Board Wooden

- This hardwood board is ideal for cutting one-handed, it features non-slip feet, six stainless steel spikes to grip bread or vegetables

DVA For eligibility & prescriber info please refer to pg 7.

Code	Description	Dimensions	Product Wt.	RAP #:
DLK275710	Bread Board Wooden	325 x 175 mm	972 g	AH15



Food Preparation System

- This durable cutting board is ideal for those who have difficulty in gripping, or only have the use of one hand
- Suits various food prep cutting tasks

DVA For eligibility & prescriber info please refer to pg 7.

Code	Description	Dimensions	Product Wt.	RAP #:
DLK275720	Food Preparation System	315 x 295 mm	1.66 kg	AH15



Plastic Spread Board

- This durable one-piece board allows bread to be spread using one hand with a raised "L" shape in one corner

DVA For eligibility & prescriber info please refer to pg 7.

Code	Description	Dimensions	Product Wt.	RAP #:
DLK275730	Plastic Spread Board	181 x 256 mm	190 g	AH01



Kettle Tipper

- A raised tilting platform, designed to assist with pouring from any standard kettle with virtually no effort or risk of spilling boiling water

DVA For eligibility & prescriber info please refer to pg 7.

Code	Description	Platform Height	Product Wt.	RAP #:
DLK276600	Kettle Tipper	93 mm	1 kg	AH17



Cordless Kettle Tipper

- This innovative kettle tipper will suit most cordless kettles
- There is a metal plate that secures the base of the cordless kettle and a frame with a hook and loop strap to keep the upper part of the kettle in place

DVA For eligibility & prescriber info please refer to pg 7.

Code	Description	RAP #:
DLK276610	Cordless Kettle Tipper	AH17



Jug Kettle Tipper

- A coated wire cradle that holds most styles of jug kettle, and pivots on a raised wire frame by gentle pressure on the handle to assist with pouring
- Not suitable for cordless or mini jug kettles

DVA For eligibility & prescriber info please refer to pg 7.

Code	Description	Product Weight	RAP #:
DLK276620	Jug Kettle Tipper	602 g	AH17



Moulded Lap Tray

- Durable and lightweight tray with a moulded rim and recessed area for cup or glass
- Includes two D-Ring hook and loop straps for secure attachment
- Dimensions: 600 x 500mm. Recessed area 370 x 230mm
- Colours may vary slightly

DVA For eligibility & prescriber info please refer to pg 7.

Code	Description	Product Weight
DLK277000	Moulded Lap Tray	1.6 kg

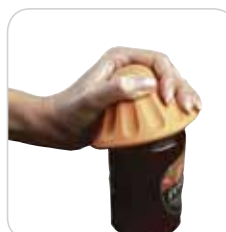

Twister Jar Opener

- Gives a good grip for opening twist off jar lids
- Cone shaped rubber moulding with fluted finger grips on the outside and ribbing on the inside

DVA For eligibility & prescriber info please refer to pg 7.

Code	Description	Product Weight	RAP #:
DLK275520	Twister Jar Opener	100 g	AH07



Undo-it Jar Opener

- A V-shaped coated metal opener with non-slip lining that is screwed underneath a shelf or cupboard. The jar is slid into the V until the lid wedges. It is then twisted to remove the lid. Suitable for tops 25 to 75mm (1 to 3") diameter

DVA For eligibility & prescriber info please refer to pg 7.

Code	Description	Product Weight	RAP #:
DLK275530	Undo-it Jar Opener	145 g	AH07



Strongboy Opener

- Assists opening a variety of diameter twist off jar lids
- flexible stainless steel band is fitted around a lid, and then clamped tight using the screw at the end of the handle

DVA For eligibility & prescriber info please refer to pg 7.

Code	Description	Product Weight	RAP #:
DLK275550	Strongboy Opener	88 g	AH07



Bottle Holder - Belliclamp

- This device hooks over the edge of a worktop and the jar or bottle is then placed in the V
- The object is clamped by the ram, which can be pushed with the stomach or hip, leaving hands free to twist the top

DVA For eligibility & prescriber info please refer to pg 7.

Code	Description	RAP #:
DLK275580	Bottle Holder - Belliclamp	AH07



Multi Holder

- Comfortable, easily adjustable, strap handle that provides a secure grasp on a variety of handle shapes and sizes
- Securely holds a range of items

DVA For eligibility & prescriber info please refer to pg 7.

Code	Description	RAP #:
DLK276430	Multi Holder	AH01



Great Grips Red/Blue

- Great Grips are soft covers that enable you to grip and twist door knobs or round faucets with less effort

DVA For eligibility & prescriber info please refer to pg 7.

Code	Description	RAP #:
DLG271100	Great Grips Clear	AH13
DLG271110	Great Grips Glow (glow in the dark)	AH13
DLG271120	Great Grips Red/Blue (hot & cold taps)	AH13



Utensil Holder Small

- For those with poor hand function or a weak grip has a half cone shaped plastic base, which angles the utensil away from the palm to make eating pattern easier

DVA For eligibility & prescriber info please refer to pg 7.

Code	Description	RAP #:
DLG271180	Utensil Holder Small	A01



Foam Tubes

- Provide a built-up handle for easier gripping

DVA For eligibility & prescriber info please refer to pg 7.

Code	Description	External Diameter	Internal Diameter	Length	RAP #:
DLG271270	Foam Tube Grey	31 mm	12 mm	1 metre	AH17
DLG271230	Foam Tube Grey	31 mm	6 mm	1 metre	AH17
DLG271250	Foam Tube Grey	31 mm	9 mm	1 metre	AH17
DLG271260	Foam Tube White	31 mm	12 mm	1 metre	AH17
DLG271210	Foam Tube White	19 mm	6 mm	1 metre	AH17
DLG271220	Foam Tube White	31 mm	6 mm	1 metre	AH17



Tap Turners

- Provides leverage to assist turning taps on and off
- Moulded plastic turner fits over the X shaped tap head
- Supplied as 1 red and 1 blue to be used with hot and cold taps

DVA For eligibility & prescriber info please refer to pg 7.

Code	Description	Length	Product Wt.	RAP #:
DLG271280	Tap Turners , Pair	140 mm	65 g	AH13



Tap Turner Crystal

- Provides leverage to assist turning taps on and off
- Clamps onto cylindrical taps up to 6cm in diameter

DVA For eligibility & prescriber info please refer to pg 7.

Code	Description	Len. Closed	Product Wt.	RAP #:
DLG271290	Tap Turner Crystal, Each	190 mm	112 g	AH13



Tap Turner - Contour

- This device is used to give good leverage for turning small difficult items eg. gas or radiator taps

DVA For eligibility & prescriber info please refer to pg 7.

Code	Description	RAP #:
DLG271300	Tap Turner - Contour	AH13

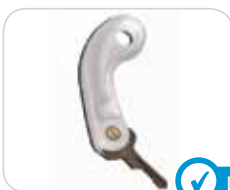

Key Turner

- This heavy duty Key Turner provides a curved built-up handle for comfortable grip and increases leverage while turning a key

DVA For eligibility & prescriber info please refer to pg 7.

Code	Description	Product Wt.	RAP #:
DLG271310	Key Turner White	40 g	AH08
DLG271320	Key Turner 2 (holds two keys) Blue	70 g	AH08



Dycem Anchor Pad

- This product is made out of Dycem, an effective non-slip material

DVA For eligibility & prescriber info please refer to pg 7.

Code	Description	Dimensions	RAP #:
DLG271380	Dycem Anchor Pad Round	190 mm	AH09
DLG271390	Dycem Anchor Pad Small	250 x 180 mm	AH09
DLG271400	Dycem Anchor Pad Large	350 x 250 mm	AH09
DLG271410	Dycem Anchor Activity Anchorpad	450 x 380 mm	AH09



Grippimat Reel

- Grippimats are thinner and more flexible than the moulded ones, therefore they can be wrapped around items e.g. jar tops

DVA For eligibility & prescriber info please refer to pg 7.

Code	Description	Dimensions	RAP #:
DLG271450	Grippimat Reel Blue 200 x 2	200 mm x 2 m	AH09
DLG271460	Grippimat Reel Blue 200 x 9	200 mm x 9 m	AH09
DLG271480	Grippimat Reel Blue 400 x 2	400 mm x 2 m	AH09
DLG271490	Grippimat Reel Blue 400 x 9	400 mm x 9 m	AH09



Pen Holder

- The Pen Holder has been designed to make the pen easier to grip and control, made from soft PVC it slides over normal sized pens and pencils
- Sold as a set of three

Code	Description	RAP #:
DLG271520	Pen Holder	



Supergrip Cutlery

- The Supergrip Cutlery is a comfortable, wide, built-up ribbed handled utensil set ideal for users with limited hand function
- Stainless steel, dishwasher safe

DVA For eligibility & prescriber info please refer to pg 7.

Code	Description	Handle Length	Handle Width	Weight	RAP #:
DLK275310	Supergrip Teaspoon	102 mm	38 mm	45 g	AH01
DLK275320	Supergrip Tablespoon	102 mm	38 mm	55 g	AH01
DLK275330	Supergrip Fork	102 mm	38 mm	45 g	AH01
DLK275340	Supergrip Knife	102 mm	38 mm	55 g	AH01
DLK275350	Supergrip Set of 4	102 mm	38 mm	N/A	AH01



Supergrip Bendable Cutlery

- The Supergrip Bendable Cutlery is designed to be bent into any angle to accommodate reduced range of motion
- The spoons and fork feature a metal shaft that is easily bent to any angle to accommodate reduced range of motion and to provide the greatest comfort for the user

DVA For eligibility & prescriber info please refer to pg 7.

Code	Description	Length	Weight	RAP #:
DLK275360	Supergrip Bendable Teaspoon	180 mm	45 g	AH01
DLK275370	Supergrip Bendable Tablespoon	200 mm	55 g	AH01
DLK275380	Supergrip Bendable Fork	205 mm	45 g	AH01
DLK275390	Supergrip Bendable Knife	210 mm	55 g	AH01

- The rocker knife cuts with a minimum of motion. They have comfortable rubber built-up handles and stainless steel utensils.
- Dishwasher safe.

Please note: Picture shows Supergrip Bendable Fork.



Sofftouch Cutlery

- Plastic coated spoons that provide protection for teeth and lips from utensil edges and temperature sensitivity
- Not recommended for those with heavy biting reflexes

DVA For eligibility & prescriber info please refer to pg 7.

Code	Description	RAP #:
DLK275410	Sofftouch Teaspoon	AH01
DLK275430	Sofftouch Youth Spoon (A70373)	AH01



Reflex Cutlery

- The Reflex range has easy-to-grip contoured handles for people with a weak grip and limited arm power
- The blades are also set at an angle from the handle to minimise wrist movement. Dishwasher safe

DVA For eligibility & prescriber info please refer to pg 7.

Code	Description	Blade Length	Product Weight	RAP #:
DLK275650	Reflex Preparation Knife	127 mm	140 g	AH01
DLK275690	Reflex Carving Fork	156 mm	140 g	AH01
DLK275660	Reflex Carving Knife	203 mm	155 g	AH01
DLK275670	Reflex Chef Knife	203 mm	165 g	AH01
DLK275680	Reflex Slicing Knife	254 mm	125 g	AH01



Queens Splayed Cutlery

- The Queens Splayed Fork has an edge designed for cutting food and can be used as a fork for one hand eating
- The Queens Nelson Knife is also designed for one hand eating, but features a steel knife blade that can be used with a rocker action and the pronged end as a fork

DVA For eligibility & prescriber info please refer to pg 7.

Code	Description	Handle Length	Handle Diameter	Product Weight	RAP #:
DLK275800	Queens Splayed Fork	98 mm	30 mm	45 g	AH01
DLK275810	Queens Nelson Knife	98 mm	30 mm	45 g	AH01



Queens Angled Cutlery

- A range of stainless steel utensils with an angled head mounted in the Queens built-up handle, enabling those with limited wrist movement to eat more easily
- The knife has a blade bent at an angle to the handle and can be used with a rocker action
- The fork and spoon are available as right or left handed versions

DVA For eligibility & prescriber info please refer to pg 7.

Code	Description	Handle Len.	Handle Diameter	Product Wt.	RAP #:
DLK275820	Queens Angled Knife	98 mm	30 mm	45 g	AH01
DLK275830	Queens LH Angled Fork	98 mm	30 mm	55 g	AH01
DLK275840	Queens RH Angled Fork	98 mm	30 mm	55 g	AH01
DLK275850	Queens LH Angled Spoon	98 mm	30 mm	55 g	AH01
DLK275860	Queens RH Angled Spoon	98 mm	30 mm	55 g	AH01



Queens Cutlery

- A wide range of stainless steel utensils mounted into a built-up plastic handle to help those with weak or restricted grip, the handle is cylindrical to assist with gripping
- The items are hygienically sealed, easy to clean and are dishwasher safe

DVA For eligibility & prescriber info please refer to pg 7.

Code	Description	Handle Len.	Handle Diameter	Product Wt.	RAP #:
DLK275870	Queens Cutlery Set	98 mm	30 mm	45 g	AH01
DLK275760	Queens Cutlery Knife	98 mm	30 mm	45 g	AH01
DLK275770	Queens Cutlery Fork	98 mm	30 mm	45 g	AH01
DLK275780	Queens Cutlery Spoon	98 mm	30 mm	45 g	AH01
DLK275790	Queens Cutlery Junior Spoon	98 mm	30 mm	45 g	AH01



Kings Softcoated Head Spoon

- The Softcoated range has been dipped in soft, food quality white PVC making the spoons ideal for users with a bite reflex problem when eating
- Due to the type of use to which these items are subjected, they are only guaranteed for 3 months

DVA For eligibility & prescriber info please refer to pg 7.

Code	Description	Length	Product Wt.	RAP #:
DLK275880	Kings Spoon Softcoated Head	100 mm	32 g	AH01
DLK275890	Kings Teaspoon Softcoated Head	80 mm	25 g	AH01



Kings Modular Cutlery

- The Kings Modular Cutlery is mounted in a plastic spigot that pushes tightly into your chosen handle, but allow the blade to be angled as desired

DVA For eligibility & prescriber info please refer to pg 7.

Code	Description	Length	Product Wt.	RAP #:
DLK275900	Kings Knife Std Head	112 mm	17 g	AH01
DLK275910	Kings Fork Std Head	104 mm	21 g	AH01
DLK275970	Kings Nelson Knife Std Head		25 g	AH01
DLK276040	Kings Rocker Knife Large Std Head		45 g	AH01
DLK275980	Kings Rocker Knife Small Std Head		19 g	AH01
DLK275960	Kings Splayed Kit (Knife, Fork, Spoon)		N/A	AH01
DLK275930	Kings Junior Spoon	91 mm	21 g	AH01
DLK275920	Kings Spoon Std Head	104 mm	21 g	AH01
DLK275940	Kings Teaspoon	84 mm	17 g	AH01
DLK275950	Kings Soup Spoon	112 mm	26 g	AH01



Kings Handles

- The Kings Handle range are designed for use with the Kings Modular and Kings Angled Cutlery range
- The Standard has a hollow cylindrical body. The Slim has an oval cross-section. The Contoured has a curved shape and finger contours

DVA For eligibility & prescriber info please refer to pg 7.

Code	Description	Width	Product Wt.	RAP #:
DLK276070	Kings Handle	25 mm	30 g	AH06
DLK276060	Kings Contour Handle	22 - 30 mm	85 g	AH06
DLK276100	Kings Heavy Handle	25 mm	156 g	AH06
DLK276120	Kings Slim Handle	14 - 19 mm	29 g	AH06

- The heavy handle has a hollow core filled with a non-toxic metal bar to create a heavier handle. Ideal for people with tremors

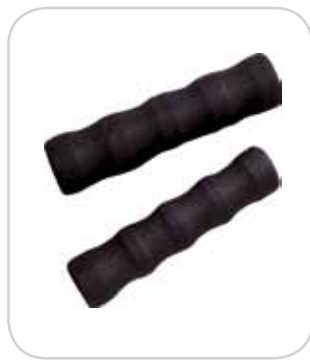

Kings Lightweight Handles

- Ideal for people who require a lightweight, built up handle
- These sculptured closed-cell foam handles are waterproof, washable and feature contoured finger grips

DVA For eligibility & prescriber info please refer to pg 7.

Code	Description	Width	Product Weight	RAP #:
DLK276090	Kings Lightweight Handle Small	20 mm	10 g	AH06
DLK276080	Kings Lightweight Handle Large	28 mm	12 g	AH06

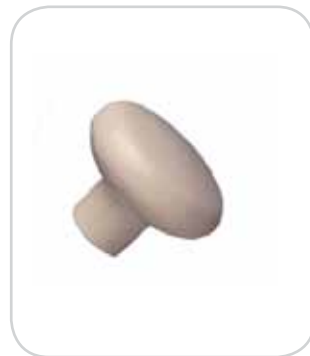

Kings Mushroom Handle

- The Mushroom is a round hollow doorknob type handle which is easy to grip for those with weak or painful joints

DVA For eligibility & prescriber info please refer to pg 7.

Code	Description	RAP #:
DLK276130	Kings Mushroom Handle	AH06



Kings Built Up Sleeves

- Contoured PVC sleeves fit onto the Kings Slim Handle (DLK276120)
- The oval sleeve is oval in shape in both dimensions whilst the small and large are contoured with finger grips
- These built up sleeves provide a larger grip for the user

DVA For eligibility & prescriber info please refer to pg 7.

Code	Description	Width	Product Weight	RAP #:
DLK276140	Kings Oval Built Up Sleeve	23 - 30 mm	24 g	AH06
DLK276160	Kings Large Built Up Sleeve	29 - 35 mm	38 g	AH06
DLK276150	Kings Small Built Up Sleeve	22 mm	19 g	AH06



Kings Assessment Set

- The Kings Assessment Set is ideal for assessing individual needs
- It comes complete with one of each of 18 Kings modular utensils, a variety of handles and a sleeve to build up a handle further, a total of 32 pieces

Code	Description
DLK276170	Kings Assessment Set



Lightweight Cutlery

- These stainless steel utensils are mounted on plastic stems and sealed into light grey foam handles, to give help for those with weak or painful grip
- The foam is comfortable to hold and washable

DVA For eligibility & prescriber info please refer to pg 7.

Code	Description	Handle Len.	Diameter	Product Weight	RAP #:
DLK276220	Lightweight Cutlery Set - 3 piece	115 mm	28 mm	N/A	AH01
DLK276200	Lightweight Spoon	115 mm	28 mm	45 g	AH01
DLK276190	Lightweight Fork	115 mm	28 mm	34 g	AH01
DLK276180	Lightweight Knife	115 mm	28 mm	45 g	AH01
DLK276210	Lightweight Teaspoon	115 mm	28 mm	30 g	AH01



Lightweight Angled Knife

- Angled versions of the lightweight foam range for those with limited wrist or arm movement. The knife can be used without cocking the wrist and the fork and spoon are available as right (R) or left (L) handed versions
- Knife blade at 90° angle. Fork and spoon at 40°; angles. Stainless steel utensils with closed cell foam handles

DVA For eligibility & prescriber info please refer to pg 7.

Code	Description	Handle Len.	Diameter	Product Wt.	RAP #:
DLK276240	Lightweight Angled Fork LH	115 mm	28 mm	40 g	AH01
DLK276250	Lightweight Angled Fork RH	115 mm	28 mm	40 g	AH01
DLK276230	Lightweight Angled Knife	115 mm	28 mm	45 g	AH01
DLK276260	Lightweight Angled Spoon LH	115 mm	28 mm	46 g	AH01
DLK276270	Lightweight Angled Spoon RH	115 mm	28 mm	46 g	AH01



Caring Cutlery

- A range of stainless steel utensils moulded into contoured, ivory-coloured plastic handles with built-up ends. These are of value to those with a weak grip and restricted wrist or finger movement.
- The knife and fork have a shaped indent on the top for the index finger, to help with directional control

DVA For eligibility & prescriber info please refer to pg 7.

Code	Description	Handle Len.	Product Wt.	RAP #:
DLK276300	Caring Knife	127 mm	50 g	AH01
DLK276310	Caring Fork	127 mm	50 g	AH01
DLK276320	Caring Spoon	127 mm	60 g	AH01
DLK276330	Caring Angled Spoon Right Hand	127 mm	65 g	AH01

- The knife also has a serrated blade to assist with cutting. In addition to the standard spoon, there is a right handed angled spoon with an angled handle to minimise wrist movement.
- Hygienically sealed, easy to clean and dishwasher safe.



Caring Cutlery Junior

- A range of knife, fork and spoon similar in concept to the Caring Cutlery range, but smaller in size
- Designed primarily for children, they are easy to clean and dishwasher safe
- Stainless Steel cutlery

DVA For eligibility & prescriber info please refer to pg 7.

Code	Description	Handle Len.	Product Wt.	RAP #:
DLK276340	Caring Knife Junior	102 mm	24 g	AH01
DLK276350	Caring Fork Junior	102 mm	22 g	AH01
DLK276360	Caring Spoon Junior	102 mm	24 g	AH01



Nelson Knife

- A stainless steel knife designed for one handed eating
- The stainless steel knife blade can be used with a rocker action and the pronged end used as a fork
- A built up sleeve from the Kings Modular cutlery range may be added to the handle
- Dishwasher safe

DVA For eligibility & prescriber info please refer to pg 7.

Code	Description	Handle Length	Product Weight	RAP #:
DLK276440	Nelson Knife	100 mm	54 g	AH01



Anti Spill Mug

- A tough, clear plastic mug with a large handle
- It is supplied with two lids, one for anti-spill, and one with a drinking spout
- The mug is dishwasher-safe, but not the lid, and it can be used in a microwave oven



Caring Mug

- The Caring Mug features a wide stable base with two large contoured and angled handles
- It is designed to be held in a comfortable position for drinking and is useful for people with tremor or who cannot sit upright. The mug is microwaveable

DVA For eligibility & prescriber info please refer to pg 7.

DVA For eligibility & prescriber info please refer to pg 7.

Code	Description	Capacity	Product Wt.	RAP #:
DLK276500	Anti Spill Mug	400 ml	160 g	AH01

Code	Description	Capacity	Product Wt.	RAP #:
DLK276510	Caring Mug	300 ml	176 g	AH01



Dysphagia Cup

- Designed to assist people who have trouble swallowing, drinking while tucking the chin toward the chest gives normal swallowing mechanisms time to work
- The design of this cup helps prevent liquids from escaping at the lips and directs the liquid to the centre of the mouth



Feeding Cup Adjustable Spout

- A feeding cup with a spout that can be vertical or clicked over to an angled position for drinking when less tilt is required
- Available with 4 mm or 8 mm spout hole. Sold in pairs

DVA For eligibility & prescriber info please refer to pg 7.

DVA For eligibility & prescriber info please refer to pg 7.

Code	Description	Capacity	Product Wt.	RAP #:
DLK275470	Dysphagia Cup Green	200 ml	230 g	AH01
DLK275460	Dysphagia Cup Almond	200 ml	230 g	AH01

Code	Description	Capacity	Product Wt.	RAP #:
DLK276570	Feeding Cup with adj. 4mm spout	250 ml	60 g	AH01
DLK276580	Feeding Cup with adj. 8mm spout	250 ml	100 g	AH01



Feeding Cup

- A clear plastic beaker, designed for easy gripping, which has a vented lid with a drinking spout. Available with 4 mm or 8 mm spout hole. Supplied in pairs



Insulated Mug

- A plastic mug with double wall insulation keeping the contents hot whilst protecting the hand

DVA For eligibility & prescriber info please refer to pg 7.

DVA For eligibility & prescriber info please refer to pg 7.

Code	Description	Capacity	Product Wt.	RAP #:
DLK276550	Feeding Cup with 4 mm spout	200 ml	80 g	AH01
DLK276560	Feeding Cup with 8 mm spout	200 ml	100 g	AH01

Code	Description	RAP #:
DLK276540	Insulated Mug	AH01



Nosey Cup

- These cups are designed for added comfort and convenience. A special cutout helps to maintain the proper head and neck positioning when swallowing, making drinking even easier



Two Handled Mug

- Designed to make drinking safer and easier for people with hand tremors
- Supplied with two lids, one for anti-spill and one with a drinking spout and two handles to assist with control

DVA For eligibility & prescriber info please refer to pg 7.

DVA For eligibility & prescriber info please refer to pg 7.

Code	Description	Capacity	Product Wt.	RAP #:
DLK275480	Nosey Cup 115 Blue Tint	115 ml	45 g	AH01
DLK275490	Nosey Cup 225 Blue Tint	225 ml	45 g	AH01
DLK275500	Nosey Cup 340 Blue Tint	340 ml	45 g	AH01
DLK275510	Nosey Cup White	225 ml	45 g	AH01

Code	Description	RAP #:
DLK276520	Two Handled Mug	AH01



Incurve Plate Surround

- Attaches to dinner plate to assist with one-handed eating and prevent spillage
- Three clips attach it to the rim and create a high inward sloping face to help with food collection
- Fits a large range of plate sizes.
- Flexible nylon construction. Microwave and dishwasher safe



Inner Lip Plate

- Plate with an inner lip to hold food on plate while user scoops against it
- Polycarbonate sandstone colour
- Not for use with serrated knives
- Dishwasher and microwave safe up to 80°C

✓ DVA For eligibility & prescriber info please refer to pg 7.

Code	Description	Plate Size	Product Wt.	RAP #:
DLK276490	Incurve Plate Surround	190 - 254 mm	45 g	AH01

✓ DVA For eligibility & prescriber info please refer to pg 7.

Code	Description	Diameter	Product Wt.	RAP #:
DLK275290	Inner Lip Plate	228 mm	136 g	AH01



Manoy Plate

- Melamine oval shaped plate helps those with one good hand or who have difficulty picking up food with utensils
- Sloping bottom and high sided end to help scoop up food without spilling it over the side
- Not suitable for microwave ovens, but dishwasher safe



Medici Plate

- A deep dished plate to assist with picking up food
- Made from tough scratch-resistant plastic
- The large contoured rim makes the plate easier to grip
- It is lightweight, stackable, microwaveable and dishwasher safe

✓ DVA For eligibility & prescriber info please refer to pg 7.

Code	Description	Dimensions	Product Wt.	RAP #:
DLK276450	Manoy Plate Small	227 x 159 mm	200 g	AH01
DLK276460	Manoy Plate Large	279 x 159 mm	440 g	AH01

✓ DVA For eligibility & prescriber info please refer to pg 7.

Code	Description	External Diameter	Product Wt.	RAP #:
DLK276480	Medici Plate	241 mm	180 g	AH01



Plate Guard

- Attaches to dinner plate to assist with one-handed eating and prevent spillage
- High temp plastic ring snaps around plate
- Fits a large range of plate sizes
- Crystal clear plastic is easy to keep clean
- Dishwasher safe to 50°C
- Latex free, small or large sizes
- Not suitable for microwave



Economy Scoop Dish

- Plate with a high curved lip to scoop food against
- Assists those with one good hand or who have difficulty picking up food with utensils
- Non slip rubber coated base to prevent sliding
- Dishwasher and microwave safe
- Washes in top shelf of domestic dishwashers
- Not recommended for microwave use

✓ DVA For eligibility & prescriber info please refer to pg 7.

Code	Description	Plate Size	Product Wt.	RAP #:
DLK275440	Plate Guard Small	150 - 190 mm	68 g	AH01
DLK275450	Plate Guard Large	220 - 250 mm	105 g	AH01

✓ DVA For eligibility & prescriber info please refer to pg 7.

Code	Description	Diameter	Product Wt.	RAP #:
DLK275300	Economy Scoop Dish	200 mm	45 g	AH01



Reacher Economy

- Hook trigger
- Easy closing jaw
- Trigger enables reacher to hang on a walker or chair
- Slip resistant jaw surface provides a secure hold
- Available in two lengths

DVA For eligibility & prescriber info please refer to pg 7.



Handireacher

- An ultra lightweight, robust reacher
- Single moving jaw operated with a trigger action from the handle
- The head has a magnet for picking up small metal objects e.g. pins, and a hook to aid dressing
- The jaw can rotate 360° to avoid the need to rotate the wrist
- The trigger, operated by four fingers instead of the usual two is easy to grip and operate

DVA For eligibility & prescriber info please refer to pg 7.

Code	Description	RAP #:
DLR279010	Reacher Economy 685 mm	AH11
DLR279020	Reacher Economy 838 mm	AH11

Code	Description	Product Wt.	RAP #:
DLR279110	Handireacher 610 mm	180 g	AH11
DLR279120	Handireacher 760 mm	200 g	AH11
DLR279130	Handireacher 890 mm	220 g	AH11



Pick Up Reacher

- A unique lightweight, robust and wear resistant reacher
- Ideal for retrieving or reaching a wide variety of items in the home, garden or out shopping
- Available in four lengths, with or without optional extras
- Twin gripping jaws and a magnetic head ideal for easy retrieval of pins, paper clips and other small ferrous items
- Trigger design is comfortable to use and short trigger action is ideal for stiff, arthritic fingers
- Rotatable head to suit individual tasks
- Removable stick clip allowing it to be clipped on to wheelchairs and walking frames

DVA For eligibility & prescriber info please refer to pg 7.

Code	Description	RAP #:
DLR279220	Pick Up 340 mm	AH11
DLR279150	Pick Up 600 mm	AH11
DLR279170	Pick Up 750 mm	AH11
DLR279230	Pick Up 900 mm	AH11
DLR279160	Pick Up 600 mm + lock & forearm support	AH11
DLR279180	Pick Up 750 mm + lock & forearm support	AH11

REFER TO OTHER SHOWER & OTHER TOILET PG 53 & 58 FOR OTHER GENERAL BATHROOM AIDS



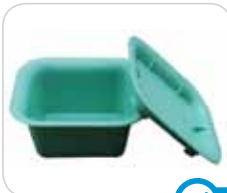

Denture Box

- Denture Box designed for bedside storage
- Comes complete with a lid
- Autoclavable for easy sanitising

DVA For eligibility & prescriber info please refer to pg 7.

Code	Description	RAP #:
DLG271060	Denture Box	AU03
DLG271190	Denture Brush w/ Suction Cup	AU03

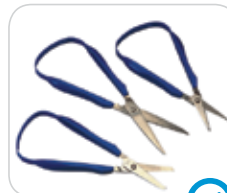

Easigrip Scissors

- Easigrip Scissors are extremely lightweight
- Handle automatically reopens the scissors when pressure is released

DVA For eligibility & prescriber info please refer to pg 7.

Code	Description	Blade Len.	Product Wt	RAP #:
DLG271330	Easigrip Scissors Round	45 mm	30 g	AH12
DLG271340	Easigrip Scissors Pointed	45 mm	30 g	AH12
DLG271350	Easigrip Scissors Pointed Long	75 mm	46 g	AH12



Easigrip Chiropodist Scissors

- The long loop handles allow the whole hand to be used for controlling the scissors
- This is ideal for those with a weak grip

DVA For eligibility & prescriber info please refer to pg 7.

Code	Description	Overall Len.	Blade Len.	Product Wt.	RAP #:
DLG271360	Easigrip Chiropodist Scissors	200 mm	30 mm	55 g	AH12



Long Handled Dustpan & Brush

- This plastic dustpan and soft bristled brush have long stems and plastic handles and are designed to reduce bending down to sweep up
- The brush clips on to the dustpan stem for storage

Code	Description	Length	Product Weight
DLG271500	Long Handled Dustpan & Brush	970 mm	550 g



Magnifying Viewers with Neck Cord

- This magnifier hangs from a neck cord and has a moulded plastic frame that fits against the body to position the viewer without using the hands

DVA For eligibility & prescriber info please refer to pg 7.

Code	Description	Lens Diameter	Product Wt.	RAP #:
DLG271530	Magnifying Viewers with Neck Cord	100 mm	186 g	AH17

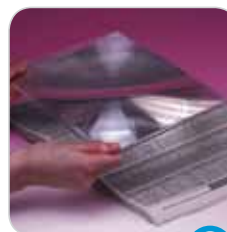

Magnifying Viewer Sheet

- This rigid plastic sheet gives a convenient and inexpensive way of reading large areas of print. Sold as a pair
- Magnification x 2

DVA For eligibility & prescriber info please refer to pg 7.

Code	Description	Dimensions	Product Wt.	RAP #:
DLG271540	Magnifying Viewer Sheet	255 x 182 mm	85 g	AH17



Book Stand

- Lightweight and stable stand holds books or magazines up and open
- Ideal as an aid for cooking or typing
- Folds flat for storage

DVA For eligibility & prescriber info please refer to pg 7.

Code	Description	Size Folded	Product Wt.	RAP #:
DLG271560	Book Stand	305 x 229 mm	670 g	AH04



Book Seat

- Book Rest supports books and magazines
- Book/Page Holder - ensures pages of book remain open without hands
- Beans inside the Book Rest adjust to any surface (flat or uneven) - perfect for reading in bed

Code	Description
GSP	Book Seat



Safety Alert Bracelet

- Medical information locket worn as jewellery

DVA For eligibility & prescriber info please refer to pg 7.

Code	Description	RAP #:
DLG271950	Safety Alert Bracelet - SOS Ladies	AS16
DLG271951	Safety Alert Bracelet - SOS Mens	AS16



Handy Bar

- The Handy Bar inserts into the U-shaped striker plate on your vehicle door frame to help support getting out of the car

DVA For eligibility & prescriber info please refer to pg 7.

Code	Description	Length	Max. User Weight	Product Weight	RAP #:
DLG271670	Handy Bar	230 mm	158 kg	0.31 kg	AP09

Laundry & Cleaning



- P 131 Linen Trolleys
- P 132 Clean Linen/Storage
- P 134 Cleaning



Soiled Linen Trolley (No Lid)

- Mobile linen skip
- Transport and dispose soiled linen in the hospital or aged care environment
- Robust frame
- Perforated sheet metal bag supports
- Twin 75mm swivel castors
- Available in stainless steel (SS) or white epoxy powder coated frame

Code	Description	Length	Width	Height	Supplier Code
LAC353730 1	Single Epoxy Coated	425 mm	460 mm	895 mm	KH540
LAC353800 2	Double Epoxy Coated	870 mm	460 mm	895 mm	KH541
LAC353880 3	Triple Epoxy Coated	1265 mm	460 mm	895 mm	KH542
LAC353770	Single S/S	425 mm	460 mm	895 mm	KH540S
LAC353850	Double S/S	870 mm	460 mm	895 mm	KH541S
LAC353915	Triple S/S	1265 mm	460 mm	895 mm	KH542S

- Warranty: 36 months
- Optional castors: Grey rubber 100 mm (CA10030)



Soiled Linen Trolley (Manual Lid)

- Mobile linen skip with manually operated Lid
- Transport and dispose soiled linen in the hospital or aged care environment
- Robust frame
- Perforated sheet metal bag supports
- Twin 75mm swivel castors
- Available in stainless steel (SS) or white epoxy powder coated frame
- Warranty: 36 months

Code	Description	Length	Width	Height	Supplier Code
LAC353760 1	Single Epoxy w/ Manual Lid	425 mm	460 mm	920 mm	KH540LM
LAC353870 2	Double Epoxy w/ Manual Lid	870 mm	460 mm	920 mm	KH541LM
LAC353910	Triple Epoxy w/ Manual Lid	1265 mm	460 mm	920 mm	KH542LM
LAC353790	Single S/S w/ Manual Lid	425 mm	460 mm	920 mm	KH540SLM
LAC353870	Double S/S w/ Manual Lid	870 mm	460 mm	920 mm	KH541SLM
LAC353930	Triple S/S w/ Manual Lid	1265 mm	460 mm	920 mm	KH542SLM



Soiled Linen Trolley (Foot Operated Lid)

- Mobile linen skip with foot operated lid
- Foot operated lid is ideal for infection control
- Transport and dispose soiled linen in the hospital or aged care environment
- Robust frame
- Perforated sheet metal bag supports
- Twin 75mm swivel castors
- Available in stainless steel (SS) or white epoxy powder coated frame

Code	Description	Length	Width	Height	Supplier Code
LAC353740 1	Single Epoxy w/ Foot Lid	425 mm	460 mm	900 mm	KH540L
LAC353810 2	Double Epoxy w/ Foot Lid	870 mm	460 mm	900 mm	KH541L
LAC353890 3	Triple Epoxy w/ Foot Lid	1265 mm	460 mm	900 mm	KH542L
LAC353780	Single S/S w/ Foot Operated Lid	425 mm	460 mm	900 mm	KH540SL
LAC353860	Double S/S w/ Foot Operated Lid	870 mm	460 mm	900 mm	KH541SL
LAC353920	Triple S/S w/ Foot Operated Lid	1265 mm	460 mm	900 mm	KH542SL

- Comes with white plastic lid
- Warranty: 36 months



Soiled Linen Trolley Lids

- Replacement lid for Foot Operated Linen Skips
- Lids available in a variety of colours
- Warranty: 12 months

Code	Description	Supplier Code
LAC354130	Soiled Linen Trolley Lid Plastic - Red	KH54LR
LAC354150	Soiled Linen Trolley Lid Plastic - Yellow	KH54LY
LAC354110	Soiled Linen Trolley Lid Plastic - Green	KH54LG
LAC354140	Soiled Linen Trolley Lid Plastic - White	KH54LW
LAC354100	Soiled Linen Trolley Lid Plastic - Blue	KH54LB



Soiled Linen Bags

- Replacement Linen Bags to suit linen skips
- Available as standard or waterproof

Code	Description
LAC353130	Linen Bag with Drawstring S4 White
LAC353140	Linen Bag with Drawstring S4 Blue
LAC353160	Linen Bag with Drawstring S4 Green
LAC353170	Linen Bag with Drawstring S4 Red
LAC353180	Linen Bag with Drawstring S4 Yellow
LAC353190	Linen Bag with Drawstring S4 Purple
LAC353060	Linen Bag Waterproof White
LAC353020	Linen Bag Waterproof Blue
LAC353040	Linen Bag Waterproof Green
LAC353050	Linen Bag Waterproof Red
LAC353070	Linen Bag Waterproof Yellow
LAC353030	Linen Bag Waterproof Black



Bulk Soiled Linen/ Garbage Trolley

- Mobile Soiled Linen/Garbage trolley
- Transport and dispose soiled linen or garbage in the hospital or aged care environment
- 200mm grey rubber castor
- Hanging lockable door
- Warranty: 36 months
- Pictured with gas assisted lid.

Code	Description	Length	Width	Height	Supplier Code
LAC353950	Bulk Soiled Linen / Garbage Trolley Small	1200 mm	625 mm	1240 mm	KH545
LAC353960	Bulk Soiled Linen / Garbage Trolley Large	1650 mm	800 mm	1200 mm	KH545S
LAC353970	Bulk Soiled Linen Trolley Gas Assisted Lid				KH545L



Moist Linen Trolley

- Mobile moist linen trolley
- Transport and dispose soiled linen in the hospital or aged care environment
- Galvanised base
- 125mm heavy duty nylon swivel castors
- Warranty: 36 months

Code	Description	Length	Width	Height	Supplier Code
LAC353980	Moist Linen Trolley Small	1000 mm	700 mm	800 mm	KH547
LAC354010	Moist Linen Trolley Small Spring Loaded Base Only, Galvanized				KH547SB
LAC354030	Moist Linen Trolley Large	1380 mm	750 mm	800 mm	KH548
LAC354050	Moist Linen Trolley Large Base Only, Spring Loaded & Galvanized				KH548SB



Wet & Dry Trolley

- Mobile moist linen trolley
- Transport and dispose soiled linen in the hospital or aged care environment
- Galvanized plus zinc rich epoxy coated frame
- 125mm heavy duty nylon swivel castors
- Spring loaded base is ideal to assist in occupational health & safety
- Also available with heavy duty spring coil base
- Warranty: 36 months
- Optional:
LAC354220 Laundry Trolley Push Handle for KH551/KH552 Bolt/On
LAC354230 Laundry Trolley Spring Cover for KH551/KH552 Vinyl

Code	Description	Length	Width	Height	Supplier Code
LAC354170	Laundry Trolley Wet/Dry with Spring Base Small	800 mm	600 mm	800 mm	KH550B
LAC354180	Laundry Trolley Wet/Dry with Spring Base Medium	1050 mm	700 mm	850 mm	KH551B
LAC354200	Laundry Trolley Wet/Dry with Spring Base Large	1250 mm	700 mm	850 mm	KH552B
LAC353380	Laundry Trolley Wet/Dry Small with Coil Base	800 mm	600 mm	800 mm	KH550C
LAC354190	Laundry Trolley Wet/Dry with Coil Spring Base Medium	1050 mm	700 mm	850 mm	KH551C
LAC354210	Laundry Trolley Wet/Dry with Coil Spring Base Large	1250 mm	700 mm	850 mm	KH552C



Clean Linen Trolley Economy-Open both Sides

- Open both sides for easy access
- Mobile clean linen trolley
- Transport clean linen in the hospital or aged care environment
- Lightweight construction
- 125mm castors, wall buffer discs, two shelves, top tray and push handle

Code	Description	Length	Width	Height	Supplier Code
LAC353640	Clean Linen Trolley Open Both Sides Economy (Small)	900 mm	570 mm	1060 mm	KH528
LAC353610	Clean Linen Trolley Open Both Sides Economy (Large)	1190 mm	550 mm	1430 mm	KH526
GSP	Drive Unit				KH525DU

- Warranty: 36 months



Clean Linen Trolley Economy

- Mobile clean linen trolley
- Transport clean linen in the hospital or aged care environment
- Lightweight construction
- 125mm castors, wall buffer discs, two shelves, top tray and push handle
- Warranty: 36 months

Code	Description	Length	Width	Height	Supplier Code
LAC353620	Clean Linen Trolley Closed Side Economy (Small)	900 mm	570 mm	1060 mm	KH527
LAC353590	Clean Linen Trolley Closed Side Economy (Large)	1190 mm	550 mm	1430 mm	KH525



Clean Linen Trolley

- Mobile clean linen trolley
- Transport clean linen in the hospital or aged care environment
- Lightweight aluminium body and shelves
- 200mm rubber castors, full wrap wall bumper, three shelves, top multi height push handle
- Pictured with drive unit (optional)
- Warranty: 36 months

Code	Description	Length	Width	Height	Supplier Code
LAC353560	Clean Linen Trolley	1290 mm	640 mm	1440 mm	KH522
LAC353570	Clean Linen Trolley Front Cover with Straps	870 mm	460 mm	895 mm	KH522FC
GSP	Drive Unit				KH522DU



Garment Rack

- Mobile garment hanger
- Store hanging garments in an orderly fashion in a multi user environment
- 125mm grey rubber swivel castors
- 100mm buffers discs for wall protection
- Lightweight durable construction
- Warranty: 36 months

Code	Description	Length	Width	Height	Supplier Code
LAC353450	Garment Rack	1420 mm	680 mm	1730 mm	KH512
LAC353460	Garment Rack S/S	1420 mm	680 mm	1730 mm	KH512S



Storage Basket Trolley

- Mobile personal laundry trolley for storage or laundry distribution
- Different basket quantity configurations available to suit facility needs
- Easy to remove individualised plastic storage baskets
- Individual name tags
- 125mm grey rubber swivel castors
- 100mm buffers discs for wall protection

Code	Description	Length	Width	Height	Supplier Code
LAC353650	Storage Basket Trolley 15	1105 mm	450 mm	1305 mm	KH529
LAC353660	Storage Basket Trolley 18	1104 mm	465 mm	1530 mm	KH529-18
LAC353670	Storage Basket Trolley 21	1104 mm	465 mm	1305 mm	KH529-21
LAC353680	Storage Basket Trolley 30	1470 mm	685 mm	1330 mm	KH529-30

- Basket size: 430mm(L)x353mm(W)x127mm(H)
- Warranty: 36 months



Utility Cart

- Transports or manoeuvres equipment and supplies in the home, hospital or aged care facility
- Large shelves hold various equipment and supplies
- Lightweight frame for easy manoeuvrability
- 125mm grey rubber swivel castors
- Available in black or white

Code	Description	Length	Width	Height	Weight Capacity	Warranty
LAC353011	Utility Cart Black	960 mm	1030 mm	508 mm	136 kg	12 months
LAC353010	Utility Cart White	960 mm	1030 mm	508 mm	136 kg	12 months



Garbage Trolley Mobile

- Mobile garbage trolley
- Foot operated lid ideal for infection control
- Transport and dispose garbage in the hospital or aged care environment
- Perforated sheet metal bag support
- Twin 75mm swivel castors
- Comes with plastic lid, suits plastic or paper bags

Code	Description	Length	Width	Height	Supplier Code
LAC354250	Garbage Trolley Mobile	420 mm	420 mm	920 mm	KH587

- Single, Double, Triple
- Lightweight white epoxy powder coated frame for corrosion resistance
- Warranty: 36 months



Garbage Holder Wall Mounted

- Wall mounted garbage bag holder
- Foot operated lid is convenient and ideal for infection control
- Perforated sheet metal bag support
- White epoxy powder coated frame for corrosion resistance
- Comes with plastic lid, suits plastic or paper bags
- Warranty: 36 months

Code	Description	Length	Width	Height	Supplier Code
LAC354240	Garbage Holder Wall Mounted	370 mm	400 mm	875 mm	KH585



Cleaning Cart

- Mobile cleaning equipment cart
- Flexible, high capacity storage solution that also organises your cleaning tools
- Lock N' Go bucket attachment
- Two removable disinfecting caddies
- Aluminium and web plastic construction to avoid corrosion

Code	Description	Length	Width	Height	Warranty
LAC353012	Cleaning Cart with Zippered Yellow Vinyl Bag	975 mm	1264 mm	552 mm	12 months
LAC353013	Cleaning Cart Locking Cabinet	508 mm	406 mm	286 mm	12 months



Platform Trolley

- Used to transport variety of goods in hospital and aged care environments
- Features two fixed and two swivel castors for easy transportation
- Heavy duty sheet metal desk and wrap around PVC bumper
- Warranty: 12 months

Code	Description	Length	Width	Height	Supplier Code
LAC353390	Platform Trolley Small	840 mm	540 mm	900 mm	KH500
LAC353400	Platform Trolley Medium	980 mm	630 mm	920 mm	KH502
LAC353410	Platform Trolley Large	1130 mm	730 mm	950 mm	KH504

Aidacare Online

For all of your product enquiries in one user-friendly site visit us online at www.aidacare.com.au

- New product releases - updated daily
- Clear and concise product descriptions and specifications
- Contract specific ordering information (DVA, TAC & MASS)
- Downloadable DVA RAP and other order forms
- Full colour product images
- Information on our range of service offerings
- Newsletter subscription page

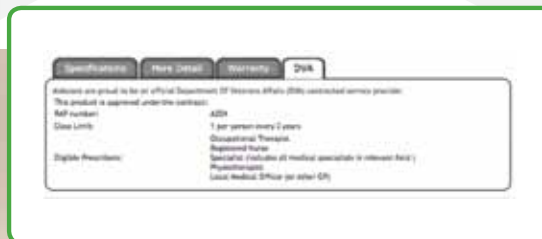

"We care for your care"



Manual Handling - Lifters & Slings



- P 137 Lifters & Slings Overview
- P 138 Kerry Lifters
- P 140 Kerry Lifter Accessories
- P 141 Kerry Slings
- P 144 Oxford Lifters
- P 146 Oxford Lifter Accessories
- P 146 Oxford Slings
- P 147 Specialty Lifters



Lifters & Slings Overview

FIM Score

FIM is a widely used assessment tool to classify a person's function from independence to total assistance in 7 levels:

What are the 7 levels?	Type of Lifter	Type of Sling
COMPLETE INDEPENDENT 7. Complete Independence Another person is not required for the activity which is performed safely without modification or outside assistance within a reasonable time. 6. Modified Independence Activity requires one or more of the following: an assistive device, more than reasonable time or safety (risk) considerations	None None	None None
DEPENDENT 5. Supervision or set up Someone required to help by observation or encouragement without contact. 4. Minimal Assistance Someone required to help - by touching - subject makes 75% or more of the effort. 3. Moderate Assistance Someone required to help by more than touching - subject makes 50% - 75% of the effort.	Standing Lifter Standing Lifter Standing Lifter /Patient Lifter/ Multi Lifter	None Standing Slings Standing Slings /Lifting Slings
COMPLETE DEPENDENCE 2. Maximal Assistance Complete dependence. Subject makes less than 50% but at least 25% of effort. 1. Total Assistance Complete dependence. Subject makes less than 25% of effort.	Patient Lifter Patient Lifter/ Overhead System	Lifting Slings Lifting Slings

Please note that staff in ALL areas must have immediate access to at least one mobile passive hoist for use in the event of an emergency such as the retrieval of a patient who has fallen. A passive hoist suitable for a very heavy person should also be accessible within the facility/hospital and all staff should be aware of the system for accessing the hoist as required. (For example: in the event of an unplanned admission of a very heavy patient into Accident and Emergency).

Selecting the Type of Sling for the Most Common Tasks

To simplify the process of sling selection, we have developed a chart to guide you in the appropriate use of each sling and task. There will, of course, be exceptions to this guide, but this reference enables a view of what tasks can be completed.

Lifter Type	Sling Type	Toilet	Commode to Bath	Chair to Chair	Bed to Chair	Floor to Bed	Chair to Commode	Emergency
Patient Lifter	Access	●		●			●	
Patient Lifter	General Purpose	●	●	●	●	●		
Patient Lifter	Quick Fit	●	●	●	●	●		●
Patient Lifter	Full Body	●		●	●	●		
Patient Lifter	Comfort	●	●	●	●	●		
Standing/Multi Lifter	Standing	●		●	●		●	



Home Care Lifter

- Mobile patient lifter for transfer to a seated or lying position
- Versatile unit that dismantles for transport and storage, suitable for domestic use
- Epoxy powder coated frame
- Single speed handset control
- Emergency lowering
- Wide push handle for excellent manoeuvrability
- 125 mm rear total lock castors and 75 mm front twin swivel castors
- Manual foot operated leg gating for close access

✓ DVA CONTRACTED
 AM01..... HIRE (P.A Rqd)
 Prescribers... Phys/OT/RN/S/LMO
 For approval rules refer to pg 7.

- Suits a large range of patient slings
- Supplied with battery and charger
- Load capacity 150 kg
- Warranty: 24 months



Code	Description	Length	Width	Height	Leg Gate	Lift Range	Product Weight	Max. User Weight	Supplier Code	✓ RAP #:
LSS379500	Home Care Lifter	1150 mm	670 mm	1100 mm	510 - 900 mm	430 - 1700 mm	37 kg	150 kg	KH402	AM01



Swift Lift Lifter

- Mobile patient lifter for transfer to a seated or lying position
- Robust construction makes it ideal for aged care facilities
- Epoxy powder coated frame
- Dual speed hand control operation
- Emergency lowering and raising
- Over-sized push handles for excellent manoeuvrability
- Electric leg gating
- Suits a large range of patient slings
- Supplied with battery and charger
- Load capacity 150 kg
- Warranty: 24 months

✓ DVA CONTRACTED
 AM01..... HIRE (P.A Rqd)
 Prescribers... Phys/OT/RN/S/LMO
 For approval rules refer to pg 7.



LSS379600

Code	Description	Length	Width	Height	Leg Gate	Lift Range	Product Weight	Max. User Weight	Supplier Code	✓ RAP #:
LSS379700	Swift Lift	1100 mm	670 mm	1220 mm	510 - 885 mm	430 - 1700 mm	39 kg	150 kg	KH404F	AM01
LSS379600	Swift Lift Lifter Drive Unit	1100 mm	670 mm	1220 mm	510 - 885 mm	430 - 1700 mm	55 kg	150 kg	KH404DU	-

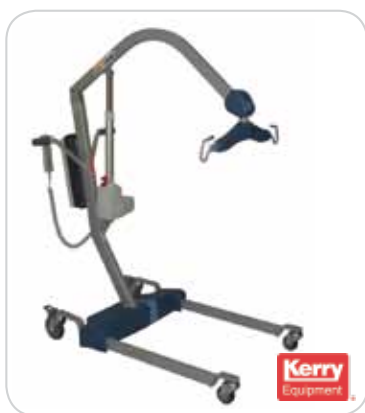

Swift Lift Home Care Advantage Lifter

- Mobile patient lifter for transfer to a seated or lying position
- Premier version of Swift Lift model (LSS379700)
- Robust epoxy powder coated frame construction makes it ideal for aged care facilities
- Concave mast provides more leg room for users
- Dual speed hand control operation
- Emergency lowering and raising
- Over-sized push handles for excellent manoeuvrability
- Electric leg gating
- Single hook yoke and sling retaining system gives a smaller lifting footprint
- Suits a large range of slings
- Supplied with battery and charger
- Larger load capacity of 160 kg
- Warranty: 24 months

Code	Description	Length	Width	Height	Leg Gate	Lift Range	Product Weight	Max. User Weight	Supplier Code
LSS379750	Swift Lift Advantage	1070 mm	615 mm	1240 mm	615 - 1015 mm	480 - 1720 mm	40 kg	160 kg	KH404FP



Ezy Lift Lifter

- Mobile patient lifter for transfer to a seated or lying position
- Ideal for use with weight scale or pivot frame
- Large load capacity of 225 kg
- Robust epoxy powder coated frame construction makes it ideal for aged care facilities
- Dual speed hand control operation
- Emergency lowering and raising
- Over-sized push handles for excellent manoeuvrability
- Electric leg gating
- Suits a large range of patient slings
- Supplied with battery and charger
- Warranty: 24 months

✓ DVA CONTRACTED
 AM01..... HIRE (P.A Rqd)
 Prescribers... Phys/OT/RN/S/LMO
 For approval rules refer to pg 7.



LSS379850

Code	Description	Length	Width	Height	Leg Gate	Lift Range	Product Weight	Max. User Weight	Supplier Code	✓ RAP #:
LSS379800	Ezy Lift	1235 mm	670 mm	1315 mm	510 - 1000 mm	430 - 1760 mm	47.5 kg	225 kg	KH405F	AM01
LSS379850	Ezy Lift Lifter Drive Unit	1235 mm	670 mm	1315 mm	510 - 1000 mm	430 - 1760 mm	55 kg	225 kg	KH405DU	-



Maxi Lift Lifter

- Mobile patient lifter for transfer to a lying, seated or standing position
- The Maxi Lift is designed to assist the carer when transferring bariatric patients with a maximum user weight of 300 kg
- Suitable for large facilities with special patient requirements
- Supplied standard with battery and charger
- Warranty: 24 months

Code	Description	Length	Width	Height	Leg Gate	Lift Range	Product Weight	Max. User Weight	Supplier Code
LSS362100	Maxi Lift	1445 mm	770 mm	1460 mm	590 - 1090 mm	600 - 1800 mm	70 kg	300 kg	KH406



Quik Stand Lifter

- Mobile patient lifter and stander to lift and transfer persons in a standing position
- Robust epoxy powder coated frame and urethane coated legs, handle bars & knee pads is ideal for facilities
- Electric hand control operation
- Emergency lowering and raising
- Wide push handles for excellent manoeuvrability
- 125 mm rear locking castors and 75 mm front twin swivel castors
- Plastic cover for protection and easy cleaning
- Electric leg gating
- Supplied with battery and charger
- Load capacity of 150 kg
- Warranty: 12 months

✓ DVA CONTRACTED
 AM01..... HIRE (P.A Rqd)
 Prescribers... Phys/OT/RN/S/LMO
 For approval rules refer to pg 7.

Code	Description	Length	Width	Height	Leg Gate	Lift Range	Product Weight	Max. User Weight	Supplier Code	✓ RAP #:
LSS378300	Quik Stand Lifter	1050 mm	670 mm	910 mm	550 - 820 mm	820 - 1620 mm	43 kg	150 kg	KH400G	AM01

Manual Handling - Lifters & Slings



Quik Stand Economy Lifter

- Mobile patient lifter and stander to lift and transfer persons in a standing position
- Robust epoxy powder coated frame construction makes it ideal for facilities
- Electric hand control operation
- Wide push handles for excellent manoeuvrability
- 125 mm rear locking castors and 75mm front twin swivel castors
- Manual foot operated leg gating
- Supplied with battery and charger
- Load capacity of 150 kg
- Warranty: 24 months

✓ DVA CONTRACTED
AM01..... HIRE (P.A Rqd)
 Prescribers... Phys/OT/RN/S/LMO
 For approval rules refer to pg 7.

Code	Description	Length	Width	Height	Leg Gate	Lift Range	Product Weight	Max. User Weight	Supplier Code	✓ RAP #:
LSS378400	Quik Stand Economy Lifter	1200 mm	600 mm	910 mm	600 - 1000 mm	820 - 1620 mm	43 kg	150 kg	KH400GE	AM01



Multi Lift Lifter

- Mobile patient lifter for transfer to a lying, seated or standing position
- Versatile as a standing or conventional lifting hoist or a walking tutor
- Robust epoxy powder coated frame construction makes it ideal for aged care facilities
- Wall mounting bracket for boom spreader bar
- Dual speed electric hand control operation
- Emergency lowering and raising
- Manoeuvrability + Push handle
- 150 mm rear locking castors and 100 mm front twin swivel castors
- Electric leg gating
- Suits a large range of patient slings
- Supplied with battery and charger
- Load capacity of 150 kg
- Warranty: 24 months



LSS379300

Code	Description	Length	Width	Height	Leg Gate	Lift Range	Product Weight	Max. User Weight	Supplier Code
LSS379400	Multi Lift Lifter	1100 mm	670 mm	1220 mm	510 - 885 mm	430 - 1700 mm	54 kg	150 kg	KH401
LSS379300	Multi Lift Lifter Drive Unit	1445 mm	770 mm	1460 mm	590 - 1090 mm	600 - 1880 mm	88 kg	300 kg	KH401DU



Pivot Frames

- Carer controlled frame to pivot and manoeuvre a patient during transfers
- Easily adjustable angle from a 10 to 118 degrees off verticle
- Padded head section surrounding frame for user safety and comfort
- Allows a more comfortable user seating position and more control for the carer

✓ DVA CONTRACTED
AM01..... HIRE (P.A Rqd)
 Prescribers... Phys/OT/RN/S/LMO
 For approval rules refer to pg 7.

Code	Description	Suits Hoists	Suits Slings	Supplier Code	RAP #:
LSS383650	Pivot Frame with Hook sling location points (pictured)	LSS379500, LSS379700, LSS379800, LSS379300	Most standard slings with loop attachment	KH40PFH	-
LSS383600	Pivot Frame with Key Hole sling location points	LSS379500, LSS379700, LSS379750, LSS379800, LSS379300	LSS379900, LSS380000, LSS380100	KH40PF	AM01



Weigh Scale

- Digital weigh scale fits on the hoist range to weight a patient in transfer
- Replaces existing yoke on a hoist with no loss of lift height
- Warranty: 12 months

Code	Description	Weight Capacity	Supplier Code
LSS383700	Weigh Scale	300 kg	KH40WS



Standing Slings

- Attaches to hoist to enable a carer to lift and stand a less mobile user
- High density foam maximises user comfort and support
- Quick and easy to fit adjustable velcro waist band
- Colour coded attachment and positioning straps
- Designed for use with standing hoists

DVA For eligibility & prescriber info please refer to pg 7.

Code	Description	Max. User Wt.	Supplier Code	RAP #:
LSS378600	Standing Sling	250 kg	KH400SF	AM02
LSS378800	Standing Sling Large	250 kg	KH400SFL	AM02

- FIM Scores: 3 and 4
- Warranty: 12 months



Standing Slings with Buckle

- Attaches to hoist to enable a carer to lift and stand a less mobile user
- Quick and easy to fit adjustable velcro waist band and buckle for added security
- High density foam maximises user comfort and support
- Designed for use with standing hoists

DVA For eligibility & prescriber info please refer to pg 7.

Code	Description	Max. User Wt.	Supplier Code	RAP #:
LSS378700	S/ Sling with Buckle	250 kg	KH400SFB	AM02
LSS378900	S/ Sling with Buckle Large	250 kg	KH400SFLB	AM02

- Colour coded attachment and positioning straps
- Machine washable
- FIM Scores: 3 and 4
- Warranty: 12 months



Seating Slings

- Attaches to hoist to enable a carer to lift and stand a less mobile user
- High density foam maximises user comfort and support
- Designed for use with standing hoists
- Quick and easy to fit adjustable velcro waist band
- Colour coded attachment and positioning straps

DVA For eligibility & prescriber info please refer to pg 7.

Code	Description	Supplier Code	RAP #:
LSS379000	Seating Sling Large	KH400SSL	AM02
LSS379200	Seating Sling Medium	KH400SS	AM02

- Machine washable
- FIM Scores: 3 and 4
- Warranty: 12 months



General Purpose Slings - Mesh

- Attaches to hoist to enable a carer to lift and manoeuvre a less mobile user
- Made from a lightweight mesh which is ideal for showering or bathing and dries quickly
- Quick and easy to fit
- Ideal for non weight bearing patients
- Colour coded attachment and positioning straps

DVA For eligibility & prescriber info please refer to pg 7.

Code	Description	Max. User Weight	Supplier Code	RAP #:
LSS380500	G/ Purpose Sling Mesh S	250 kg	KH406NE1	AM02
LSS380600	G/ Purpose Sling Mesh M	250 kg	KH406NE2	AM02
LSS380700	G/ Purpose Sling Mesh L	250 kg	KH406NE3	AM02
LSS380800	G/ Purpose Sling Mesh XL	350 kg	KH406NE4	AM02

- Machine washable
- FIM Scores: 1 and 2
- Warranty: 12 months



General Purpose Slings

- Attaches to hoist to enable a carer to lift and manoeuvre a less mobile user
- Quick and easy to fit
- Ideal for non weight bearing patients
- Colour coded attachment and positioning straps
- Machine washable

DVA For eligibility & prescriber info please refer to pg 7.

Code	Description	Max. User Wt.	Supplier Code	RAP #:
LSS380900	G/ Purpose Sling Small	250 kg	LR406NF1	AM02
LSS381000	G/ Purpose Sling Medium	250 kg	LR406NF2	AM02
LSS381100	G/ Purpose Sling Large	250 kg	LR406NF3	AM02
LSS381200	G/ Purpose Sling Extra Large	350 kg	LR406NF4	AM02

- FIM Scores: 1 and 2
- Warranty: 12 months



General Purpose Slings with Head Support

- Attaches to hoist to enable a carer to lift and manoeuvre a less mobile user
- Provides excellent back and head support for patients requiring support during transfers
- Quick and easy to fit
- Ideal for non weight bearing patients

DVA For eligibility & prescriber info please refer to pg 7.

Code	Description	Max. User Wt.	Supplier Code	RAP #:
LSS381500	G/ Purpose Sling w/ Head Support S	250 kg	KH407N1	AM02
LSS381600	G/ Purpose Sling w/ Head Support M	250 kg	KH407N2	AM02
LSS381700	G/ Purpose Sling w/ Head Support L	250 kg	KH407N3	AM02
LSS381750	G/ Purpose Sling w/ Head Support XL	350 kg	KH407N4	AM02

- Colour coded attachment and positioning straps
- Machine washable
- FIM Scores: 1 and 2
- Warranty: 12 months



General Purpose Slings Mesh with Head Support

- Attaches to hoist to enable a carer to lift and manoeuvre a less mobile user
- Made from a lightweight mesh which is ideal for showering or bathing and dries quickly
- Provides excellent back and head support for patients requiring support during transfers
- Ideal for non weight bearing patients

DVA For eligibility & prescriber info please refer to pg 7.

Code	Description	Max. User Wt.	Supplier Code	RAP #:
LSS381800	G/ Purpose Sling Mesh Head Support S	250 kg	KH407NE1	AM02
LSS381900	G/ Purpose Sling Mesh Head Support M	250 kg	KH407NE2	AM02
LSS382000	G/ Purpose Sling Mesh Head Support L	250 kg	KH407NE3	AM02
LSS382100	General Purpose Sling Mesh Head Support XL	350 kg	KH407NE4	AM02

- FIM Scores: 1 and 2
- Warranty: 12 months

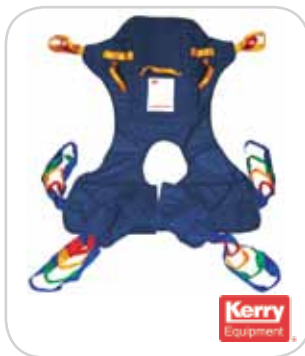

Full Body Slings

- Attaches to hoist to enable a carer to lift and manoeuvre a less mobile user for toileting
- Provides excellent back and head support for patients requiring support during transfers
- Divided leg is ideal for toileting patients who require full body support
- Quick and easy to fit

DVA For eligibility & prescriber info please refer to pg 7.

Code	Description	Max. User Wt.	Supplier Code	RAP #:
LSS382300	Full Body Sling S	250 kg	KH408N1	AM02
LSS382400	Full Body Sling M	250 kg	KH408N2	AM02
LSS382500	Full Body Sling L	250 kg	KH408N3	AM02
LSS382550	Full Body Sling XL	350 kg	KH408N4	AM02

- Colour coded attachment and positioning straps
- Machine washable
- FIM Scores: 1 and 2
- Warranty: 12 months



Full Body Slings - Mesh

- Attaches to hoist to enable a carer to lift and manoeuvre a less mobile user
- Made from a lightweight mesh which is ideal for showering or bathing and dries quickly
- Divided leg is ideal for toileting patients who require full body support
- Provides excellent back and head support for patients requiring support during transfers

DVA For eligibility & prescriber info please refer to pg 7.

Code	Description	Max. User Wt.	Supplier Code	RAP #:
LSS382600	Full Body Sling Mesh S	250 kg	KH408NE1	AM02
LSS382700	Full Body Sling Mesh M	250 kg	KH408NE2	AM02
LSS382875	Full Body Sling Mesh M w/ Key Hole Attachment	250 kg	KHXSP10367	AM02
LSS382800	Full Body Sling Mesh L	250 kg	KH408NE3	AM02
LSS382850	Full Body Sling Mesh XL	350 kg	KH408NE4	AM02

- Colour coded attachment and positioning straps
- Machine washable
- FIM Scores: 1 and 2
- Warranty: 12 months

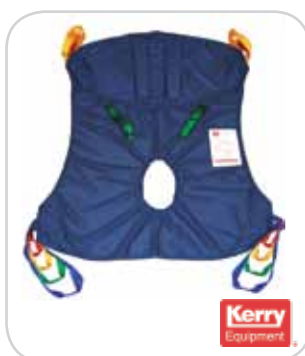

Hammock Slings - Fabric

- Attaches to hoist to enable a carer to lift and manoeuvre a less mobile user
- Shape is ideal for single or double amputees
- High density foam padding maximises user comfort and support
- Colour coded attachment and positioning straps

DVA For eligibility & prescriber info please refer to pg 7.

Code	Description	Max. User Weight	Supplier Code	RAP #:
LSS382900	Hammock Sling S	250 kg	KH409N1	AM02
LSS383000	Hammock Sling M	250 kg	KH409N2	AM02
LSS383100	Hammock Sling L	250 kg	KH409N3	AM02

- Quick and easy to fit
- Machine washable
- FIM Scores: 1 and 2
- Warranty: 12 months



Hammock Slings - Mesh

- Attaches to hoist to enable a carer to lift and manoeuvre a less mobile user
- Made from a lightweight mesh which is ideal for showering or bathing and dries quickly
- Quick and easy to fit
- Ideal for non weight bearing patients
- Colour coded attachment and positioning straps
- Machine washable

DVA For eligibility & prescriber info please refer to pg 7.

Code	Description	Max. User Weight	Supplier Code	RAP #:
LSS380500	Hammock Sling Mesh S	250 kg	KH409NE1	AM02
LSS380600	Hammock Sling Mesh M	250 kg	KH409NE2	AM02
LSS380700	Hammock Sling Mesh L	250 kg	KH409NE3	AM02

- FIM Scores: 1 and 2
- Warranty: 12 months



Pivot Slings

- Attaches to hoist to enable a carer to lift and manoeuvre a less mobile user
- Designed to be used on a hoist with pivot frame attachment
- Unique keyhole attachment
- Quick and easy to fit
- Machine washable
- FIM Scores: 1 and 2
- Warranty: 12 months

DVA For eligibility & prescriber info please refer to pg 7.

Code	Description	Max. User Weight	Supplier Code	RAP #:
LSS379900	Pivot Sling Small	250 kg	KH405N1	AM02
LSS380000	Pivot Sling Medium	250 kg	KH405N2	AM02
LSS380100	Pivot Sling Large	250 kg	KH405N3	AM02



Quickfit Slings

- Attaches to hoist to enable a carer to lift and manoeuvre a less mobile user
- Ideal for lifting people from the floor and for use with amputees
- Quick and easy to fit
- Colour coded attachment and positioning straps
- Optional padded version (LSS384075) has extra padding on leg supports for added comfort

DVA For eligibility & prescriber info please refer to pg 7.

Code	Description	Max. User Weight	Supplier Code	RAP #:
LSS384075	Quickfit Sling Padded M	250 kg	KH410PN2	AM02
LSS384100	Quickfit Sling Padded L	250 kg	KH410PN3	AM02
LSS383800	Quickfit Sling S	250 kg	KH410N1	AM02
LSS383900	Quickfit Sling M	250 kg	KH410N2	AM02
LSS384000	Quickfit Sling L	250 kg	KH410N3	AM02
LSS384050	Quickfit Sling XL	250 kg	KH410N4	AM02

- Machine washable
- FIM Scores: 1 and 2
- Warranty: 12 months



Access Toileting Slings

- Attaches to hoist to enable a carer to lift and manoeuvre a less mobile user for toileting
- User must have good trunk control and be partial weight bearing
- Quick and easy to fit
- Colour coded attachment and positioning straps
- Note: should not be used for non-weight bearing patients

DVA For eligibility & prescriber info please refer to pg 7.

Code	Description	Max. User Weight	Supplier Code	RAP #:
LSS372500	Access Toileting Sling S	250 kg	SU10075	AM02
LSS372600	Access Toileting Sling M	250 kg	SU10074	AM02
LSS372700	Access Toileting Sling L	250 kg	SU10073	AM02
LSS372710	Access Toileting Sling XL	250 kg	SU10073	AM02

- Machine washable
- FIM Scores: 2 and 3
- Warranty: 12 months



Oxford Presence

- Mobile patient lifter for transfer to a seated or lying position
- High lifting range accommodates transfers to higher surfaces
- Large load capacity of 227 kg
- Robust epoxy powder coated frame construction makes it ideal for facilities
- Electric hand control operation
- Emergency lowering and raising
- Over-sized push handles for excellent manoeuvrability
- 100 mm rear locking castors and 100 mm front twin swivel castors
- Electric leg gating
- Suits a large range of patient slings
- Supplied with battery and charger
- Pictured with optional 4 point pivot frame (LSS377395)



Code	Description	Length	Width	Height	Leg Gate	Lift Range	Warranty	Product Weight	Max. User Weight
LSS377325	Presence	1460 mm	670 mm	1460 mm	550 - 1020 mm	350 - 1850 mm	24 months	40 kg	227 kg



Oxford Advance Folding Hoist

- Mobile patient lifter for transfer to a seated or lying position
- Compact design can be folded easily for storage or transportation
- Epoxy powder coated frame
- Single speed handset control
- Emergency lowering
- Over-sized push handles for excellent manoeuvrability

✓ DVA CONTRACTED
 AM01.....HIRE (P.A Rqd)
 Prescribers... Phys/OT/RN/S/LMO
 For approval rules refer to pg 7.

- Manual foot operated leg gating and tapered leg design for close access
- Suits a large range of patient slings
- Supplied with battery and charger



Code	Description	Length	Width	Height	Leg Gate	Lift Range	Warranty	Product Weight	Max. User Wt.	✓ RAP #:
LSS377300	Advance Folding Hoist	1300 mm	670 mm	1360 mm	570 - 1000 mm	350 - 1860 mm	24 months	31.7 kg	154 kg	AM01



Stature Hoist

- The Stature lift recognises the true needs of the modern care environment, able to cope with even the most demanding and technical of patient handling situations
- Safe working load of 227 kgs and great lifting ranges available (min 390 mm, max 1550 mm)
- The Stature can lift patients from the floor as well as accommodate transfers to higher surfaces, while allowing the choice of different sling systems
- Careful attention to product design ensures correct ergonomic usage, protecting both the patient and caregiver from injury
- Manual or powered cradles are available to assist with repositioning of patients
- The powered base allows the caregiver to open and close the legs without bending or twisting
- Ergonomic foot push-pad to assist with initiating movement

Code	Description	Length	Width	Height	Leg Gate	Lift Range	Warranty	Product Weight	Max. User Weight
LSS377373	Stature Hoist	1390 mm	1360 mm	2130 mm	640 - 1230 mm	390 - 1550 mm	24 months	73.5 kg	227 kg



Journey Folding Standing Lifter

- Mobile compact patient lifter for transfer to a seated, lying or standing position
- Compact and lightweight allowing carers to manoeuvre in tight spaces
- Folds away for easy storage or transportation
- Unique adjustable 'cow-horn' shape supports a wide range of patient heights and sizes
- Adjustable knee pad
- Epoxy coated frame

✓ DVA CONTRACTED
 AM01..... HIRE (P.A Rqd)
 Prescribers... Phys/OT/RN/S/LMO
 For approval rules refer to pg 7.

- Electric hand control operation
- Emergency operation
- Easily manoeuvrable with 125 mm rear locking castors and 75 mm front twin swivel castors
- Electric leg gating
- Supplied with battery and charger

Code	Model	Length	Width	Height	Leg Gate	Lift Range	Warranty	Product Weight	Max. User Wt.	✓ RAP #:
LSS377305	Journey Standing Lifter	1000 mm	685 mm	1600 mm	590 - 875 mm	720 - 1530 mm	24 months	40.2 kg	155 kg	AM01



Elevate Standing Lifter

- The Elevate is a high performance active lift designed to improve the lifting experience for both the caregiver and the patient
- It is both compact and sturdy with a safe working load rating of 200 kgs
- Integrated digital weigh-scale assist with patient monitoring, designed with intuitive controls that require very little product training for caregivers

- The foot-tray is angled and utilises a lightweight plastic cover that can be easily removed for cleaning. In addition, by removing the foot-tray, the Elevate allows gait training for rehabilitation of patients
- The sculpted kneepad can be easily adjusted to improve patient comfort

Code	Model	Length	Width	Height	Leg Gate	Lift Range	Warranty	Product Weight	Max. User Weight
LSS377302	Elevate Standing Lifter	1100 mm	630 mm	1700 mm	510 - 870 mm	946 - 1640 mm	24 months	62 kg	200 kg

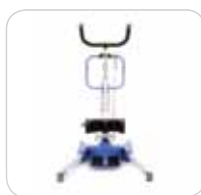

Ascend Standing Lifter

- With its great range of movement, the Ascend can transfer a patient from a low-seated position to fully extended with ease
- The Ascend is compact and easy to manoeuvre in confined spaces such as bathrooms and has many key design features that make it a truly flexible piece of equipment
- Its active lifting motion has been designed to encourage user participation, which ultimately promotes patient independence and well-being

- The kneepad can be adjusted within a 150 mm operating range to improve patient comfort during repositioning
- The removable foot tray allows the Ascend to be used as a walking aid - great for patients that require gait-training
- Ergonomic foot pad to assist with initiating movement
- Careful attention to product design ensures correct ergonomic usage, protecting both the patient and carer from injury at all times

Code	Model	Length	Width	Height	Leg Gate	Lift Range	Warranty	Product Weight	Max. User Weight
LSS377350	Ascend Standing Lifter	1100 mm	630 mm	1710 mm	510 - 885 mm	990 - 1665 mm	24 months	47 kg	170 kg

Manual Handling - Lifters & Slings



Oxford Pivot Frames

- The 4-point positioning cradle uses the Securi3 safety clip system and adjustment is made by rotating the cradle handle either down or up to obtain an upright or reclined position for the patient
- Both manual and powered cradles are available

DVA For eligibility & prescriber info please refer to pg 7.

Code	Description	RAP #:
LSS377395	Pivot Frame 4 Point	AM01
LSS377385	Pivot Frame 4 Point with Digital Weigh Scale	-
LSS377397	Pivot Frame 4 Point Powered	-



LSS377385



LSS377397



Standing Sling

- The standing sling is suitable for those patients who have a greater degree of weight bearing ability
- It allows excellent access for toileting and is easy to fit, providing quick and effective transfers
- The adjustable waist strap and the non-slip back pad ensures the sling does not ride up during the transfer

DVA For eligibility & prescriber info please refer to pg 7.

Code	Description	RAP #:
LSS371952	Standing Sling Small	AM02
LSS371951	Standing Sling Medium	AM02
LSS371950	Standing Sling Large	AM02

- This sling can be unsafe however, when used with the wrong patient, so a careful risk assessment is advised
- Available in three sizes - small, medium and large
- FIM Scores: 3 and 4



Quickfit Deluxe

- This sling is a development of the Quickfit design and is suitable for 95% of patients
- It can be used for amputees following assessment, and is available in sizes XS to XL
- FIM Scores: 1 and 2 and any other person from the floor

Code	Description
SL100IC	Quickfit Sling Deluxe Mesh Small
LSS371700	Quickfit Sling Deluxe Mesh Medium
LSS371703	Quickfit Sling Deluxe Mesh Large
SL1050	Quickfit Deluxe Poly Small
LSS371632	Quickfit Deluxe Poly Medium
SL105C	Quickfit Deluxe Poly Large

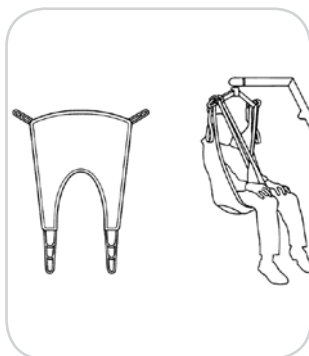

Quickfit

- This sling is an easy-to-fit, general-purpose sling designed to suit 85% of patients.
- It is simple to use and is available in sizes XS to XL
- FIM Scores: 1 and 2 and any other person from the floor

Code	Description
SL1000DC	Quickfit Poly Padded Small
LSS371628	Quickfit Poly Padded Medium
SL10006P	Quickfit Poly Padded Large



Quickfit Access Toileting

- This sling is designed specifically to facilitate the toileting procedure by allowing the removal of clothing
- It is NOT a general-purpose sling and will suit only 25% of patients
- Patients must be in a sitting position to use this sling
- FIM Scores: 2 or 3 following careful assessment

Code	Description
LSS371966	Quickfit Access Toileting Medium



Long Seat Sling

- This sling can only be put on or removed in a lying position and is most commonly used with an amputee
- This sling also needs to be used in conjunction with side suspenders
- FIM Scores: 1 or 2 following careful assessment

Code	Description
SL1101	Long Seat Sling Mesh Small
SL1104	Long Seat Sling Mesh Medium
SL1107	Long Seat Sling Mesh Large
SL1100	Long Seat Sling Poly Small
SL1103	Long Seat Sling Poly Medium
SL1106	Long Seat Sling Poly Large

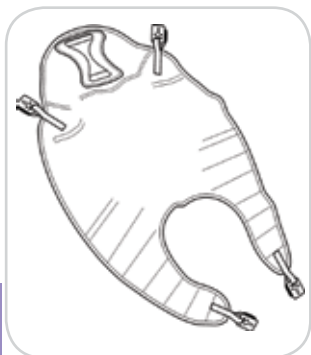

Comfort Sling

- This is a more specialised sling.
- It allows correct positioning to be made via the 4-point cradle and uses the Securi3 sling connection system ensuring no inadvertent detachment of the sling from the cradle
- It incorporates a removable comfort pad for head support and fits snugly to give full protection for patients who go into extension

Code	Description
SL25501	Comfort Sling Polyester X-Small
SL25502	Comfort Sling Polyester Small
SL25503	Comfort Sling Polyester Medium
SL25504	Comfort Sling Polyester Large
SL25505	Comfort Sling Polyester X-Large

or have involuntary movements or behavioural problems. It is available in all sizes from XS to XL

- FIM Scores: 1 and 2 and any other person from the floor

Specialty Lifters

Aidacare stock a wide range of 'Specialty Lifters' for your every need.

1. Ceiling track systems - temporary, semi-permanent/permanent
2. Portable overhead lift units
3. Pool Lifters
4. Stair Lifters
5. Wheelchair Lifters



Aidacare Home Modification Services

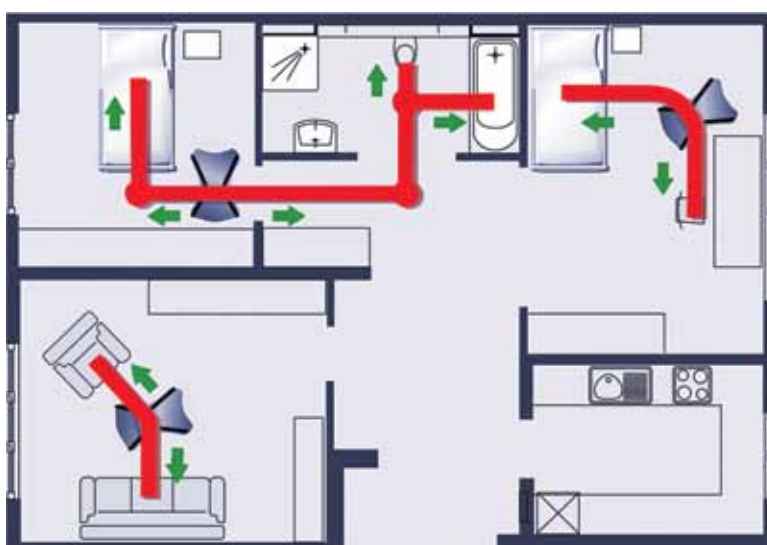

Call us for your free measure and quote!



Specialty Lifters (cont)



P.R.King & Sons Wheelchair Lifts



Stannah Indoor Stairlift

Stannah Outdoor Stairlift

Garaventa Xpress II Wheelchair Platform Lift



Garaventa Artira with Wheelchair Platform

Terry Step Lift 1000

Garaventa Genesis

Call us for your free measure and quote!

Aidacare Online

For all of your product enquiries in one user-friendly site visit us online at www.aidacare.com.au

- New product releases - updated daily
- Clear and concise product descriptions and specifications
- Contract specific ordering information (DVA, TAC & MASS)
- Downloadable DVA RAP and other order forms
- Full colour product images
- Information on our range of service offerings
- Newsletter subscription page

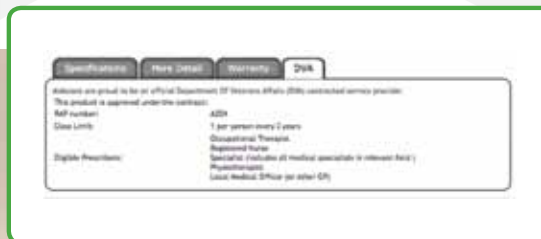

"We care for your care"



Manual Handling - Other



P 151 Transfer Boards

P 152 Transfer Walk Belts



SallyBoards

- The SallyBoard is a lightweight patient transfer board packed full of unique features
- 3 handles on each side for ease of manoeuvring
- Smooth top surface and curved edges for easy patient transfer
- 4 grip strips on underside to keep board in place



TSE672191

DVA For eligibility & prescriber info please refer to pg 7.

Code	Description	Width	Length	Product Weight	Max. User Weight	RAP #
TSE672195	SallyBoard - Medium	580 mm	1500 mm	3.8 kg	300 kg	AP09
TSE672196	SallyBoard - Large	580 mm	1800 mm	4.6 kg	300 kg	AP09
TSE672191	SallyBoard Curved	222 mm	770 mm	1.4 kg	130 kg when gap is 20 - 30 cm. 180 kg when gap less than 20 cm	AP09



The Slider

- Facilitates sliding patient transfers from wheelchair to car seat, chair, bed etc
- Strong polycarbonate is low friction surface to allow the client to transfer easily
- Reduces strain on user and carer
- Reversible plastic wheel cover designed to fit over the wheel of a wheelchair
- Max. User Weight: 150 kg



The Slider No Cut Out

- Facilitates sliding patient transfers from wheelchair to car seat, chair, bed etc
- Reduces strain on user and carer
- Ideal for a variety of transfer scenarios
- Strong polycarbonate is low friction surface to allow the client to transfer easily
- Warranty: 12 months
- Max User Weight 150 kg

DVA For eligibility & prescriber info please refer to pg 7.

Code	Description	Width	Length	RAP #
TSE672800	The Slider Small	350 mm	540 mm	AP09
TSE672790	The Slider Medium	300 mm	645 mm	AP09
TSE672780	The Slider Large	360 mm	645 mm	AP09

DVA For eligibility & prescriber info please refer to pg 7.

Code	Description	Width	Length	Product Weight	RAP #
TSE672810	The Slider No Cut Out	230 mm	610 mm	1.10 kg	AP09



Transfer Board Curved

- Facilitates patient transfers from wheelchair to car seat, chair, bed etc
- Two slip resistant pads provide stability during transfer
- Arc shape enables a variety of positioning options and allows for natural sweeping pattern of an assisted transfer
- Waterproof so ideal for bathroom transfers
- Reduces strain on user and carer



Transfer Board Curved Q2

- 285 kg weight rating meets the needs of most patients in most transfer situations greatly reducing the purchasing risk for healthcare staff
- Unique shape facilitates face to face transfers in confined areas
- Two ergonomic handles to easily transport and manoeuvre

DVA For eligibility & prescriber info please refer to pg 7.

Code	Description	Width	Length	RAP #
TSE672920	Transfer Board Curved	370 mm	710 mm	AP09

DVA For eligibility & prescriber info please refer to pg 7.

Code	Description	Width	Length	Max. User Weight	RAP #
TSE672192	Transfer Board Curved Q2	338 mm	750 mm	285 kg	AP09



One Way Seating Aid

- Assists in the correct positioning of a person in the back of a chair, prevents them slipping forward
- Non slip outside cover reduces the need for lap straps
- Reduces the risk of strain or injury from fall or slip
- Helps maintain posture for the user
- Machine washable



One Way Slide

- Assists in the correct positioning of a person in the back of a chair, prevents them slipping forward
- Reduces the risk of strain or injury from fall or slip
- Helps maintain posture for the user
- Soft and comfortable open velour design
- Machine washable

DVA For eligibility & prescriber info please refer to pg 7.

Code	Description	Width	Length	RAP #
TSE672520	One Way Seating Aid	450 mm	430 mm	AP09

DVA For eligibility & prescriber info please refer to pg 7.

Code	Description	Width	Length	RAP #
TSE672521	One Way Slide	370 mm	430 mm	AP09



Walk Belt

- Assists the carer in patient mobility and transport
- Reduces risk of strain or injury to carer
- Easily adjustable buckle system and non slip material to increase user safety
- Padded handles for carer comfort

DVA For eligibility & prescriber info please refer to pg 7.

Code	Description	Size	RAP #
TSE672040	Walk Belt Small	630 - 1140 mm	AP09
TSE672030	Walk Belt Large	1010 - 1570 mm	AP09



SallyStrap

- SallyStrap is a lightweight strap used to assist patients to stand and walk, especially frail, elderly and unreliable patients ideal for use at home or in facilities
- Max User Weight: 150kg
- Warranty: 12 months

DVA For eligibility & prescriber info please refer to pg 7.

Code	Description	Length	Width	RAP #
TSE672193	SallyStrap Small	1300 mm	50 mm	AP09
TSE672194	SallyStrap Large	1700 mm	50 mm	AP09



Transfer Belt Padded

- Assists the carer in patient mobility and transport, padded for user comfort
- Reduces risk of strain or injury to carer
- Adjustable and with nylon buckle to suit user requirements

DVA For eligibility & prescriber info please refer to pg 7.

Code	Description	Waist	RAP #
TSE673200	Transfer Belt Padded Small	750 - 850 mm	AP09
TSE673190	Transfer Belt Padded Medium	850 - 950 mm	AP09
TSE673180	Transfer Belt Padded Large	950 - 1050 mm	AP09



Slide Sheet

- Nylon material designed to assist in sliding and transferring patients
- Low friction qualities for ease of transfer
- Folded over and placed under the patient, top sheet slides on lower sheet

DVA For eligibility & prescriber info please refer to pg 7.

Code	Description	Dimensions	RAP #
TSE673070	Slide Sheet	1.0 x 1.5 m	AP09
TSE673080	Slide Sheet	2.0 x 1.5 m	AP09



Turning Sheet

- The Slide & Turn Sheet makes turning patients in bed much easier
- Log rolling patients is avoided by using the Slide & Turn Sheet
- This special breathable sheet is placed on the bed and stays in position

DVA For eligibility & prescriber info please refer to pg 7.

Code	Description	Length	Width	RAP #
TSE672740	Turning Sheet Small	1630 mm	1450 mm	AP09
TSE672750	Turning Sheet Large	1750 mm	1450 mm	AP09



Evacuation Sheet

- Assists in the quick and safe evacuation of non-ambulant patients
- Helps carers or nurses or rescue teams slide the mattresses along carpet or vinyl, increasing patient safety and preventing injury to nursing staff

DVA For eligibility & prescriber info please refer to pg 7.

Code	Description	Width	Length	RAP #
TSE672525	Evacuation Sheet	480 mm	187 mm	AP09



Easy Turn

- Padded rotating seat useful for transfers from wheelchair to car seat etc
- Reduces strain on user and carer backs
- Padded for comfort during transfers and while seated
- Swivel mechanism provides smooth action
- Can also be used on an armless chair

DVA For eligibility & prescriber info please refer to pg 7.

Code	Description	RAP #
TSE672580	Easy Turn	AP09



Patient Turntable

- Swivel platform to assist in standing rotational transfers
- Ideal for transfers in a variety of situations such as cars, wheelchairs and household areas
- Reduces risk of torquing injuries from pivoting motion
- Swivels 360 degrees with a smooth and safe turning action

Code	Description	Warranty
TSE672770	Patient Turntable	12 months



Rota Seat

- Padded rotating seat useful for transfers from wheelchair to car seat etc
- Swivels 360 degrees and has a smooth turning action
- Reduces strain on user and carer backs
- Padded for comfort during transfers and while seated



Standing Patient Turner - Orbi-turn

- The Orbi-turn has been designed for carers to facilitate standing and seat-to-seat transfers
- It allows a patient with moderate upper and lower limb strength to participate in functional transfers whilst ensuring good working postures for carers and therapists

Code	Description	Seat Diameter	Warranty	Product Weight	Max. User Weight
TSE672860	Rota Seat	350 mm	12 months	2.4 kg	100 kg

Code	Description	Max. User Weight
TSE672935	Standing Patient Turner - Orbi-turn	190 kg

Aidacare Online

For all of your product enquiries in one user-friendly site visit us online at www.aidacare.com.au

- New product releases - updated daily
- Clear and concise product descriptions and specifications
- Contract specific ordering information (DVA, TAC & MASS)
- Downloadable DVA RAP and other order forms
- Full colour product images
- Information on our range of service offerings
- Newsletter subscription page

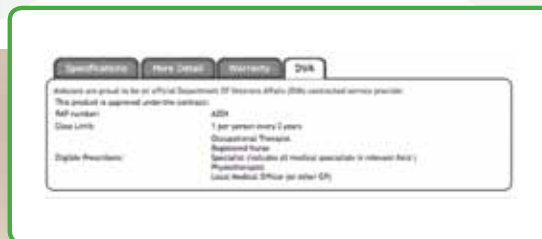

"We care for your care"



Mobility Scooters



- P 155** Mobility Scooters
- P 159** Scooter Servicing
- P 160** Scooter Accessories



Go-Go Travel Scooters

- Lightweight mobility scooter
- Disassembles into 5 pieces for easy transportation and storage (refer to image)
- Available in 3 or 4 wheel configuration
- Comfortable front-mounted post seat with arm rests for stability
- Easy to remove rechargeable battery
- Soft and easy to adjust tiller
- Flat free tyres
- Includes 3 sets of easily changeable colours (Red, Blue, Silver)
- Note: Pictured is the Go Go Elite 4 Wheel Scooter
- Front basket standard

✓ DVA CONTRACTED

AP05..... HIRE (P.A Rqd)
Prescribers... OT/S/LMO

For approval rules refer to pg 7.

'KEEP YOUR SCOOTER SCOOTING'
BOOK AN ANNUAL SERVICE



5 Pieces



Code	Description	Length	Width	Max. Speed	Product Weight	Warranty	Max. User Weight	RAP #:
SCT670610	Go-Go Ultra X 4 Wheel	1010 mm	495 mm	Up to 6 km/h	35.5 kg (w/out batteries)	24 months (6months batteries)	118 kg	AP05
SCT670600	Go-Go Ultra X 3 Wheel	930 mm	495 mm	Up to 6 km/h	34 kg (w/out batteries)	24 months (6months batteries)	118 kg	AP05
Elite Travel	Elite Travel Plus	1010 mm	540 mm	Up to 6 km/h	39.5 kg (w/out batteries)	24 months (6months batteries)	147 kg	-



Celebrity X

- High performance mobility scooter
- Ideal for outdoor use
- Comfortable front-mounted post seat with high back and arm rests for stability
- State of the art rear suspension
- Wrap around easy drive tiller with modern LED headlight
- Available in 3 or 4 wheel configuration
- 159kg load capacity
- Front basket standard

✓ DVA CONTRACTED

AP05..... HIRE (P.A Rqd)
Prescribers... OT/S/LMO

AP21..... BUY (P.A Rqd)
Prescribers... Phys/OT/Ch/Ost/S/LMO

For approval rules refer to pg 7.

'KEEP YOUR SCOOTER SCOOTING'
BOOK AN ANNUAL SERVICE



Rear Bag



Flag



Mirror



Sheepskin Cover

Code	Description	Length	Width	Max. Speed	Product Weight	Warranty	Max. User Weight	RAP #:
SCT670570	Celebrity X 4 Wheel	1190 mm	610 mm	Up to 9.5 km/h	79 kg (w/out batteries)	24 months (6months batteries)	159 kg	AP05
SCT670560	Celebrity X 3 Wheel	1170 mm	610 mm	Up to 9.5 km/h	64 kg (w/out batteries)	24 months (6months batteries)	159 kg	AP05
SCA668190	Front Basket - Celebrity X							AP21
SCA668400	Sheepskin Cover - Celebrity X							-



Celebrity DX

- High performance mobility scooter
- Ideal for outdoor use
- Deluxe front-mounted high back swivel seat with headrest and arm rests for stability
- Lumbar support and manual recline for increased comfort
- State of the art rear suspension
- Unique easily adjusted steering mount with modern LED headlight & indicator lights
- Auto latching lockup for quick assembly and dismantling
- 159kg load capacity
- Front basket standard
- Hazard lights



Rear Bag



Flag



Mirror



Sheepskin Cover

Code	Description	Length	Width	Max. Speed	Product Weight	Warranty	Max. User Weight	RAP #:
SCT670530	Celebrity DX 4W	1190 mm	610 mm	Up to 9.5 km/h	77 kg (w/out batteries)	24 months (6months batteries)	159 kg	AP05
SCT670520	Celebrity DX 3W	1190 mm	610 mm	Up to 9.5 km/h	77 kg (w/out batteries)	24 months (6months batteries)	159 kg	-

✓ DVA CONTRACTED
AP05..... HIRE (P.A Rqd)
Prescribers... OT/S/LMO
For approval rules refer to pg 7.

'KEEP YOUR SCOOTER SCOOTING'
BOOK AN ANNUAL SERVICE

⚠ Safety Note: Ask us for a copy of 'Help Cut Mobility Scooter Accidents' for some great scooter safety and selection tips.



Celebrity Deluxe XL

- High performance mobility scooter
- Large knobby tyres for excellent outdoor traction
- Deluxe front-mounted high back swivel seat with headrest and arm rests for stability
- Lumbar support and manual recline for increased comfort
- State of the art rear suspension
- Unique easily adjusted steering mount with modern LED lighting
- Auto latching lockup for quick assembly and dismantling
- Rear view mirror and full directional lighting package including front and rear turn signal indicators
- 159kg load capacity
- Front basket standard



Rear Bag



Flag



Mirror



Sheepskin Cover

Code	Description	Length	Width	Max. Speed	Product Weight	Warranty	Max. User Weight
SCT670540	Celebrity Deluxe XL Red	1300 mm	640 mm	Up to 12 km/h	91 kg (w/out batteries)	24 months (6months batteries)	159 kg

'KEEP YOUR SCOOTER SCOOTING'
BOOK AN ANNUAL SERVICE

⚠ Safety Note: Ask us for a copy of 'Help Cut Mobility Scooter Accidents' for some great scooter safety and selection tips.



Pathrider 10

- High performance sleek and sporty powered mobility scooter
- Low profile, puncture proof tyres
- Back lit battery gauge
- Wrap around easy drive tiller
- Comfortable front-mounted post seat with arm rests for stability
- Easy to remove rechargeable battery
- 159kg load capacity
- Front basket standard

✓ DVA CONTRACTED

AP05..... HIRE (P.A Rq'd)
Prescribers... OT/S/LMO

For approval rules refer to pg 7.

'KEEP YOUR SCOOTER SCOOTING'
BOOK AN ANNUAL SERVICE

⚠ Safety Note: Ask us for a copy of 'Help Cut Mobility Scooter Accidents' for some great scooter safety and selection tips.



Flag



Dust Cover



Sheepskin Cover

Code	Description	Length	Width	Max. Speed	Product Weight	Warranty	Max. User Weight	RAP #:
SCT670615	Pathrider 10	1190 mm	565 mm	Up to 8.5 km/h	63.5 kg (w/out batteries)	24 months (6months batteries)	159 kg	AP05



Pathrider 10 DX

- High performance sleek and sporty powered mobility scooter
- Low profile, puncture proof tyres
- Comfortable front - mounted post seat with arm rests for stability
- Rugged front and rear suspension
- Automatic high visibility front and rear lighting
- Long lasting high intensity LED headlight, tail light and indicators
- Back-lit battery gauge on monitor
- Wrap around easy drive tiller
- Tiller mounted battery charger port for off board charger

✓ DVA CONTRACTED

AP05..... HIRE (P.A Rq'd)
Prescribers... OT/S/LMO

For approval rules refer to pg 7.

'KEEP YOUR SCOOTER SCOOTING'
BOOK AN ANNUAL SERVICE

- Pathrider 10 (SCT670615) is the mid size scooter option with low back seat
- 159kg load capacity
- Front basket standard



Flag



Dust Cover



Sheepskin Cover

Code	Description	Length	Width	Max. Speed	Product Weight	Warranty	Max. User Weight	RAP #:
SCT670620	Pathrider 10 DX	1187 mm	565 mm	Up to 8.5 km/h	84 kg (w/out batteries)	24 months (6months batteries)	159 kg	AP05



Pathrider 130 XL

- High performance sleek and sporty powered mobility scooter
- Large 13" low profile wheels to handle rugged outdoor terrain
- Deluxe suspension seat with arm rests, head rest and lumbar support for stability
- Rugged front and rear suspension
- Automatic full lighting system including directional adjustment
- Long lasting high intensity LED kerb light, headlight, tail light and indicators
- Back-lit battery gauge on monitor
- Wrap around easy drive tiller
- Tiller mounted battery charger port for off board charger



Rear Basket



Rear Bag



Dust Cover



Flag

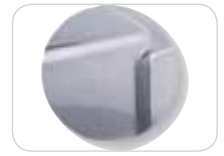

Silver

DVA CONTRACTED
AP05..... HIRE (P.A Rqd)
Prescribers... OT/S/LMO
For approval rules refer to pg 7.

'KEEP YOUR SCOOTER SCOOTING'
BOOK AN ANNUAL SERVICE

⚠ Safety Note: Ask us for a copy of 'Help Cut Mobility Scooter Accidents' for some great scooter safety and selection tips.

Code	Description	Length	Width	Max. Speed	Product Weight	Warranty	Max. User Weight	RAP #:
SCT670572	Pathrider 130XL Red	1352 mm	640 mm	Up to 12 km/h	97.5 kg (w/out batteries)	24 months (6months batteries)	181 kg	AP05
SCT670574	Pathrider 130XL Silver	1352 mm	640 mm	Up to 12 km/h	97.5 kg (w/out batteries)	24 months (6months batteries)	181 kg	-



Pathrider 140 XL

- Top of the range sleek and sporty powered mobility scooter
- Large 13" pneumatic tyres to handle rugged outdoor terrain
- Luxurious suspension seat with arm rests, head rest and lumbar support for stability
- Rugged front and rear suspension and sealed hydraulic brakes
- Automatic full lighting system including directional adjustment
- Long lasting high intensity LED kerb light, headlight, tail light and indicators
- Back lit battery gauge
- Wrap around easy drive tiller
- Tiller mounted battery charger port for off board charger



Rear Bag



Dust Cover



Flag



Silver

'KEEP YOUR SCOOTER SCOOTING'
BOOK AN ANNUAL SERVICE

⚠ Safety Note: Ask us for a copy of 'Help Cut Mobility Scooter Accidents' for some great scooter safety and selection tips.

Code	Description	Length	Width	Max. Speed	Product Weight	Warranty	Max. User Weight
SCT670578	Pathrider 140XL Yellow	1428 mm	692 mm	Up to 15 km/h	117.70 kg (w/out batteries)	24 months (6months batteries)	181 kg
SCT670576	Pathrider 140XL Red	1428 mm	692 mm	Up to 15 km/h	117.70 kg (w/out batteries)	24 months (6months batteries)	181 kg
SCT670577	Pathrider 140XL Silver	1428 mm	692 mm	Up to 15 km/h	117.70 kg (w/out batteries)	24 months (6months batteries)	181 kg



**'KEEP YOUR
SCOOTER SCOOTING'**
BOOK AN ANNUAL SERVICE

WE RECOMMEND
YOU SERVICE YOUR
SCOOTER EVERY
12 MONTHS

Scooter Servicing

Aidacares team of trained service technicians are on hand to perform a full service on your scooter.

Our team are authorised Pride agents so you can be sure only quality parts will be used and your warranty will be retained.

Call us today to book your scooter in.



THE AIDACARE SERVICE DEPARTMENT STOCK A FULL RANGE OF SPARE SCOOTER PARTS.

Batteries & Chargers		GOGO Elite	Pathrider 10	Celebrity X 3W	Celebrity X 4W	Celebrity DX 4W	Celebrity XL	Pathrider 10 DX	Pathrider 130 XL	Pathrider 140 XL
Code	Description									
MBT401480	Battery 18 Amp	✓								
GSP	Battery 35 Amp		✓	✓	✓	✓				
MBT401290	Battery 40 Amp						✓	✓		
GSP	Battery 55 Amp								✓	✓
MBT401575	Battery Charger 2 Amp	✓								
MBT401580	Battery Charger 4 Amp		✓	✓	✓	✓	✓	✓		
MBT401590	Battery Charger 8 Amp								✓	✓
Tyres & Tubes		GOGO Elite	Pathrider 10	Celebrity X 3W	Celebrity X 4W	Celebrity DX 4W	Celebrity XL	Pathrider 10 DX	Pathrider 130 XL	Pathrider 140 XL
Code	Description									
MWT450070	Tyre 260mm(H)x85mm(P)x4"(R) Grey Stud Tread (260x85) (3.00-4)	Complete Solid Wheel	Complete Solid Wheel	✓	✓	✓			Complete Solid Wheel	Complete Solid Wheel
MWT450100	Tyre 250mm(H)x75mm(P)x4"(R) Grey Rib Tread (3.00 - 4)			✓	✓	✓				
MWT450160	Tyre 290mm(H)x80mm(P)x6"(R) Grey Block Tread (4.10/3.50x6)						✓			
MWT450670	Tube 260mm(H)x85mm(P)x4"(R) Bent Valve (4.10/3.5x4) (3.00-4)			✓	✓	✓				
MWT450690	Tube 290mm(H)x80mm(P)x6"(R) Bent Valve (4.10/3.5x6)						✓	✓	✓	✓



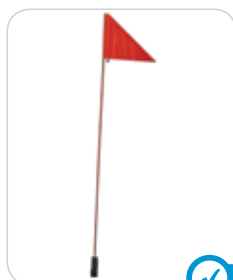

Scooter Flag

- A long flexible flag to provide increased visibility to a scooter

DVA For eligibility & prescriber info please refer to pg 7.

Code	Description	RAP #:
SCA668370	Scooter Flag	AP21



Cup Holder

- Accessory to suit all three & four wheel scooters

DVA For eligibility & prescriber info please refer to pg 7.

Code	Description	RAP #:
SCA668170	Cup Holder	



Mirror - Celebrity X & DX

- Round rearview mirror assembly for select models of Pride mobility scooters
- Assembly includes complete rearview mirror, top bracket, bottom bracket and hardware (all necessary nuts and screws)

DVA For eligibility & prescriber info please refer to pg 7.

Code	Description	RAP #:
SCA668300	Mirror - Celebrity X & DX	AP21



Rear Basket

- Handy rear storage basket, ideal for your handbag/groceries

DVA For eligibility & prescriber info please refer to pg 7.

Code	Description	RAP #:
SCA668180	Rear Basket	AP21



Sheepskin Cover - Celebrity Range

- Made from premium Australian Sheepskin
- Easy to fit and removable for ease of cleaning
- Maximises comfort

DVA For eligibility & prescriber info please refer to pg 7.

Code	Description	RAP #:
SCA668410	Sheepskin Cover - Celebrity Range	



Dust Cover

- A strong and lightweight dust cover for scooters
- Ideal for protecting your scooter whilst undercover and not in use
- Not recommended for use as a rain cover

DVA For eligibility & prescriber info please refer to pg 7.

Code	Description	RAP #:
SCA668210	Dust Cover for Scooter	AP21



Cane Holder

- Scooter mounted walking stick holder
- Mounts directly onto the scooter tow bar (or side option)
- Please note: Picture shows Cane Holder Single Rear
- Also available in side mounted and flag holding version
- Both options come in either single or double

DVA For eligibility & prescriber info please refer to pg 7.

Code	Description	Additional	RAP #:
SCA668230	Cane Holder Single Rear		AP21
SCA668220	Cane Holder Double Rear		AP21
SCA668240	Cane Holder Double Side	Requires L Piece Accessory (SCA668390)	AP21
SCA668250	Cane Holder Single Side	Requires L Piece Accessory (SCA668390)	AP21



Golf Bag Carrier

- The golf bag holder will accommodate one golf bag and it attaches to the universal accessory holder on the back of your Pride scooter

DVA For eligibility & prescriber info please refer to pg 7.

Code	Description	RAP #:
SCA668280	Golf Bag Carrier	



L Piece Accessory

- Scooter accessory mounting equipment
 - Designed for use with the following scooter accessories
- | | |
|-------------------------|-------------|
| Cane Holder Side Single | (SCA668250) |
| Cane Holder Side Double | (SCA668240) |
| Oxygen Bottle Carrier | (SCA668330) |
| Walking Frame Holder | (SCA668390) |

DVA For eligibility & prescriber info please refer to pg 7.

Code	Description	RAP #:
SCA668310	L Piece Accessory	AP21



Oxygen Bottle Holder

- Scooter mounted oxygen bottle holder
- Carries a 406L oxygen bottle
- Fits easily into the scooter tow bar on the rear
- Can be used in conjunction with the cane holder mount
- If by itself, requires the "L" Piece Accessory (SCA668310)



Scooter Rear Bag

- Scooter bag attachment to carry bits and pieces
- Fits easily into the scooter tow bar on the rear
- Durable black tonneau material
- Comes with all mounting hardware required for installation (including L Piece Accessory)

DVA For eligibility & prescriber info please refer to pg 7.

DVA For eligibility & prescriber info please refer to pg 7.

Code	Description	Additional	RAP #:
SCA668330	Oxygen Bottle Holder	Requires L Piece Accessory (SCA668330)	AP21

Code	Description	RAP #:
SCA668340	Scooter Rear Bag	AP21
SCA668350	Crossbar With Fork For Bag	AP21
SCA668360	Black Replacement Rear Bag	AP21



Walking Frame Holder

- Scooter mounted walking frame holder
- Mounts directly onto the scooter tow bar
- Can be used in conjunction with the sun canopy
- If by itself, requires the "L" Piece Accessory (SCA668310) and anti rattle clamp (SCA668312)



Sun Canopy

- Large scooter canopy great for sun or rain protection
- Fits easily into the scooter tow bar on the rear
- Sturdy waterproof canvas
- Comes with all mounting hardware required for installation

DVA For eligibility & prescriber info please refer to pg 7.

Code	Description	Additional	RAP #:
SCA668390	Walking Frame Holder	L Piece Accessory (SCA668310) & Clamp (SCA668312)	AP21
SCA668312	Anti Rattle Clamp For Walking Frame Holder		AP21

Code	Description	Width	Length
SCA668380	Sun Canopy	600 mm	750 mm



Wind/Rain Shield

- Protects the scooter driver from the wind and rain whilst driving
- Comes with clear front shield
- Used in conjunction with sun canopy
- Aluminium frame attaches to the bumper bar and the sun canopy
- Please specify type of scooter at time of order
- Note: pictured with optional side wind shields (2 x SCA668395) and rear wind shield (SCA668396)
- Note: pictured with sun canopy which must be used for attachment (SCA668380)

Code	Description
SCA668397	Scooter Wind/Rain Shield Front Section Including Frame
SCA668392	Rain Cover for Scooter
SCA668396	Scooter Rear Wind Shield
SCA668395	Scooter Side Wind Shield (each only)

Safety Note: Ask us for a copy of 'Help Cut Mobility Scooter Accidents' for some great scooter safety and selection tips.

Scooter Safety Tips

- Driving a mobility scooter requires very good sight, strength, coordination, balance and concentration.
- Before you buy a mobility scooter, have a test run to ensure you have the strength, control and confidence to use it.
- Plan your trips using routes where you know there are footpaths.



'Help cut mobility scooter accidents', Commonwealth of Australia, 7th December 2010

Paediatric



- P 163** Strollers & Walking Frames
- P 165** Seating & Standing Aids
- P 167** Other
- P 168** Paediatric Cots



Kidwalk

- Partially weight bearing, posturally supportive mobility system which encourages mobility and moves with the child
- Child walks unaided while also keeping hands free
- Easy, tool-free set-up and adjustment
- Available in 2 sizes

Code	Description	Height of User	Overall Width	Overall Length	Warranty	Max. User Weight
PED479355	Kidwalk Size 1	610 - 1220 mm	640 mm	838 - 890 mm	24 months	29.4 kg
PED479356	Kidwalk Size 2	1010 - 1520 mm	700 mm	915 - 965 mm	24 months	49.8 kg



Nurmi Neo Walking Aid

- Innovative walking aid for children
- Positioned behind the child's body whilst walking allowing open directional walking
- Lightweight folding frame is height adjustable to grow with the user
- Includes reverse roll locks and swivelling front castors
- Options available to customise the frame to the individual user
- Available in 3 sizes

Code	Description	Warranty
PED479349	Nurmi Neo Walking Aid	24 months



Kimba Spring Stroller

- Indoor or outdoor stroller for children requiring postural support
- Built-in suspension ensures a smooth ride outdoors
- Easy-to-use, unique folding system for easy transportation or storage
- Includes height-adjustable push handle, angle-adjustable backrest plus tilt-in-space
- A number of seating support accessories available

Code	Description	Seat Width	Seat Depth	Back Height	Seat to Footrest	Warranty	Max. User Weight
PED478438	Kimba Size 1, Ages 1-6 years	200 - 300 mm	190 - 310 mm	460 - 660 mm	190 - 310 mm	24 months	35 kg
PED478439	Kimba Size 2, Ages 4-10 years	260 - 350 mm	240 - 400 mm	570 - 700 mm	200 - 370 mm	24 months	35 kg



Kiwi Stroller

- Lightweight rehab buggy for children with moderate needs
- Simple to use, easy to push and offers total flexibility
- Push bar can be reversed in one easy step
- Seat tilt and back angle adjustment in three steps as standard
- Range of positioning accessories available
- Two sizes available and suitable for children ages 1 to 6

Code	Description	Seat Width	Seat Depth	Back Height	Warranty	Max. User Weight
PED478435	Kiwi Size 1	270 mm	120 - 220 mm	630mm	24 months	25 kg
PED478436	Kiwi Size 2	320 mm	200 - 280 mm	680 mm	24 months	25 kg



EZ rider

- Ultra lightweight compact folding stroller
- 10 degree seat tilt allows correct positioning for children needing postural support, but also keeps them sitting upright
- Seating accessories include headrests, torso supports and tray
- Available as crash tested Bus Transport model
- Bus Transport model comes standard with tie-down system, H-Harness, headrest extension, and foot straps
- Available in 4 different seat widths

Code	Description	Seat Width	Seat Depth	Back Height	Seat to Footrest	Product Weight	Warranty	Max. User Weight
PED477700	EZ Rider	305 - 455 mm	280 - 445 mm	451 - 508 mm	90 - 508 mm	11.4 - 13.2 kg	Lifetime Limited	30 - 114 kg



Cruiser

- Lightweight compact folding stroller
- Set at 30 degrees seat tilt to allow for more postural support
- Seating accessories include headrests, torso supports and tray
- Available as crash tested Bus Transport model
- Bus Transport model comes standard with tie-down system, H-Harness, headrest extension, and foot straps
- Available in 5 different seat widths

Code	Description	Seat Width	Seat Depth	Back Height	Seat to Footrest	Warranty	Product Weight	Max. User Weight
PED477260	Cruiser	255 - 455 mm	230 - 480 mm	533 - 630 mm	130 - 580 mm	Lifetime Limited	8.6 - 13.6 kg	66 - 77 kg



Rodeo Tilt

- Versatile Tilt-In-Space stroller
- Compact folding and lightweight design for easy transporting
- Available as crash tested Bus Transport model
- Bus Transport model comes standard with tie-down system, H-Harness, headrest extension, and foot straps
- Available in 3 seat widths

Code	Description	Seat Width	Seat Depth	Back Height	Seat to Footrest	Product Weight	Warranty	Max. User Weight
PED478195	Rodeo Tilt	305 - h05 mm	280 - 460 mm	584 - 690 mm	200 - 440 mm	10.5 - 14 kg	Lifetime Limited	30 - 77 kg



Totstander

- Totstander is designed to suit children at early stages of standing
- Often used as an assessment tool
- Available with adjustable pelvic belt, chest strap, knee cups and sandals
- Highly portable

Code	Description	User Standing Height	Chest Pad Height	Max. User Weight
PED479240	Totstander	750 - 900 mm	470 - 640 mm	25 kg



Squiggles Standing System

- Squiggles Standing System supports the child in a comfortable, secure, upright, prone or supine standing posture
- Chassis can clip on and off in seconds for folding and storage
- Adjustable to accommodate children with differing needs
- Accessories available include tray, knee blocks, supports, headrests which all attach without tools

Code	Description	User Standing Height	Chest Pad Height	Max. User Weight
PED479379	Squiggles Stander 1-5 years	750 - 1100 mm	550 - 820 mm	22 kg



Pronestander

- Assists in standing and weight bearing development
- Adjustable in 4 forward prone positions up to 40 degrees
- Highly adjustable to suit individual users
- Includes chest and knee supports, hip belt, angle adjustable tray and activity bowl
- Mobility base has 4 locking castors for stability

Code	Description	User Standing Height	Chest Pad Height	Max. User Weight
PED479250	Pronestander Size 1, 1.5-5 years	800 - 1150 mm	470 - 680 mm	60 kg
PED479260	Pronestander Size 2, 4-10 years	1100 - 1450 mm	680 - 975 mm	80 kg
PED479270	Pronestander Size 3, 9-18 years	1400 - 1850 mm	975 - 1350 mm	90 kg



Freestander

- Upright stander designed to assist in standing and weight bearing development
- Highly adjustable to suit individual users
- Includes chest and knee supports, hip belt, angle adjustable tray and activity bowl
- Mobility base with 4 locking castors

Code	Description	User Standing Height	Chest Pad Height	Max. User Weight
PED479170	Freestander Size 1, 1-5 years	800 - 1150 mm	525 - 850 mm	60 kg
PED479180	Freestander Size 2, 4-9.5 years	1100 - 1450 mm	680 - 1100 mm	80 kg
PED479190	Freestander Size 3, 9-17 years	1400 - 1850 mm	975 - 1425 mm	90 kg



Horizon

- Unique powered standing frame available as either a prone or supine setup
- Easily changeable from either prone or supine setups
- Fully adjustable to suit individual user setups and is ideal in multi user environments
- Available with headrest, adjustable sandals, lateral supports and pelvic positioning belt

Code	Description	User Standing Height	Chest Pad Height	Max. User Weight
PED479105	Horizon Size 1, 4-10 years	1000 - 1400 mm	820 - 1150 mm	50 kg
PED479130	Horizon Size 2, 10-18 years	1400 - 1800 mm	1000 - 1450 mm	80 kg



Early Sitting System

- The Early Sitting System is designed to encourage children up to 48 months to develop sitting balance.
- The dynamic trunk support of this lightweight, portable seat allows upper body movement.
- Can be set up for dynamic sitting, prone sitting and long sitting and can even be strapped to a normal dining table chair.

Code	Description	Weight Capacity	Width Between Arms	Seat Depth	Backrest Height	User Height
GSP	Early Sitting System	17 kg	150 to 200 mm	190 to 260 mm	100 mm	800 to 1000 mm



Corner Sitter

- Helps to promote long sitting for children
- Large, adjustable side wings provide increased lateral support
- Backrest can be adjusted to the prone 15 degrees and supine 20 degrees position
- Includes a pelvic positioning belt plus depth adjustable pommel for ideal seating
- Folds flat for easy storage
- Accessories include tray and contoured headrest

Code	Description	Hip Width	Seat Depth	Backrest Height	Max. User Weight
PED478680	Corner Sitter Size 1, 1.5-6 years	380 mm	335 mm	300 mm	30 kg
PED478690	Corner Sitter Size 2, 5-9 years	425 mm	460 mm	400 mm	40 kg
PED478700	Corner Sitter Size 3, 8-14 years	475 mm	550 mm	500 mm	50 kg



PAL Classroom Seat

- Pal is an attractive, robust and easy to use classroom and nursery seating system for kids of 1-8 years of age, with mild to moderate postural needs.
- It is designed to give improved stability, which helps reduce fatigue and allows the child longer periods of concentration and fine motor activity.
- Available in 3 sizes and 4 colours it will help kids up to 8 years of age to participate, learn and give their full attention in the classroom
- Warranty: 24 months

Code	Description	Seat Width	Seat Depth	Backrest Height	Max. User Weight
PED478800	PAL Classroom Seat	150 - 330 mm	180 - 330 mm	265 - 380 mm	30 - 40 kg



Easy Seat

- Sturdy height-adjustable chair provides postural support for children with positioning needs
- Ideal for the school or home environment
- Seat width and depth adjustment allows for growth in the chair
- Can be converted to a potty trainer
- Large range of accessories available

Code	Description	Hip Width	Seat Depth	Backrest Height	Max. User Weight
PED478840	Easy Seat Size 1, 1-3 years	125 - 225 mm	175 - 250 mm	225 - 285 mm	30 kg



Squiggles Seating System

- Squiggles Seating System is designed for children requiring postural support
- Adjustable seating system with tilt in space mechanism
- Designed to suit children from 6 months to 5 years and allows for growth
- Can be ordered with a choice of base including wheelchair base, stroller base or high low indoor base
- Seating accessories include thoracic supports, sandals, tray, harness plus others

Code	Description	Seat Width	Seat Depth	Backrest Height	Max. User Weight
PED479369	Squiggles Seating System	60 - 220 mm	190 - 290 mm	320 - 380 mm	22 kg



Mygo Seating System

- Multifunctional seating system designed for children and adolescents requiring moderate postural support
- Available in two sizes: For children aged 3-10 years and children aged 8-14 years
- Includes leg guides, four-point pelvic positioning harness and adjustable sacral support
- Available with unique Leckey pelvic cradle for improved postural control
- Seat width and depth are continuously adjustable allowing for a large degree of growth
- Range of additional postural supports available
- Seating system fits a number of transporting systems

Code	Description	Seat Width	Seat Depth	Backrest Height	Max. User Weight
PED479339	Mygo Seating System	200 - 330 mm	270 - 430 mm	360 - 490 mm	50 kg



Early Activity System

- Designed to help with physical, cognitive and sensory development for babies with special needs
- Can be used by therapists as well as parents
- System comes as a "kit" to support the young child in lying on their tummy, lying on their back, side lying and sitting

Code	Description	Hip Width	Seat Depth	Backrest Height	Max. User Weight
PED480100	Early Activity System	150 - 200 mm	190 - 260 mm	100 mm	17 kg

REFER TO WHEELCHAIRS & SEATING SECTION FOR OUR FULL RANGE OF PAEDIATRIC WHEELCHAIRS





Advance Bath Chair

- Supports and holds the child to assist with bathing
- Easy-to-use adjustable legs can be set up prior to use
- Simple lever can be used to adjust the backrest recline position in the bath
- Washable, mesh fabric is breathable and soft to touch
- Folds flat for easy storage and transportation
- Accessories include head support, leg supports and shower trolley

Code	Description	Seat Width	Seat Depth	Back Height	Max. User Weight
PED478480	Advance Bath Chair Size 1, 1-5 years	425 mm	225 mm	350 mm	72 kg
PED478500	Advance Bath Chair Size 2, 4-9 years	425 mm	275 mm	400 mm	72 kg
PED478510	Advance Bath Chair Size 3, 8-14 years	425 mm	335 mm	460 mm	72 kg
PED478530	Advance Bath Chair Size 4, 12-18 years	425 mm	400 mm	550 mm	72 kg



Potty Chair Child

- The freestanding potty chair assists the user with limited mobility to comfortably toilet or shower
- Contoured fibreglass moulded shell seat, supplied standard with pelvic harness
- Powder coated mild steel frame that is zinc treated for corrosion resistance
- Fitted with non-slip rubber tips
- Accessories available including footrest, harness and chest strap
- Zinc treated for corrosion resistance

Code	Description	Seat Width	Seat Height	Warranty	Product Weight	Max. User Weight
PED478380	Potty Chair Child	310 mm	310 mm	12 months	7 kg	100 kg
PED478390	Potty Chair Child Mobile	310 mm	475 - 645 mm	12 months	10 kg	80 kg
PED478400	Potty Chair Tilt In Space Child	310 mm	670 mm	12 months	16 kg	80 kg
PED478410	Potty Chair Child Footrest			12 months		



Lars Car Seat

- Provides secure motor vehicle transportation of children with special needs
- Multiple options for correct positioning of a child in a vehicle
- Adjustable seat depth and back height
- Can be tilted from upright position to 25 degrees rear tilt
- Swivel action allows easy transfer
- Seat can be used on a stroller base or indoor high low unit

Code	Description
PED478470	Lars Car Seat

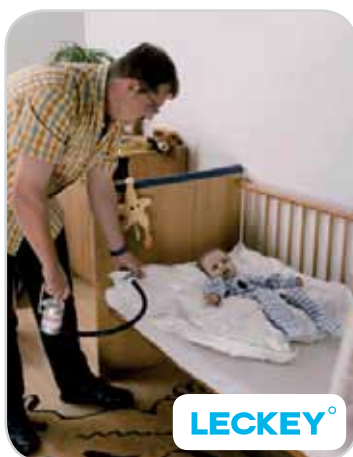

Sleepform

- Sleepform is a vacuum mattress moulded to support the user as part of a 24 hour positioning program
- Sleepform System is designed for children, adolescents and adults with special needs
- Promotes symmetry, reduces pain, slows the development of deformities
- Designed for use at home or in hospital and respite care centres

Code	Description
PED477010	Sleepform Kit Size 1
PED477020	Sleepform Kit Size 2
PED477030	Sleepform Kit Size 3
PED477040	Sleepform Kit Size 4



Paediatric Cot

- Paediatric Cot features a stainless steel or epoxy coated frame
- Mechanisms to operate drop sides located outside of the cot at mattress base for added safety
- Standard foam 50 mm mattress
- Four castors - two lockable for stability
- Can be tilted at Trendelenburg angle, up to 12 degrees above the horizontal
- Meets AS 2130
- Warranty: 36 months

Code	Description	Length	Width	Supplier Code	Code	Description	Length	Width	Supplier Code
WAT829900	Paediatric Cot SS	1440 mm	760 mm	KH942	WAT831200	Paediatric Cot Tray			KH942T
WAT830200	Paediatric Cot Arctic Fox	1440 mm	760 mm	KH942EA	WAT830600	Paediatric Cot IV Pole			KH942I
WAT830500	Paediatric Cot White	1440 mm	760 mm	KH942EW	WAT830800	Paediatric Cot Orthopaedic Frame			KH942O
WAT830300	Paediatric Cot Beige	1440 mm	760 mm	KH942EB	WAT830900	Paediatric Cot Oxygen Carrier			KH942OX
WAT830400	Paediatric Cot Blue/Wrave	1440 mm	760 mm	KH942EBW	WAT831000	Paediatric Cot Safety Enclosure			KH942SE
WAT830100	Paediatric Cot Double Latch			KH942DL	WAT831100	Paediatric Cot Safety Enclosure Coated			KH942SEE
WAT830700	Paediatric Cot Mattress Economy			KH942M					



Paediatric Cot Deluxe

- Paediatric Cot Deluxe features a stainless steel or epoxy coated frame
- Mechanisms to operate drop sides and ends located outside of the cot at mattress base for added safety
- Standard foam 50 mm mattress
- Four castors - two lockable
- Can be tilted at Trendelenburg angle, up to 12 degrees above the horizontal
- Meets AS 2130
- Warranty: 12 months

Code	Description	Length	Width	Supplier Code	Code	Description	Length	Width	Supplier Code
WAT831300	Paediatric Cot Deluxe SS	1440 mm	760 mm	KH943	WAT831800	Paediatric Cot Deluxe White	1440 mm	760 mm	KH943EW
WAT831500	Paediatric Cot Deluxe Arctic Fox	1440 mm	760 mm	KH943EA	WAT831900	Paediatric Cot Mattress Deluxe			KH943M
WAT831600	Paediatric Cot Deluxe Beige	1440 mm	760 mm	KH943EB	WAT830000	Paediatric Cot Chart Holder			KH942CH
WAT831700	Paediatric Cot Deluxe Blue/Weave	1440 mm	760 mm	KH943EBW					



Baby Bassinet Mobile

- Moulded acrylic bassinet
- 2 x moulded plastic utility trays
- Soft vinylclave covered mattress

Code	Description	Length	Width	Height	Supplier Code	Code	Description	Length	Width	Height	Supplier Code
WAT829000	Baby Bassinet Mobile Single Acrylic	780 mm	400 mm	990 mm	KH940	WAT829700	Baby Bassinet Mobile Twin Acrylic	805 mm	655 mm	990 mm	KH940T
WAT829600	Baby Bassinet Mobile Single S/Steel	780 mm	400 mm	990 mm	KH940S	WAT829800	Baby Bassinet Kerry Mobile Twin S/S	805 mm	655 mm	990 mm	KH940TS

Aidacare Online

For all of your product enquiries in one user-friendly site visit us online at www.aidacare.com.au

- New product releases - updated daily
- Clear and concise product descriptions and specifications
- Contract specific ordering information (DVA, TAC & MASS)
- Downloadable DVA RAP and other order forms
- Full colour product images
- Information on our range of service offerings
- Newsletter subscription page

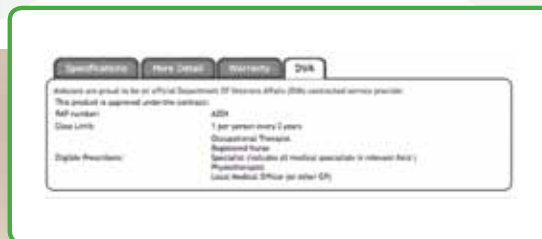

"We care for your care"



Pressure Care & Circulation



P 171 Protection - General

P 176 Protection - Hip

P 179 Protection - Skin & Limb

P 182 Protection - Waterproof

P 184 Compression - Legwear

P 184 - Medical Stocking Overview

P 186 - Ibici

P 189 - Jobst

P 193 - Med

P 198 - Ready Wrap garments

P 185 - GloriaMed

P 188 - Truform

P 191 - Venosan

P 196 - TED anti-embolism stockings

P 200 Compression - Arm & Hand

P 200 - Overview

P 201 - Jobst

P 203 - Medi

P 201 - GloriaMed

P 202 - Venosan

P 205 - Gloves (Norco/Isotoner/Handeze)

P 206 Compression - Lymphoedema

Compression - Donning & Doffing Aids

(refer to page 117)

Alternating Air Mattresses

(refer to page 078)

Pressure Relief Chairs

(refer to page 102)

Pressure Relief Cushions

(refer to page 346)



Sheepskin Overlay

- Genuine Australian lambswool overlay provides additional comfort to an existing mattress
- Soft pile allows air circulation to keep skin dry

DVA For eligibility & prescriber info please refer to pg 7.

Code	Description	Length	Width	RAP #:
PTA502500	Sheepskin Overlay	1130 mm	780 mm	AB11



Sheepskin Mattress Overlay

- A full covered medical sheepskin bed overlay, designed to cover head to toe
- Suitable for long term patients where shear and friction are a concern

DVA For eligibility & prescriber info please refer to pg 7.

Code	Description	Length	Width	RAP #:
PTA521400	Sheepskin Mattress Overlay	1250 mm	750 mm	AB11



Medical Sheepskin Overlay

- Medical grade sheepskin is a versatile product that can be used in the bed, on a chair or on a car seat
- Assists in pressure reduction, will absorb water, transfer heat away from the body and reduce shear and friction

DVA For eligibility & prescriber info please refer to pg 7.

Code	Description	Length	Width	RAP #:
PTA521500	Medical Sheepskin Overlay	1000 mm	650 mm	AB11



Wheelchair Footplate Cover

- High quality medical grade sheepskin covers provide natural comfort for any wheelchair
- Provide excellent skin protection and comfort

DVA For eligibility & prescriber info please refer to pg 7.

Code	Description	RAP #:
PTA522100	Wheelchair Footplate Cover	AB11
PTA522101	Wheelchair Calf Protector	AB11



Gel and Foam Underarm Crutch Covers

- Fit easily over the existing foam of the underarm/axilla crutches providing a comfortable support surface for the user



Cushion It

- The Cushion It Sheepskin Cover can be used directly on a seat or back canvas of a wheelchair
- Can be placed over standard foam cushions to increase pressure care and absorb perspiration

DVA For eligibility & prescriber info please refer to pg 7.

Code	Description
PTA509020	Gel and Foam Underarm Crutch Covers
PTA509021	Gel Underarm Crutch Handle Covers

Code	Description	Length	Width	RAP #:
PTA521300	Sheepskin Hi Temp - Cushion Seat Back	500 mm	500 mm	AB11



Gel Armrest Pads

- Ultimate gel comfort and protection for the elbows and wrists
- Distributes pressure efficiently to help avoid harmful pressure-related problems
- Durable neoprene nylon surface for easy cleaning

DVA For eligibility & prescriber info please refer to pg 7.

Code	Description	Length	Width	RAP #:
PTA508400	Gel Armrest Pads (Pair)	88.9 mm	304.8 mm	AP14
PTA508425	Gel Armrest Pads (Pair)	88.9 mm	355.6 mm	AP14
PTA508450	Gel Armrest Pads (Pair)	88.9 mm	406.4 mm	AP14



Gel Armrest Trough Liner

- Fits onto the Otto Bock trough channel forearm pad armrest
- Provides a comfortable, supportive gel support pad for the user

Code	Description	Length
PTA508470	Gel Armrest Trough Liner Medium	330.2 mm
PTA508480	Gel Armrest Trough Liner Large	482.6 mm



Gel Calf Support Panel

- Provide comfortable support to the lower legs in the seating position
- Single piece model features large gel pad, with 6 velcro secure straps
- Split Panel model allows use of swing away legrests without removal of the calf panel

DVA For eligibility & prescriber info please refer to pg 7.

Code	Description	Fits Wheelchair	RAP #:
PTA508500	Gel Calf Support Panel	40.64 to 50.80cm	AP14
PTA508550	Gel Calf Support Panel - 2 Sec.	40.64 to 50.80cm	AP14



Pressure Care Assist

- Can be used anywhere in the bed to assist with pressure care
- Made from medical grade sheepskin
- Helps reduce the risk of pressure area breakouts in the heels, sacrum, shoulders or head

DVA For eligibility & prescriber info please refer to pg 7.

Code	Description	RAP #:
PTA521600	Pressure Care Assist	AB11



Gel Footplate Protector Covers

- Designed to fit over existing footplates on a wheelchair
- Highly efficient at distributing pressure thereby avoiding harmful pressure-related problems

DVA For eligibility & prescriber info please refer to pg 7.

Code	Description	Size	RAP #:
PTA508600	Gel Covers (Pair)	203.2 x 152.4 mm	AP14
PTA508610	Gel & Foam Covers w/ Adhesive Back (Pair)	203.2 x 152.4 mm	AP14
PTA508615	Gel Single Piece Cover	279.4 x 228.6 mm	AP14



Gel Knee Protector Buttons

- Provide a soft surface to protect the users knees from bumping against legrests
- Attach to the inside of the legrests on a wheelchair
- Includes mounting hardware

DVA For eligibility & prescriber info please refer to pg 7.

Code	Description	RAP #:
PTA508800	Gel Knee Protector Buttons - Swing Away Legrests	AP14
PTA508830	Gel Knee Protector Buttons - Elevating Legrest	AP14
PTA508810	Gel Knee Protector Buttons - Swing Away Legrest	AP14
PTA508820	Gel Knee Protector Buttons - Elevating Legrests	AP14



Heelift Suspension Boot

- Designed by orthopedic surgeons specifically for prevention and treatment of heel pressure ulcers
- Effectively eliminates heel pressure by suspending the heel in the air

DVA For eligibility & prescriber info please refer to pg 7.

Code	Description	RAP #:
PTA509100	Heelift Suspension Boot Convuluted	AB11
PTA509200	Heelift Suspension Boot Smooth	AB11



Short Slipper Boot

- Assist in the prevention of pressure ulcers on the feet with an existing injury or condition
- Designed for use primarily in bed, wheelchair use or recliner chair use

DVA For eligibility & prescriber info please refer to pg 7.

Code	Description	Shoe Size US	RAP #:
PTA521897	Short Slipper Boot XX Small	3 - 4	AB11
PTA521898	Short Slipper Boot Extra Small	5 - 6	AB11
PTA521899	Short Slipper Boot Small	7 - 8	AB11
PTA521900	Short Slipper Boot Medium	9 - 10	AB11
PTA521901	Short Slipper Boot Large	11 - 12	AB11
PTA521902	Short Slipper Boot Extra Large	13 - 14	AB11
PTA521903	Short Slipper Boot XX Large	14 - 15	AB11



Wrap Around Boot

- Wrap Around Sheepskin Boots designed for those at risk of foot ulcers and other types of tissue damage
- Constructed with low profile EVA sole, these boots can be worn outside

DVA For eligibility & prescriber info please refer to pg 7.

Code	Description	Shoe Size US	RAP #:
PTA521704	Wrap Around Boot XX Small	3 - 4	AB11
PTA521705	Wrap Around Boot Extra Small	5 - 6	AB11
PTA521706	Wrap Around Boot Small	7 - 8	AB11
PTA521707	Wrap Around Boot Medium	9 - 10	AB11
PTA521708	Wrap Around Boot Large	11 - 12	AB11
PTA521709	Wrap Around Boot Extra Large	13 - 14	AB11
PTA521710	Wrap Around Boot XX Large	14 - 15	AB11



Pressure Care Boot

- Sheepskin Boots designed for those at risk of foot ulcers and other types of tissue damage
- Constructed with low profile EVA sole, these boots can be worn outside

DVA For eligibility & prescriber info please refer to pg 7.

Code	Description	Shoe Size US	RAP #:
PTA521697	Pressure Care Boot XX Small	3 - 4	AB11
PTA521698	Pressure Care Boot Extra Small	5 - 6	AB11
PTA521699	Pressure Care Boot Small	7 - 8	AB11
PTA521700	Pressure Care Boot Medium	9 - 10	AB11
PTA521701	Pressure Care Boot Large	11 - 12	AB11
PTA521702	Pressure Care Boot Extra Large	13 - 14	AB11
PTA521703	Pressure Care Boot XX Large	14 - 15	AB11



Tall Slipper Boot - Open Toe

- This product has been designed to protect the entire lower limb
- The Tall Slipper Sheepskin Boot can be worn in bed, in a chair or wheelchair and allows the use of compression bandages or support hosiery

DVA For eligibility & prescriber info please refer to pg 7.

Code	Description	RAP #:
PTA520499	Tall Slipper Boot - Open Toe Small	AB11
PTA520500	Tall Slipper Boot - Open Toe Large	AB11



Sovereign Snug

- Beautifully crafted Sheepskin Snugs will accommodate mild foot oedema whilst offering support and comfort
- Made especially from carefully selected lambskin material

DVA For eligibility & prescriber info please refer to pg 7.

Code	Description	Shoe Size US	RAP #:
PTA521905	Sovereign Snug Small	7 - 8	AB11
PTA521906	Sovereign Snug Medium	9 - 10	AB11
PTA521907	Sovereign Snug Large	11 - 12	AB11



Temporary Rehab Footwear - Pulman Shoes

Overview

- The Pulman range of therapeutic footwear is designed for those who suffer from sensitive feet or ailments which restrict mobility.
- They are particularly useful for post-operative care, and in the treatment of oedema and foot ulcers and malformed feet.
- This footwear features non-slip soles, and is multi-adjustable with Velcro closures, giving ease of application and a perfect, comfortable fit.
- Pulman products are sanitised, and are completely machine washable in warm water.
- Available in US shoe sizes 5 to 13.

Code	Description	Shoe Size US	RAP #:
NC1	New Classic 1 Boot	5 - 13	AJ06
NC2	New Classic 2 Shoe	5 - 13	AJ06
CX1	Classic Extra 1 Boot	5 - 13	AJ06
CX2	Classic Extra 2 Shoe	5 - 13	AJ06
NL	New Laurel	5 - 13	AJ06
LX	Laurel Extra	5 - 13	AJ06
New Leiden	New Leiden (no image available)	5 - 13	AJ06

DVA CONTRACTED

AJ06 BUY

Prescribers... Pod/O/S/Phys/P/RN/LMO

For approval rules refer to pg 7.



**FOR COMPRESSION & PROTECTION
GARMENTS REFER TO PG 170**



Pressure Care & Circulation



Foot Support - Footbeds - Hi - Impact Sports

- Recommended for most active sporting pursuits
- Provides excellent stability for walking/running & helps reduce foot pain & back & body fatigue

DVA For eligibility & prescriber info please refer to pg 7.

Code	Description	RAP #:
FBS281180	Foot Support - Footbeds - Hi-Impact Sports - Medium	AR04



Foot Support - Footbeds - Max Stability Contoured

- Max-Stability contoured footbeds are designed to stabilise the foot during activity
- Unsupported arches can result in pain & inflammation of the arch

DVA For eligibility & prescriber info please refer to pg 7.

Code	Description	RAP #:
FBS281155	Footbeds - Max Stability Contoured Small	AR04
FBS281150	Footbeds - Max Stability Contoured Medium	AR04
FBS281160	Footbeds - Max Stability Contoured Large - XLarge	AR04



Sillicon - Innersoles

- Superior silicone Medical Gel provide exceptional overall support , protection, comfort & help reduce painful shock waves to the body & lighten the load on joints
- Ideal for sports use, gardening, factory staff, construction workers, office staff & for people who stand on hard surfaces

DVA For eligibility & prescriber info please refer to pg 7.

Code	Description	RAP #:
FBS281200	Foot Support - Innersoles - Medium	AR04



Heel Protection - Heel Spur - Silicone Pad

- Clinically designed to assist in reducing pain associated with Heel Spurs
- Gently cushion the heel, while dissipating shock and shear generated by heel strike

DVA For eligibility & prescriber info please refer to pg 7.

Code	Description	RAP #:
FBS281210	Heel Protection - Heel Spur - Silicone Pad - Medium	AR04



Heelift Traction Boot

- Applies skin traction to help stabilise femur fractures prior to surgery and for protection post surgery
- Traction boot converts to a Heelift SMOOTH Suspension Boot once traction is no longer required



Heel Protectors Silicore Fibre

- Provides comfort and assists in the prevention of pressure build up in the heel area
- Silicone hollow core fibres provide soft comfortable support, while still keeping the rest of the foot cool in warm weather

DVA For eligibility & prescriber info please refer to pg 7.

Code	Description	Length	Width	Height	RAP #:
PTA509300	Heelift Traction Boot				
PTA503350	Heel Protectors Silicore Fibre	140 mm	100 mm	30 mm	AB11



Bed Heel Elevator

- Wedge-shaped contoured foam provides excellent support for the lower leg
- Rigid foam aids blood flow and reduces pressure

DVA For eligibility & prescriber info please refer to pg 7.

Code	Description	RAP #:
PTA509050	Bed Heel Elevator	AB17



ROHO Heelpad

- ROHO Heelpad offers an adjustable therapeutic environment which aids in the healing of heel and elbow ischemic ulcers
- Made from soft, latex free neoprene the heelpad is extremely durable

DVA For eligibility & prescriber info please refer to pg 7.

Code	Description	RAP #:
PTC541600	ROHO Heelpad	AB17



Heel Supports

- Protect the heel from ulcerations caused by bumps and knocks
- Made from medical grade sheepskin
- Wraps around the heel and ankle leaving the rest of the foot unencumbered

DVA For eligibility & prescriber info please refer to pg 7.

Code	Description	Show Size US	RAP #:
PTA521199	Heel Supports Small (Pair)	7 - 8	AB11
PTA521200	Heel Supports Medium (Pair)	9 - 10	AB11
PTA521201	Heel Supports Large (Pair)	11 - 12	AB11



Heel Protectors Spenco

- Made from medically treated, washable natural sheepskin
- The products have hook and loop tape closures and are available in a small, medium and large size

DVA For eligibility & prescriber info please refer to pg 7.

Code	Description	Length	Width	Height	RAP #:
PTA530200	Heel Protectors Spenco	140 mm	100 mm	30 mm	AB11



Gel Heel/Elbow Protector

- Gel Elbow/Heel Protectors are made from a comfortable, stretchable acrylic/spandex
- Designed to prevent trauma or wearing of the heel or elbow
- Sold as a pair

DVA For eligibility & prescriber info please refer to pg 7.

Code	Description	Size	RAP #:
PTA506400	Gel Heel/Elbow Protector Small	230 mm	AR29
PTA506500	Gel Heel/Elbow Protector Medium	280 mm	AR29
PTA506600	Gel Heel/Elbow Protector Large	330 mm	AR29



Elbow Lift Suspension Pad

- Cushions and elevates the elbow to minimise surface contact
- Helps protect the olecranon and olecranon bursa from friction burns and contusions
- Latex free

DVA For eligibility & prescriber info please refer to pg 7.

Code	Description
PTA508200	Elbow Lift Suspension Pad



Elbow Protector

- Provides elbow pressure point control
- Assists in avoiding skin tears, bruising and other tissue damage
- Easy and convenient velcro fastening
- Sold as a pair

DVA For eligibility & prescriber info please refer to pg 7.

Code	Description	RAP #:
PTA521099	Elbow Protector Small	AB11
PTA521100	Elbow Protector Medium	AB11
PTA521101	Elbow Protector Large	AB11



Palm Protector

- Provides comfort for patients with hand contractures
- Designed to offer moisture absorption, reducing the likelihood of maceration
- One size fits all

DVA For eligibility & prescriber info please refer to pg 7.

Code	Description	RAP #:
PTA521102	Palm Protector Left	AB11
PTA521103	Palm Protector Right	AB11



Support Gloves HANDEZE

- The HANDEZE® Support Gloves have been specially designed through ergonomic research and are user proven to help alleviate pain and swelling related to Arthritis, Tendonitis, Carpel Tunnel, Stress Related Injuries, Continuous Motion Syndrome, Hand Fatigue, Poor Circulation and Post Operative Procedures

DVA For eligibility & prescriber info please refer to pg 7.

Code	Description	RAP #:
PTA499910	Support Gloves HANDEZE - Small Beige	AR03
PTA499920	Support Gloves HANDEZE - Medium Beige	AR03
PTA499930	Support Gloves HANDEZE - Large Beige	AR03



Hipsaver

Overview

- Four distinct styles-accommodate the specific needs of the wearer

Further Options

- Permanently Sewn-In Pads (referred to as 'high compliance')
- Pants with pockets for removable pads

To Order

All garments have the same sizing. Please select the product code, followed by the size (eg. HS NH HC M/XL). For track pants specify whether regular or long (eg. HS TP/L).



SIZING CHART		Size	Hips (cm)	Size	Hips (cm)
<ul style="list-style-type: none"> • Sizing of all HipSaver products is from this chart • Measure around widest part of hip (over incontinence products if applicable) • Please tell us the size when ordering 		XS	70 - 79	L	100 - 112
		S	80 - 89	XL	113 - 127
		M	90 - 99	XXL	128 - 146

HIPSAVER Hip Protectors - Sewn-In Pads

DVA: RAP# AR28 For more information please refer to pg 7.

		NURSING HOME (sewn-in pads)		
		Designed for the mobility and comfort of residents plus convenience and peace of mind for carers.		
		<ul style="list-style-type: none"> • Full, soft fabric crotch perfectly accommodates incontinence pads or diapers • Elastic waistband and large leg openings for easy dressing and toileting • Wearable 24 hours a day - comfortable to sleep in • A popular all-round choice for most wearers 		
		To Order: Select code & size		
		Code Male	Code Female	
Male	Female	NURSING HOME - Regular	HS NH HC M	HS NH HC F
		NURSING HOME - Regular - Veterans kit (6 garments)	HS NH VHCP M	HS NH VHCP F
		NURSING HOME - Regular with tailbone protection	HS NH HC TP M	HS NH HC TP F



DVA: RAP# AR28 For more information please refer to pg 7.

		SLIM FIT (Sewn-In Pads)		
		Ideal for fashion conscious and active elders - those who are at risk of hip fracture, but reject uncomfortable and obvious hip protection products Looks good, feels good and pulls on just like regular underwear.		
		<ul style="list-style-type: none"> • Soft, thin (13mm) pads, tapered for protection with style • Made from ultra-soft breathable polycotton with form fitting Spandex® • SlimFit can accommodate an incontinence pad • Fully machine washable and dryable, even at high temperatures 		
		To Order: Select code & size		
		Code Male	Code Female	
Male	Female	SLIM FIT - Regular	HS SF HC M	HS SF HC F
		SLIM FIT - Regular - Veterans kit (6 garments)	HS SF VHCP M	HS SF VHCP F
		SLIM FIT - Regular with tailbone protection	HS SF HC TP M	HS SF HC TP F



HIPSAVER (cont.)

DVA: RAP# AR28 For more information please refer to pg 7.

 <p>Male</p>	 <p>Female</p>	QUICK CHANGE (Sewn-In Pads)		
		<p>Provides the same features and benefits of the Nursing Home model, but with the convenience of a snap down crotch panel.</p> <ul style="list-style-type: none"> Incontinence pads and diapers can be changed easily and quickly either while the wearer is standing or lying down Fabric covered low profile snaps for ease and comfort Not suitable for wearers toileting themselves Laundry safe for washing and drying up to 95°C 		
		To Order: Select code & size		
			Code Male	Code Female
		QUICK CHANGE - Regular	HS QC HC M	HS QC HC F
		QUICK CHANGE - Regular - Veterans kit (6 garments)	HS QC VHCP M	HS QC VHCP F
		QUICK CHANGE - Regular with tailbone protection	HS QC HC TP M	HS QC HC TP F

DVA: RAP# AR28 For more information please refer to pg 7.

	OPEN BOTTOM - (Sewn-In Pads)		
	<p>Requested by nursing staff for residents needing a garment that permits easy self - toileting.</p> <ul style="list-style-type: none"> The open crotch design is perfect for patients with urge incontinence or challenges in getting clothing on or off This garment is worn against the skin underneath any incontinence products, and allows a resident's normal underwear to be worn over the top of the protector Reduces accidents due to the 'fumble factor' - ideal for Parkinson's sufferers Laundry safe for washing and drying up to 95°C 		
	To Order: Select code & size		
		Code Unisex	
		OPEN BOTTOM - Regular	HS OB HC
		OPEN BOTTOM - Regular - Veterans kit (6 garments)	HS OB VHCP

HIPSAVER Hip Protectors (pants & pads separate)

DVA: RAP# AR28 For more information please refer to pg 7.

		Nursing home		Slim fit		Quick change		Open bottom
Pads Only - pr	Same for all pants Code: HS PADS	Code Male	Code Female	Code Male	Code Female	Code Male	Code Female	Code Unisex
Pants only	1 pants	HS NH PO M	HS NH PO F	HS SF PO M	HS SF PO F	HS QC PO M	HS QC PO F	HS OB PO
Starter kit	3 pants + 1 pr pads	HS NH SK M	HS NH SK F	HS SF SK M	HS SF SK F	HS QC SK M	HS QC SK F	HS OB SK
Veterans kit	6 pants + 2 pr pads	HS NH VK2 M	HS NH VK2 F	HS SF VK2 M	HS SF VK2 F	HS QC VK2 M	HS QC VK2 F	HS OB VK2

HIPSAVER Interim Overpant (Sewn-In Pads) - Unisex

DVA: RAP# AR28 For more information please refer to pg 7.

	Immediate hip protection.		
	<ul style="list-style-type: none"> ¾ length unisex pants with sewn - in hip protection pad Immediate hip protection for new admissions, acute care and short stay patients Residents with temporary changes in risk factors As a 'stop gap' component of your Falls Safety Programme while you order regular HipSaver for ongoing hip protection Colour - grey 		
	To Order: Select code & size		
		Code Unisex	
		Regular	HS I
		Regular with tailbone protection	HS I TP

Pressure Care & Circulation



HIPSAVER (cont.)

HIPSAVER Track Pants (Sewn-In Pads) - Unisex

✓ DVA: RAP# AR28 For more information please refer to pg 7.





Stylish hip protection for active seniors (Unisex)

- HipSaver Track Pants have the same all-soft hip protectors as other HipSaver garments
- Smartly designed in classic navy blue & pre-shrunk to fit properly (washable with regular laundry)
- The loose ankle hem prevents legs from binding and provides added comfort
- 2 lengths - regular (height under 170cm), long (over 170cm)

Options

- Hip Protection with Tailbone Padding (protects against backward falls)
- Hip Protection with Knee Pads (proper positioning and protects against forward falls)

To Order: Select code & size & Regular (R) or Long (L).

		Code Unisex
Regular		HS TP
	Pants (Regular (R) or Long (L).)	HS TP T
	Pants with tailbone protection (Regular (R) or Long (L).)	HS TP K
	Pants with tailbone padding and knee pads (Regular (R) or Long (L).)	HS TP TK

HIPSAVER Shorts - (Sewn-In Pads) - Unisex

✓ DVA: RAP# AR28 For more information please refer to pg 7.



Immediate hip protection.

- HipSaver Shorts have the same all-soft hip protectors as other HipSaver garments
- Smartly designed in classic navy blue
- Pre-shrunk to fit properly, and washable with regular laundry
- Five hip sizes offer a perfect fit for any active body
- Also available with tailbone protection which offers additional security for those who tend to fall backwards

To Order: Select code & size

		Code Unisex
	Shorts	HS SH
	Shorts with tailbone protection	HS SH T

Hornsby Comfy Hips

- Available with either Sewn-In Shields, or as pants with removable shields
- Available in either unisex styles, or male style (with fly opening)
- Comfortable fabric - 97% cotton
- Range of 7 sizes (see sizing chart) w/ Durable woven elastic waist band



To Order

Order by product code and size. (eg. HCH/USIC/XXL)

✓ DVA: RAP# AR28 For more information please refer to pg 7.



		Code Unisex	Code Male
Comfy hips hip protectors (Sewn-In Shields)		HCH/USIC	HCH/MSIC
Comfy hips protectors (pants & shields)		HCH /UPC	HCH/ MPC
Comfy hips protector shields (pair)		HCH/Shield	
Size	cm		
XXS	50 - 60		
XS	60 - 70		
S	70 - 80		
M	80 - 90		
L	90 - 100		
XL	100 - 110		
XXL	110 - 120		

Sizing: Measure around waist when standing (cm)



DERMASAVER - Limb & Skin Protectors



Overview



- Protects from pressure, friction and minor traumas
- Ample air flow reaching the skin
- 2 layers of soft, lightweight micro-spring textile (Latex free)
- Moisture transfer enhanced
- Anti-microbial - will not support growth of bacteria
- Totally washable

To Order

Order by product code and size. (eg. DS KP/Small)

Sizing



✓ DVA: RAP# AR29 For more information please refer to pg 7.

			HAND		
			Code	Size Guide	
			Knuckle protector	DS KP	Small: female/male Med/Large: male
			Dermamitt	DS DM	Small: female/male Med/Large: male
			Palm pillow	DS PP	One size fits all
			Finger separator	DS FS	One size fits all



Sizing - Forearm, Elbow & Arm Garments

Size	XS	S	M	L	XL
(cm)	13 - 18	18 - 25	25 - 30	30 - 38	38 - 46

✓ DVA: RAP# AR29 For more information please refer to pg 7.

		FOREARM & ELBOW	
			Code
		Elbow tube	DS ET
		Double elbow tube	DS DET
		Forearm tube	DS FT
		Forearm tube with knuckle protector	DS FTKP

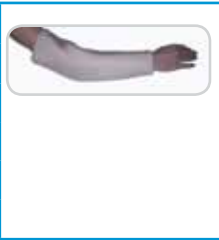
✓ DVA: RAP# AR29 For more information please refer to pg 7.

		ARMS	
			Code
		Arm tube	DS AT
		Arm tube with double elbow	DS AT DE
		Arm tube with knuckle protector	DS ATKP
		Zip tube for arms	DS ZT

Measurement: around widest part of forearm.



DERMASAVER (cont.)

Sizing - Ankle, Heel & Foot Garments					
Size	XS	S	M	L	XL
Ankle (cm)		under 23	23 - 28	28 - 33	over 33
Foot/Heel (cm)	under 28	28 - 30	30 - 35	35 - 38	over 39

ANKLE, HEEL & FOOT	Code
Stay-put heel protector	DS HP
Ankle bumper	DS AB
Total foot protector	DS DB

Measurement: DS AB - around widest part of ankle bone; DS HP/DS DB - around foot and heel.

✓ DVA: RAP# AR29 For more information please refer to pg 7.



Stay-put Heel Protector

Ankle Bumper

HEEL ELEVATOR		
<ul style="list-style-type: none"> Elevates the heel, and covers and protects both malleoli, the bony prominences on either side of the ankle Anatomically contoured and are more comfortable than other types of heel elevators Soft and stretchy, with a comfort ensuring 'give' DermaSaver Relevator Heel Elevators are made in 2 sizes 		
	Code	Size Guide
Heel elevator	DS HE	Small: foot/heel circumference below 35cm Large: foot/heel circumference above 35cm

✓ DVA: RAP# AR29 For more information please refer to pg 7.



Sizing - Leg Garments

Size	XS	S	M	L	XL
Leg (cm)	18 - 23	23 - 30	30 - 38	38 - 48	48 - 58
Amputee (cm)	20 - 25	25 - 30	30 - 38	38 - 45	45 - 56

LEG	Code
Leg tube	DS LT
Leg tube with double knee	DSLTKD
Amputee stump cover	DS ASC

✓ DVA: RAP# AR29 For more information please refer to pg 7.

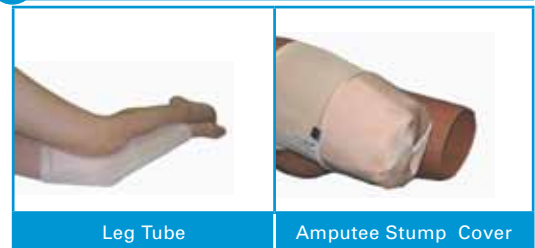

Leg Tube

Amputee Stump Cover

Measurement: DS ASC - around leg 5cm above amputation; DS LT/ DS LTKD - around calf.

PROTECT-A-LIMB - Limb & Skin Protectors

✓ DVA: RAP# AR29 For more information please refer to pg 7.

LIMB & SKIN PROTECTORS		
		
<p>Overview & Features:</p> <p>Protect-A-Limb® protects the limbs from skin tears and skin damage.</p> <ul style="list-style-type: none"> Protection against friction and impact Durable and comfortable to wear Constructed of Coolmax® fabric on the inner surface, and slightly retentive cotton on the outer surface Moisture wicking and prevents maceration Sealed ends prevent fraying Supplied as pairs 		
<p>To Order: Select code</p>		
Code	Size	Size Guide
PL 1	S	Suits arm and small leg
PL 2	M	Suits arm and average lower leg
PL 3	L	Full leg length



Gel Bodies

Overview

- Gel provides pressure-relieving skin protection, and enhanced protection from skin breakage and the development of pressure sores
- Lightweight and comfortable
- Improves circulation
- Uses a pressure-relieving gel found in high-end wheelchair cushions
- Cotton-lycra "coolband" stretches for ideal fit and feels great against the skin
- Machine washable
- Supplied as pairs



To Order

Order by product code and size. (eg. GB HEP / S)

Sizing

For borderline measurements, choose the larger size for extra comfort.

GelBodies - Pressure-relieving skin protection

✓ DVA: RAP# AR29 For more information please refer to pg 7.

	HEEL & ELBOW		
	Code:	Size	Arm or Calf (cm)
	GB HEP	S	20 - 25
	GB HEP	M	25 - 30
	GB HEP	L	30 - 36
	GB HEP	XL	36 - 41

Measure around calf or upper arm.

✓ DVA: RAP# AR29 For more information please refer to pg 7.

	KNEE		
	Code:	Size	Knee (cm)
	GB KP	S	23 - 28
	GB KP	M	28 - 33
	GB KP	L	33 - 41

Measure around knee.

✓ DVA: RAP# AR29 For more information please refer to pg 7.

	CALF		
	Code:	Size	Calf (cm)
	GB SP	M	25 - 33
	GB SP	L	30 - 41

Measure around calf.

✓ DVA: RAP# AR29 For more information please refer to pg 7.

	ANKLE		
	Code:	Size	Ankle (cm)
	GB HAP	S	20 - 25
	GB HAP	M	25 - 30
	GB HAP	L	30 - 36

Pressure Care & Circulation



Rolyan



To Order

Order by product code and size. (eg. A731/S) - Sold in pairs.

Sizing

For borderline measurements, choose the larger size for extra comfort.

Heel/Elbow Protector - Foam

DVA: RAP# AR29 [For more information please refer to pg 7.](#)

	PROTECTOR - FOAM		
	Foam padding helps maintain skin integrity and prevent ulcerations or injury to elbow or heel.		
	<ul style="list-style-type: none"> Cushioned heel and elbow protector with foam pad can be machine washed and dried Medication can be applied to pad when needed Sold in pairs 		
	Code	Size	Size Guide
	A731	S	Fits most small and medium women
A731	M/L	Fits larger women and average-sized men	
A731	XL	Fits larger men	

Heel/Elbow Protector - Gel

DVA: RAP# AR29 [For more information please refer to pg 7.](#)

	PROTECTOR - GEL		
	Shock-absorbing gel padding is effective following sudden injury or cumulative trauma injury to the elbow or heel.		
	<ul style="list-style-type: none"> Helps protect the joint by diffusing and distributing pressure Includes 6.4mm shock-absorbing gel pad, which won't bottom out Sold in pairs 		
	Code	Size	Size Guide
	A730001	S	Fits most small and medium women
A730002	M/L	Fits larger women and average-sized men	
A730003	XL	Fits larger men	

Limbo

Overview

Waterproof limb protection for casts, wound and leg ulcer dressings and compression garments.

- Limbo waterproof protectors are comfortable, easy-to-use, and reusable. They can be completely submerged for bathing, swimming or in hydro pools.
- The Limbo is a self-sealing, self supporting garment which prevents the penetration of water to plaster casts, compression garments and wound dressings on limbs during bathing
- It is a non-sterile product and is primarily intended for use in a bath or shower



To Order

Order by product code

Hand/Wrist - LO AH MITT

DVA: RAP# AR29 [For more information please refer to pg 7.](#)

	FEATURES	
	<ul style="list-style-type: none"> Standard size fits most adults with forearm circumference of 22 - 25cm when measured 5cm below the elbow Seals 10cms above the hand Not suitable for use with thumb injuries Please use the Adult Elbow Protector for thumb injuries 	
	Code	Arm Circ (cm)
LO AH MITT	22 - 25	



LimbO (cont.)



Adult Below Elbow - LO ABE

✓ DVA: RAP# AZ06 For more information please refer to pg 7.

Code	Size	Arm Circ (cm)
LO ABE M50A	XS	22 - 25
LO ABE M60	S	25 - 29
LO ABE M67	L	30 - 40

Measure arm circumference 8cm above the elbow.



Adult Full Arm - LO AFA

✓ DVA: RAP# AZ06 For more information please refer to pg 7.

Code	Size	Arm Circ (cm)
LO AFA M60L	S	25 - 29
LO AFA M70	L	30 - 40

Measure circumference at top of arm above cast/bandage.



Adult Elbow - LO AE

✓ DVA: RAP# AZ06 For more information please refer to pg 7.

Code	Size	Arm Circ (cm)
LO AE M65	S	25 - 29
LO AE M75	L	30 - 40

Measure upper arm circumference.

Adult Below Knee - LO ABK

✓ DVA: RAP# AZ06 For more information please refer to pg 7.



SIZING			
<ul style="list-style-type: none"> Determine user height first, and then take leg circumference to determine garment size Leg circumference is taken 10cm above the knee 			
Code	Size (height/leg)	User Height (cm)	Leg Circ (cm)
LO ABK M76SS	XShort/xsmall	to 157	35 - 40
LO ABK M80SS	XShort/small	to 157	39 - 54
LO ABK M76S	Short/xsmall	157 - 164	35 - 40
LO ABK M80S	Short/small	157 - 164	39 - 54
LO ABK M180S	Short/large	157 - 164	52 - 59
LO ABK M76	Average/xsmall	165 - 183	35 - 40
LO ABK M80	Average/small	165 - 183	39 - 54
LO ABK M180	Average/large	165 - 183	52 - 59
LO ABK M80L	Tall/small	183 +	39 - 54
LO ABK M180L	Tall/large	183 +	52 - 59

Adult Full Leg - LO AFL

✓ DVA: RAP# AZ06 For more information please refer to pg 7.



SIZING			
<ul style="list-style-type: none"> Determine user height first, and then take leg circumference to determine garment size Leg circumference is taken 2cm above cast/dressing or area to which protection is needed 			
Code	Size (height/leg)	User Height (cm)	Leg Circ (cm)
LO AFL M80E	Short/small	153 - 163	39 - 54
LO AFL M100S	Short/large	153 - 163	52 - 65
LO AFL M80LL	Average/small	165 - 183	39 - 54
LO AFL M100	Average/large	165 - 183	52 - 65
LO AFL M100L	Tall/large	184 - 196	52 - 65



Medical Legwear/Stocking Overview

Purpose of Medical Stockings

- Improve blood flow in the lower limbs & assist in the prevention and management of venous disease
- Widely used to treat fluid build-up associated with lymphoedema

Compression Values

- Medical stockings feature “graduated compression” - strongest at the ankle & progressively reducing up the leg
- Compression is measured in mmHg (millimetres of mercury compression) at the ankle
- **Stockings < 20mmHg** - (Preventative) Suitable for general leg relief, mild varicose veins, safeguard against DVT
- **Stockings > 20mmHg** - (Therapeutic) More-serious or pre-existing conditions. For > 30 mmHg prescription required.

PREVENTATIVE	THERAPEUTIC		
15-20mmHg	20-30mmHg (class 1)	30-40mmHg (class 2)	40-50 mmHg (class 3)
Moderate <ul style="list-style-type: none"> • Tired, aching legs • Mild varicose veins • Mild varicose veins during pregnancy • Mild fluid retention • Post sclerotherapy • Travel - for those with otherwise healthy legs 	Firm <ul style="list-style-type: none"> • Mild/moderate varicose veins • Varicosities tending towards mild oedema • Varicose veins during and after pregnancy • Prevention of thrombosis (ambulatory) • Post sclerotherapy 	Extra Firm <ul style="list-style-type: none"> • Mild chronic venous insufficiency • Moderate/severe varicosities during pregnancy • Phlebitis with mild oedema • After deep vein thrombosis • Diffuse varicosities • Varicose ulcers • Mild lymphoedema 	Strong <ul style="list-style-type: none"> • Pronounced varicosities with oedema • Pronounced chronic venous insufficiency • After deep thrombophlebitis • Valvular insufficiency of the deep veins • Varicose ulcers & Lymphoedema
Contraindications	Arteriopathy, hyperdermatitis in acute state, wet dermatosis, cutaneous infections, unreduced oedema, acute thrombophlebitis.		

Styles Available

- **Closed-toe** (full-foot, like a sock) - Most common. Appropriate where swelling of the foot/toes
- **Open-toe** (toes exposed) - Suitable where large foot size relative to leg measurement



Fitting Guide/Selection Guide

- Correct Measurement and sizing **ARE THE** most important things
- Cotton is better for sensitive skin and stronger compression stockings (eg. 30-40mmHg) should have rubber stretch, not lycra
- **Knee High** - Ensure the top-band is flat against the leg, about 2 - 3cm below the knee crease. Do not allow the stocking to roll over at the top, and never double the stocking over at the top if it seems too long
- **Sizing Selection** - Select size according to the **largest measurement** taken (eg. if ankle is ‘small’, and calf is ‘medium’, select the medium)

✓ RAP #	DVA Approval Needed?	DVA Approval Rules	Eligible Prescriber*
AR22	No (unless Aidacare advises)	Limit of 3 pairs every 6 months	S, RN, Physio, OT, LMO
DVA Comments	*For lymphoedema garments, health providers should have specialist post graduate training in oedema/lymphoedema management in order to access, measure, fit and review these garments.		



GloriaMed - Medical Legwear

Overview

- Made in Italy, Gloria Med is one of the oldest and most respected manufacturers of compression legwear
- Conforms to all recognised international standards





To Order

Select size and then order by: Code/Side/Colour/Size (eg. G141AD/Left/Black/XL).

Size Selection Guide

- Measure the Ankle just above ankle bone; then 2cm Below-knee; then Thigh 5cm below groin
- If one size-category difference: Select the larger size
- If > one size-category difference: Contact Aidacare for assistance

GloriaMed - Unisex Stockings

		KEY FEATURES					
		<p>Fabric:</p> <ul style="list-style-type: none"> • Choice of soft, comfortable nylon • Hypoallergenic 100% cotton <p>Fractional Fit:</p> <ul style="list-style-type: none"> • 20 sizes in each style - perfect fit 					
		Size	Ankle (cm)	Below Knee (cm) Regular	Below Knee (cm) wide	Upper Thigh (cm) Regular	Upper Thigh (cm) wide
		XS	18 - 19	28 - 30	31 - 34	42 - 46	47 - 51
		S	20 - 22	31 - 34	35 - 38	47 - 51	52 - 57
		M	23 - 25	35 - 38	39 - 42	52 - 57	58 - 63
		L	26 - 28	39 - 42	43 - 47	58 - 63	64 - 70
		XL	29 - 31	43 - 47	48 - 52	64 - 70	71 - 78
		LENGTH					
		Knee high: Short (up to 38cm) - Long (> 39cm)			Thigh/waist high: Short (up to 71cm) - Long (> 72cm)		

 **DVA: RAP# AR22** For more information please refer to pg 7.

GLORIAMED - NYLON - UNISEX				
mmHg	Code	Description	Select Side	Select Colour
20-30mmHg	G141AD	Knee high - open toe		Beige
	G151AD	Knee high - closed toe		Beige, Black
	G141AG	Thigh high - plain top - open toe	Left/right	Beige
	G141AGGT	Thigh high - unisex grip top - open toe		Beige
	G141AGG	Thigh/belt - single leg/belt - open toe		Beige
30-40mmHg	G241AD	Knee high - open toe		Beige
	G251AD	Knee high - closed toe		Beige, Black
	G241AG	Thigh high - plain top - open toe	Left/right	Beige
	G241AGGT	Thigh high - unisex grip top - open toe		Beige
	G241AGG	Thigh/belt - single leg/belt - open toe		Beige
40-50mmHg	G361AD	Knee high - open toe		Beige
	G361AGG	Thigh/belt - single leg/belt - open toe	Left/right	Beige
	G361AT	Waist high - open toe		Beige
GLORIAMED - COTTON - UNISEX				
20-30mmHg	G162AD	Knee high - open toe	Left/right	Beige
	G162AGG	Thigh/belt - single leg/belt - open toe		Beige
30-40mmHg	G262AD	Knee high - open toe	Left/right	Beige
	G262AGG	Thigh/belt - single leg/belt - open toe		Beige



GloriMed Micro Mesh (pantyhose for women)

DVA: RAP# AR22 [For more information please refer to pg 7.](#)



KEY FEATURES

- Fashionable and sheer
- Suits all standard body shapes
- 4 Sizes
- Short or long fittings
- Closed-toe
- Beige or black

Size	Ankle (cm)	Below Knee (cm)	Upper Thigh (cm)
XS	20 - 21	31 - 34	52 - 57
S	22 - 23	33 - 36	55 - 60
M	24 - 25	35 - 38	58 - 63
L	26 - 27	37 - 40	61 - 66
XL	20 - 21	31 - 34	52 - 57

LENGTH

Short (up to 71cm) - Long (> 72cm)

GloriMed Micro Mesh (pantyhose for women)

Code	Description	Compression	Select Colour
G191AT	191 Waist high, 20-30 - pantyhose - closed toe	20-30mmHg	Beige, Black
G291AT	291 Waist high, 30-40 - pantyhose - closed toe	30-40mmHg	Beige, Black

IBICI - Medical Legwear



Overview

Designed and manufactured in Italy, IBICI's compression legwear range is ideal for mild vascular conditions, or as a preventative measure. All IBICI garments have a closed toe (full foot)

- Segreta 140 for Women
- Segreta Plus
- Repomen for Men
- Skywalk Unisex

To Order

Select product Code, followed by Size and Colour (eg. IB 140/Size 5/Black).

Segreta 140 for Women & Segreta Plus

DVA: RAP# AR22 [For more information please refer to pg 7.](#)

Sizing Chart 1: SEGRETA 140 & SEGRETA PLUS - KNEE HIGHS FOR WOMEN		Note: size 6 available in 140 knee highs only.					
	Correct sizing requires shoe size (metric european), ankle and calf measurements (cm).						
	<ul style="list-style-type: none"> • Ankle - the narrowest point of the ankle, immediately above the ankle bone • Calf - circumference around the widest part of the lower leg 						
Product	Size (cm)						
	1	2	3	4	5	6	
Shoe	34 - 35	35 - 36	37 - 38	39 - 40	41 - 42	42 - 43	
Ankle	17 - 20	19 - 22	20 - 24	21 - 26	22 - 28	23 - 29	
Calf	28 - 38	30 - 39	31 - 40	32 - 41	33 - 42	34 - 43	



REFER TO PG 117 FOR OUR DONNING & DOFFING AIDS



IBICI - Medical Legwear (cont.)

DVA: RAP# AR22 For more information please refer to pg 7.

Sizing Chart 2: SEGRETA 140 & SEGRETA PLUS - THIGH HIGH & PANTYHOSE



- First, determine size from the height/weight grid
- Then check that size against the ankle measurements in Chart 1. If one measurement indicates a larger size than the other, select the larger size
- If more than 1 size difference, contact Aidacare for assistance

Height	Weight (kg)																	
	40	44	48	52	56	60	64	68	72	76	80	84	88	92	96	100	104	108
150 cm		1									2 W (1)							
155 cm													3 W (1)					
160 cm			2															
165 cm					3												4 W (1)	
170 cm								4										
175 cm																		
180 cm										5								
185 cm																		
190 cm																		
195 cm																		

Notes:

- 1) 'W' sizes on grid (for fuller, shorter figure), available in 140 waist high (panty hose) only.
- 2) Size 6 available only in 140 waist high (panty hose), and only while current stocks last. These will be discontinued in due course.

SEGRETA 140 for Women - Super Sheer (15-20mmHg)

DVA: RAP# AR22 For more information please refer to pg 7.

- Fashionably sheer, in a range of colours and styles, including pantyhose designed for the shorter, fuller figure
- Maternity pantyhose are not on the DVA/RAP schedule

Code	Description	Sizes	Colour	Sizing Chart
IB140	Knee high	6 sizes (1 - 6)	Black, Tan, Beige, Cream, White	1
IB142	Thigh high - plain top	5 sizes (1 - 5)	Black, Beige	2
GLADY	Thigh high - grip top	5 sizes (1 - 5)	Black, Beige	2
IB144	Waist high - pantyhose - regular fitting	6 sizes (1 - 6)	Black, Tan, Beige, White	2
IB148	Waist high - pantyhose - shorter, fuller figure	3 sizes (2W - 4W)	Beige	2
IB146	Waist high - pantyhose - maternity (not on rap)	5 sizes (1 - 5)	Black, Beige	2

SEGRETA PLUS for Women (23-27mmHg)

DVA: RAP# AR22 For more information please refer to pg 7.

- Comparable to 20-30, these give additional compression at the ankle
- The plus are semi-sheer, and are in beige only

Code	Description	Sizes	Colour	Sizing Chart
IB240	Knee high	5 sizes (1 - 5)	Beige	1
IB242	Thigh high - plain top	5 sizes (1 - 5)	Beige	2
IB244	Waist high - pantyhose	5 sizes (1 - 5)	Beige	2

REPOMEN - Knee Highs for Men (15-20mmHg)

DVA: RAP# AR22 For more information please refer to pg 7.

- With the stylish appearance of dress socks
- 9 Colours to choose from

Code	Description	Sizes	Colour	Sizing Chart
IB141	Knee high	5 sizes (XS - XL)	Black, Beige, White	3

Sizing Chart 3: REPOMEN - KNEE HIGHS FOR MEN (15-20mmHg)



Correct sizing requires shoe size (metric European), ankle and calf measurements (cm).

- Ankle - the narrowest point of the ankle, immediately above the ankle bone
- Calf - circumference around the widest part of the lower leg

Product	Size (cm)				
	XS	S	M	L	XL
Shoe	37 - 38	39 - 40	41 - 42	43 - 44	45 - 46
Ankle	18 - 21	20 - 23	21 - 25	22 - 27	23 - 28
Calf	30 - 40	32 - 42	33 - 43	34 - 46	35 - 48

Pressure Care & Circulation



IBICI - Medical Legwear (cont.)

SKYWALK - Knee Highs - Unisex (15-20mmHg)

DVA: RAP# AR22 For more information please refer to pg 7.

- Designed as a travel sock, but also suitable for day-to-day wear in the prevention and relief of mild vascular conditions
- Similar to repomen in appearance and compression, but featuring a high cotton content (33%) for added softness and comfort

Code	Description	Sizes	Colour	Sizing Chart
IBSW	Knee high	5 sizes (XS - XL)	Black	4

Sizing Chart 4: SKYWALK - KNEE HIGHS



Correct sizing requires shoe size (metric European), ankle and calf measurements (cm).

- Ankle - the narrowest point of the ankle, immediately above the ankle bone
- Calf - circumference around the widest part of the lower leg

Product	Size (cm)				
	XS	S	M	L	XL
Ankle	18 - 21	20 - 23	22 - 25	24 - 27	26 - 29
Calf	27 - 37	30 - 40	33 - 43	36 - 46	39 - 49

Truform - Medical Legwear



Overview

- Manufactured in the USA, the Truform Classic range of knee high stockings is available in off-the-shelf sizes up to XXXLarge
- This super-large size fits an ankle up to 35cm., and a calf up to 61cm, measurements which would otherwise require expensive, made-to-measure stockings

Sizing Guide

Take the ankle and calf measurements to determine size.

- Ankle - narrowest point of ankle, just above the ankle bone.
- Calf - the widest part of the lower leg

Size	Ankle (cm)	Calf (cm)	Size	Ankle (cm)	Calf (cm)
S	17.5 - 21	28 - 36	XL	28 - 31.5	44 - 51
M	21 - 24.5	34 - 41	XXL	31.5 - 35	49 - 56
L	24.5 - 28	39 - 46	XXXL	31.5 - 35	55 - 61

To Order

Select product code, followed by size and colour (eg. TR865 - BG/XL)

TRUFORM Classic - Unisex

DVA: RAP# AR22 For more information please refer to pg 7.



	20-30mmHg	30-40mmHg
Knee high - open toe - beige	TR865 - BG	TR845 - BG
Knee high - closed toe - beige	TR8865 - BG	TR8845 - BG
Knee high - closed toe - black	TR8865 - BL	TR8845 - BL



REFER TO PG 117 FOR OUR
DONNING & DOFFING AIDS



Jobst - Medical Legwear



Overview

- **'UltraSheer' for Women:** sheer, comfortable and shaped for women
- **Jobst 'for Men':** comfortable, lightweight and stylish ribbed design. These are closed-toe stockings of nylon fabric, and are available in a selection of colours, styles, and compression ranges from 15-20 to 30-40mmHg. These stockings come in 4 sizes. Small to X-Large
- **Jobst 'Relief' (Unisex):** a more durable range in knee-high, thigh-high, pantyhose and chaps style (single leg with waist belt), with compression values of 20-30 and 30-40mmHg. Available with either closed or open-toe, and two extra large sizes in knee highs. Beige only
- **Jobst 'Ulcercare' (40mmHg):** Designed to help in the healing of venous leg ulcers, the Jobst Ulcercare two-stocking system provides the gradient compression required for a venous ulcer to heal.

Sizing Guide

KNEE HIGHS:

Sizing is the same for all jobst knee high stockings, but there are an additional 2 larger sizes in the relief knee highs.

Take the ankle and calf measurements to determine size:

- Ankle - the narrowest point of the ankle, immediately above the ankle bone
- Calf - the widest part of the lower leg

THIGH & WAIST HIGH:

In addition to ankle and calf measurements.

- Take the measurement around the top of the leg (groin)
- The waist high (pantyhose), also require a hip measurement

Product	Size (cm)					
	S	M	L	XL	L full calf 'Relief' Only	XL full calf 'Relief' Only
Ankle (cm)	18 - 21	21 - 25	25 - 29	29 - 33	25 - 30	30 - 36
Calf (cm)	30 - 42	30 - 42	32 - 46	34 - 50	46 - 61	46 - 61
Groin (cm)	40 - 62	46 - 70	60 - 81	60 - 81		
Hip (cm)	76 - 127	76 - 127	102 - 166	102 - 166		

To Order

Select product code only. (eg. J5165-04)

Jobst UltraSheer for Women

DVA: RAP# AR22 For more information please refer to pg 7.

CLOSED TOE ONLY										
Size	Colour	15-20mmHg			20-30mmHg			30-40mmHg		
		Knee high	Thigh high (Grip top)	Waist high (Pantyhose)	Knee high	Thigh high (Grip top)	Waist high (Pantyhose)	Knee high	Thigh high (Grip top)	Waist high (Pantyhose)
PRODUCT CODE										
S	Black	J75165 - 04	J75169 - 04	J75173 - 04	J75201 - 04	J75205 - 04	J75209 - 04	J75241 - 04	J75245 - 04	J75249 - 04
M	Black	J75166 - 04	J75170 - 04	J75174 - 04	J75202 - 04	J75206 - 04	J75210 - 04	J75242 - 04	J75246 - 04	J75250 - 04
L	Black	J75167 - 04	J75171 - 04	J75175 - 04	J75203 - 04	J75207 - 04	J75211 - 04	J75243 - 04	J75247 - 04	J75251 - 04
XL	Black	J75168 - 04	J75172 - 04	J75176 - 04	J75204 - 04	J75208 - 04	J75212 - 04	J75244 - 04	J75248 - 04	J75252 - 04
S	Natural	J75165 - 25	J75169 - 00	J75173 - 00	J75201 - 19	J75205 - 00	J75209 - 00	J75241 - 21	J75245 - 00	J75249 - 00
M	Natural	J75166 - 25	J75170 - 00	J75174 - 00	J75202 - 19	J75206 - 00	J75210 - 00	J75242 - 21	J75246 - 00	J75250 - 00
L	Natural	J75167 - 25	J75171 - 00	J75175 - 00	J75203 - 19	J75207 - 00	J75211 - 00	J75243 - 21	J75247 - 00	J75251 - 00
XL	Natural	J75168 - 25	J75172 - 00	J75176 - 00	J75204 - 19	J75208 - 00	J75212 - 00	J75244 - 21	J75248 - 00	J75252 - 00
S	Suntan	J75165 - 26	J75169 - 01	J75173 - 01	J75201 - 20	J75205 - 01	J75209 - 01	-	-	-
M	Suntan	J75166 - 26	J75170 - 01	J75174 - 01	J75202 - 20	J75206 - 01	J75210 - 01	-	-	-
L	Suntan	J75167 - 26	J75171 - 01	J75175 - 01	J75203 - 20	J75207 - 01	J75211 - 01	-	-	-
XL	Suntan	J75168 - 26	J75172 - 01	J75176 - 01	J75204 - 20	J75208 - 01	J75212 - 01	-	-	-

Pressure Care & Circulation



Jobst for Men

DVA: RAP# AR22 For more information please refer to pg 7.

		CLOSED TOE ONLY					
		Knee high	Thigh high (Grip top)	Knee high	Thigh high (Grip top)	Knee high	Thigh high (Grip top)
		15-20mmHg		20-30mmHg		30-40mmHg	
Size	Colour	PRODUCT CODE					
S	Black	J75253 - 01	-	J75257 - 01	J75261 - 00	J75265 - 01	J75269 - 00
M	Black	J75254 - 01	-	J75258 - 01	J75262 - 00	J75266 - 01	J75270 - 00
L	Black	J75255 - 01	-	J75259 - 01	J75263 - 00	J75267 - 01	J75271 - 00
XL	Black	J75256 - 01	-	J75260 - 01	J75264 - 00	J75268 - 01	J75272 - 00
S	Navy	J75253 - 00	-	J75257 - 00	-	J75265 - 00	-
M	Navy	J75254 - 00	-	J75258 - 00	-	J75266 - 00	-
L	Navy	J75255 - 00	-	J75259 - 00	-	J75267 - 00	-
XL	Navy	J75256 - 00	-	J75260 - 00	-	J75268 - 00	-
S	Brown	-	-	J75257 - 02	-	J75265 - 02	-
M	Brown	-	-	J75258 - 02	-	J75266 - 02	-
L	Brown	-	-	J75259 - 02	-	J75267 - 02	-
XL	Brown	-	-	J75260 - 02	-	J75268 - 02	-

Jobst Relief - Unisex

DVA: RAP# AR22 For more information please refer to pg 7.

		OPEN TOE - BEIGE ONLY									
		PRODUCT CODE									
		Knee high	Thigh high (Grip top)	CHAPS left	CHAPS right	Waist high (Pantyhose)	Knee high	Thigh high (Grip top)	CHAPS left	CHAPS right	Waist high (Pantyhose)
Size		20-30mmHg					30-40mmH				
S		J114625A	J78042 - 08	J114672-A	J114676 - A	J114660A	J114635A	J78059 - 08	J114784 - A	J114788 - A	J114668A
M		J114626A	J78043 - 08	J114673-A	J114677 - A	J114661A	J114636A	J78047 - 08	J114785 - A	J114789 - A	J114669A
L		J114627A	J78044 - 08	J114674-A	J114678 - A	J114662A	J114637A	J78048 - 08	J114786 - A	J114790 - A	J114670A
XL		J114628A	J78045 - 08	J114675-A	J114679 - A	J114663A	J114638A	J78049 - 08	J114787 - A	J114791 - A	J114671A
L full calf		J114696A	-	-	-	-	J114697A	-	-	-	-
XL full calf		J114629A	-	-	-	-	J114639A	-	-	-	-
		CLOSED TOE - BEIGE ONLY									
S		J114620A	J78042 - 09	-	-	J114656A	J114630A	J78059 - 09	-	-	-
M		J114621A	J78043 - 09	-	-	J114657A	J114631A	J78047 - 09	-	-	-
L		J114622A	J78044 - 09	-	-	J114658A	J114632A	J78048 - 09	-	-	-
XL		J114623A	J78045 - 09	-	-	J114659A	J114633A	J78049 - 09	-	-	-
L full calf		J114698A	-	-	-	-	J114699A	-	-	-	-
XL full calf		J114624A	-	-	-	-	J114634A	-	-	-	-

Pressure Care & Circulation



REFER TO PG 117 FOR OUR
DONNING & DOFFING AIDS



Jobst 'Ulcercare' (40mmHg)

- Jobst UlcerCare 2 in 1 compression system comprises a 25mmHg zippered stocking and a 17mmHg slip-on liner
- The two-stocking system supplies the gradient compression required for a venous ulcer to heal
- The light compression liner stocking holds dressing in place and helps the zippered stocking to slide on easily

Sizing

Jobst Ulcercare		Small	Medium	Large	XLarge	XXLarge
Starter kit (stocking and 2 liners)	Ankle	18 - 21 cm	21 - 24 cm	24 - 27 cm	27 - 30 cm	30 - 33 cm
Replacement liners (3 pack)	Calf	29 - 35 cm	34 - 41 cm	40 - 47 cm	46 - 54 cm	48 - 56 cm

To Order

Select product code. (NB: Ensure zipper is on opposite side to wound)

DVA: RAP# AR22 For more information please refer to pg 7.

Jobst Ulcercare	Small	Medium	Large	XLarge	XXLarge
Jobst 2 in 1 40mmhg ulcercare kit (stocking and 2 liners):					
Zipper on left side	J3631 - 61	J3631 - 62	J3631 - 63	J3631 - 64	J3631 - 65
Zipper on right side	J3631 - 21	J3631 - 22	J3631 - 23	J3631 - 24	J3631 - 25
Jobst 17mmhg ulcercare liners:					
Replacement liners (3 pack)	J3632 - 21	J3632 - 22	J3632 - 23	J3632 - 24	J3632 - 25

Venosan - Medical Legwear



Sizing Guide

- Take circumferential measurements to determine size (thigh measurement only needed for thigh and waist high stockings)
- Then take length measurements to determine if short or long fitting (only for 6000 and 7000 series)

Circumference				
Circumference	Small	Medium	Large	XLarge
Ankle	19 - 23 cm	23 - 26 cm	26 - 29 cm	29 - 31 cm
Calf	29 - 39 cm	33 - 42 cm	36 - 45 cm	39 - 47 cm
Below the knee	28 - 38 cm	32 - 41 cm	35 - 44 cm	38 - 46 cm
Thigh	48 - 63 cm	54 - 67 cm	58 - 72 cm	63 - 74 cm
Circumference				

Length (6000 & 7000 series only)		
Length	Short	Long
Knee	34 - 49 cm	39 - 44
Thigh	59 - 67 cm	68 - 78
Waist	67 - 74 cm	74 - 85
Length measurements required only for 6000 and 7000 ranges. All others have only one length.		
<ul style="list-style-type: none"> • Knee high - floor to 2cm below knee • Thigh high - floor to 5cm below groin • Waist high - floor to groin 		

To Order

Select Code, then Style, then Colour, then Size.

(eg. VEN4001AD/Open Toe/Mexico/Small)

See Next Page for Product Listing

Venosan - Medical Legwear Products

Full product list on next page



Venosan - Medical Legwear Products

DVA: RAP# AR22 For more information please refer to pg 7.

Compression	Code	Description	Style	Colour
VENOSAN 4000 - NYLON - UNISEX			Unisex - Soft, cool & comfortable micro fibre, suitable for all uses. One Length.	
4001 Series 18-22 mmHg	VEN4001AD	4001 Knee high	Open/closed toe	Mexico, Marokko, Black
	VEN4001AGH	4001 Thigh high (grip top)	Open toe with plain top Closed toe with plain top Closed toe with lace top	Mexico, Marokko, Black Marokko, Black Mexico, Marokko, Black
	VEN4001AT	4001 Waist high	Closed toe only	
4002 Series 23-32 mmHg	VEN4002AD	4002 Knee high	Open/closed toe	Mexico, Marokko, Black
	VEN4002AGH	4002 Thigh high (grip top)	Open toe with plain top Closed toe with plain top Closed toe with lace top	Mexico, Marokko, Black Marokko, Black Mexico, Marokko, Black
	VEN4002AGG	4002 Thigh/belt (single leg/belt)	Open toe only - Left/right	Mexico
	VEN4002AT	4002 Waist high	Closed toe only	Mexico, Marokko, Black

DVA: RAP# AR22 For more information please refer to pg 7.

VENOSAN 5000 UNISEX			Cotton blend with silver - anti fungal/bacterial. Suitable for those with dry flaky skin.	
5001 Series 18-22 mmHg	VEN5001AD	5001 Knee high (cotton blend w silver)	Open or Closed toe	Mexico, Marokko, Black
	VEN5001AGH	5001 Thigh high (grip top - cotton blend w silver)	Open toe with plain top Closed toe with lace top	Mexico, Marokko, Black Mexico, Marokko, Black
	VEN5001AGG	5001 Thigh / belt (single leg/belt - cotton blend w silver)	Open toe only - Left/right	Mexico, Marokko, Black
	VEN5001AT	5001 Waist high (cotton blend w silver)	Closed toe only	Mexico
5002 Series 23-32 mmHg	VEN5002AD	5002 Knee high (cotton blend w silver)	Open or Closed toe	Mexico, Marokko, Black
	VEN5002AGH	5002 Thigh high (grip top, cotton blend w silver)	Open toe with plain top Closed toe with plain top Closed toe with lace top	Mexico, Marokko, Black Mexico, Marokko, Black Mexico, Marokko, Black
	VEN5002AGG	5002 Thigh / belt (single leg/belt - cotton blend w silver)	Open toe only - Left/right	Mexico
	VEN5002AT	5002 Waist high (cotton blend w silver)	Closed toe only	Mexico, Marokko, Black
5003 Series 36-48 mmHg	VEN5003AD	5003 Knee high (cotton blend w silver)	Open or Closed	Mexico, Marokko, Black

DVA: RAP# AR22 For more information please refer to pg 7.

VENOSAN 6000 UNISEX			Unisex - economical - durable nylon/lycra - short and long fittings.	
6001 Series 18-22 mmHg	VEN6001AD	6001 Knee high	Open or Closed	Beige, Black
	VEN6001AGH	6001 Thigh high (plain grip top)	Open or Closed	Beige, Black
	VEN6001AT	6001 Waist high	Closed toe only	Beige, Black
6002 Series 23-32 mmHg	VEN6002AD	6002 Knee high	Open or Closed	Beige, Black
	VEN6002AGH	6002 Thigh high (plain grip top)	Open or Closed	Beige, Black
	VEN6002AT	6002 Waist high	Closed toe only	Beige, Black
6003 Series 36-48 mmHg	VEN6003AD	6003 Knee high	Open toe only	Beige
	VEN6003AGH	6003 Thigh high	Open toe only	Beige
	VEN6003AT	6003 Waist high	Open toe only	Beige

DVA: RAP# AR22 For more information please refer to pg 7.

VENOSAN 7000 UNISEX			Unisex - opeaque with high stiffness/durability - anti - fungal/bacterial.	
7002 Series 23-32 mmHg	VEN7002AD	7002 Knee high	Open/closed	Beige, Black
	VEN7002AGH	7002 Thigh high (plain grip top)	Open/closed	Beige, Black
	VEN7002AGG	7002 Thigh/belt (single leg with belt)	Open toe only - Left/Right	Beige
7003 Series 36-48 mmHg	VEN7003AD	7003 Knee high	Open/closed	Beige, Black
	VEN7003AGH	7003 Thigh high (plain grip top)	Open/closed	Beige, Black



Venosan - Medical Legwear Products

✓ DVA: RAP# AR22 For more information please refer to pg 7.

Compression	Code	Description	Style(s)	Colour
VENOSAN LEGLINE - FEMALE			Sheer, fashionable stocking for women.	
20 mmHg	VEN20AD	Legline 20 knee high	Closed toe only	Black, Sahara, Nude
	VEN20AGH	Legline 20 thigh high (Lace grip top)	Closed toe only	Black, Grey, Sahara, Nude
	VEN20AT	Legline 20 waist high	Closed toe only	Black, Grey, Sahara, Nude
30 mmHg	VEN30AD	Legline 30 knee high	Closed toe only	Black, Sahara, Nude
	VEN30AGH	Legline 30 thigh high (Lace grip top)	Closed toe only	Black, Sahara, Nude
	VEN30AT	Legline 30 waist high	Closed toe only	Black, Sahara, Nude

✓ DVA: RAP# AR22 For more information please refer to pg 7.

VENOSAN SILVERLINE			Anti - fungal/bacterial. Reduces risk of foot infections, athletes foot and foot odour.	
20-30 mmHg	VENVS494	Silverline knee high - male	Closed toe only	Black
	VENVS495	Silverline knee high - female	Closed toe only	Beige, Black

✓ DVA: RAP# AR22 For more information please refer to pg 7.

VENOSAN MICROFIBRE			Mild oedema, slight varicose veins, tired legs.	
15-20 mmHg	VENMC790	Microfibre knee high - male	Closed toe only	Black
	VENMC792	Microfibre knee high - female	Closed toe only	Beige, Black
18-22 mmHg	VENMC890	Microfibre knee high - male	Closed toe only	Black

✓ DVA: RAP# AR22 For more information please refer to pg 7.

VENOSAN PERLFOR			Flat knit with seam, cotton blend.	
23-32 mmHg	VENV232	Perflor knee high	Open toe only	Beige

Medi - Medical Legwear

To Order

Please quote product code and colour when ordering. (eg. MED185 / Navy)



Sizing Guide

- Take circumferential measurements to determine size (thigh measurement only needed for thigh and waist high stockings)
- Then take length measurements to determine if short or long fitting (only for 6000 and 7000 ranges)

Circumference

- Ankle - the narrowest point of the ankle, immediately above the ankle bone
- Calf - widest part of lower leg.
- Below-knee - circumference, around the leg, 2cm below the knee
- Thigh - top of leg, 5cm below the groin

Length (cm)

- Knee High - Floor to 2cm below knee
- Thigh/Waist High - Floor to 5cm below groin

Size Chart 1: MEDIVEN ELEGANCE - MEDIVEN COMFORT - MEDIVEN PLUS (UNISEX)

	CIRCUMFERENCE (cm)							LENGTH (cm)		
	I	II	III	IV	V	VI	VII	Style	Short	Regular
Ankle	18 - 20	20 - 22	22 - 24	24 - 26	26 - 28	28 - 30	30 - 32	Knee high	34 - 38	39 - 44
Calf	28 - 34	30 - 37	33 - 40	35 - 43	37 - 46	39 - 49	41 - 51	Thigh high	62 - 71	72 - 83
Calf - extra wide	34 - 38	37 - 41	40 - 44	42 - 46	44 - 48	46 - 50	48 - 52	Extra Wide Calf only available in Mediven Plus 30-40 knee highs - Beige only.		
Below knee	27 - 33	29 - 36	32 - 39	34 - 42	36 - 45	38 - 48	40 - 50			
Thigh - plain top	43 - 57	45 - 62	49 - 67	53 - 72	56 - 77	60 - 81	64 - 85			
Thigh - grip top	43 - 48	45 - 52	49 - 56	53 - 60	56 - 64	60 - 68	64 - 72			



Medi - Medical Legwear (cont.)

DVA: RAP# AR22 For more information please refer to pg 7.

MEDIVEN ELEGANCE - Refer Chart 1 (above) for Sizing

- Elegant, fashionable and versatile
- Colours: beige, caramel, light grey, navy, black, white, sand, grey (montana), siena, anthracite

Style	Length	20-30 mmHg		30-40 mmHg	
		Open Toe	Closed Toe	Open Toe	Closed Toe
Knee high	Reg	MED185	MED185	MED285	MED285
Knee high	Short	MED186	MED186	MED286	MED286
Thigh high - plain top	Reg	MED187	MED187	MED287	MED287
Thigh high - plain top	Short	MED188	MED188	MED288	MED288
Thigh high - grip top - female	Reg	MED189	MED189	MED289	MED289
Thigh high - grip top - female	Short	MED190	MED190	MED290	MED290
Waist high - pantyhose	Reg	MED191	MED191	MED291	MED291
Waist high - pantyhose	Short	MED192	MED192	MED292	MED292

DVA: RAP# AR22 For more information please refer to pg 7.

MEDIVEN COMFORT - Refer Chart 1 (above) for Sizing

- Highly elasticised opaque knit - Comfortable to wear.
- Colours: beige/black/sand/grey (montana)

Style	Length	20-30 mmHg		30-40 mmHg	
		Open Toe	Closed Toe	Open Toe	Closed Toe
Knee high	Reg	MEDZ14000	MEDZ14001	MEDZ24000	MEDZ24001
Knee high	Short	MEDZ14700	MEDZ14701	MEDZ24700	MEDZ24701
Thigh high - grip top - unisex	Reg	MEDZ16900	MEDZ16901	MEDZ26900	MEDZ26901
Thigh high - grip top - unisex	Short	MEDZ15900	MEDZ15901	MEDZ25900	MEDZ25901
Thigh high - grip top - female	Reg	MEDZ16H00	MEDZ16H01	MEDZ26H00	MEDZ26H01
Thigh high - grip top - female	Short	MEDZ15H00	MEDZ15H01	MEDZ25H00	MEDZ25H01
Waist high - pantyhose	Reg	MEDZ11000	MEDZ11001	MEDZ21000	MEDZ21001
Waist high - pantyhose	Short	MEDZ11700	MEDZ11701	MEDZ21700	MEDZ21701

DVA: RAP# AR22 For more information please refer to pg 7.

MEDIVEN PLUS (UNISEX) - Refer Chart 1 (above) for Sizing

- Soft but durable w/ Antibacterial action for fresher feet
- Colours: beige/black/caramel

Style	Length	20-30 mmHg		30-40 mmHg		40-50 mmHg	
		Open Toe	Closed Toe	Open Toe	Closed Toe	Open Toe	Closed Toe
Knee high	Reg	MED101	MED101	MED201	MED201	MED401	MED401
Knee high	Short	MED102	MED102	MED202	MED202	MED402	MED402
Knee high - extra wide	Reg	-	-	MED203	MED203	-	-
Knee high - extra wide	Short	-	-	MED204	MED204	-	-
Thigh high - plain top	Reg	MED107	MED107	MED206	MED206	MED404	MED404
Thigh high - plain top	Short	MED105	MED105	MED205	MED205	MED403	MED403
Thigh high - grip top - unisex	Reg	MED108	MED108	MED200	MED200	MED400	MED400
Thigh high - grip top - unisex	Short	MED106	MED106	MED199	MED199	MED399	MED399
Thigh high - CHAPS - single leg left	Reg	MED119	MED119	MED209	MED209	MED406	MED406
Thigh high - CHAPS - single leg left	Short	MED120	MED120	MED210	MED210	MED408	MED408
Thigh high - CHAPS - single leg right	Reg	MED117	MED117	MED207	MED207	MED405	MED405
Thigh high - CHAPS - single leg right	Short	MED118	MED118	MED208	MED208	MED407	MED407
Waist high - pantyhose	Reg	MED109	MED109	MED211	MED211	MED409	MED409
Waist high - pantyhose	Short	MED110	MED110	MED212	MED212	MED410	MED410



Medi - Medical Legwear (cont.)

Size Chart 2: MEDIVEN FORTE

	CIRCUMFERENCE (cm)							LENGTH (cm)		
	I	II	III	IV	V	VI	VII	Style	Short	Regular
Ankle	18 - 20	20 - 22	22 - 24	24 - 26	26 - 28	28 - 30	30 - 32	Knee high	33 - 37	39 - 44
Calf	29 - 34	31 - 36	33 - 38	35 - 40	37 - 42	39 - 44	41 - 46	Thigh high	62 - 71	72 - 83
Thigh - plain top	28 - 33	30 - 35	32 - 37	34 - 39	36 - 41	38 - 43	40 - 45	Extra Wide Calf available on request. Beige only.		
Thigh - grip top	44 - 53	46 - 57	50 - 61	53 - 65	56 - 70	60 - 74	64 - 80			

DVA: RAP# AR22 For more information please refer to pg 7.

MEDIVEN FORTE (UNISEX) - Refer Chart 2 (above) for Sizing

Style	Length	30-40 mmHg	40-50 mmHg
		Open Toe	Open Toe
Knee high	Reg	MED320	MED330
Knee high	Short	MED321	MED331
Thigh high - plain top	Reg	MED323	MED333
Thigh high - plain top	Short	MED322	MED332
Thigh high - CHAPS - single leg left	Reg	MED326	MED336
Thigh high - CHAPS - single leg left	Short		
Thigh high - CHAPS - single leg right	Reg	MED324	MED334
Thigh high - CHAPS - single leg right	Short		
Waist high - pantyhose	Reg	F21000	F31000
Waist high - pantyhose	Short	F21700	F31700

SizeChart 3: DUOMED

	CIRCUMFERENCE (cm)					LENGTH (cm)		
	S	M	L	XL	XXL	Length	Short	Regular
Ankle	19 - 21	22 - 24	25 - 27	28 - 30	30 - 32	Knee high	33 - 37	39 - 44
Calf	28 - 34	32 - 38	36 - 42	40 - 46	42 - 50	Thigh high	62 - 71	72 - 83
Thigh - plain top	42 - 57	48 - 64	54 - 71	60 - 68	65 - 85			
Thigh - grip top	47 - 54	52 - 60	56 - 65	62 - 72	65 - 76			

DVA: RAP# AR22 For more information please refer to pg 7.

DUOMED - Refer Chart 3 (above) for Sizing

- Economical, functional and durable
- Colours - beige/black

Style	Length	20-30 mmHg		30-40 mmHg	
		open Toe	Closed Toe	Open Toe	Closed Toe
Knee high	Reg	MEDV14000	MEDV14001	MEDV24000	MEDV24001
Knee high	Short	MEDV14700	MEDV14701	MEDV24700	MEDV24701
Thigh high - plain top	Reg	MEDV16000		MEDV26000	
Thigh high - plain top	Short	MEDV15000		MEDV25000	
Thigh high - grip top - unisex	Reg	MEDV16100	MEDV16101	MEDV26100	MEDV26101
Thigh high - grip top - unisex	Short	MEDV15100	MEDV15101	MEDV25100	MEDV25101
Thigh high - CHAPS - single leg left	Reg			MEDV26200	
Thigh high - CHAPS - single leg left	Short			MEDV25200	
Thigh high - CHAPS - single leg right	Reg			MEDV26300	
Thigh high - CHAPS - single leg right	Short			MEDV25300	
Waist high - pantyhose	Reg	MEDV11000	MEDV11001		MEDV21001
Waist high - pantyhose	Short	MEDV11700	MEDV11701		MEDV21701



TED anti-embolism legwear

- TED anti-embolism stockings with graduated compression are designed to ensure optimum blood flow velocity when the wearer is immobile in bed for long periods of time
- They are widely used in hospitals for non-ambulatory or convalescing persons to avoid the danger of thromboembolic disease (blood clotting)
- Unless otherwise instructed by the physician, these stockings should be worn at all times while in hospital except when showering or bathing
- Available in knee high, thigh high with grip top, and thigh high with waistbelt (in pairs)
- TED stockings are full-foot, but feature an inspection opening under the toes
- Inlay circumferential knit helps assure a proper pressure pattern and helps to prevent slippage
- These TED stockings are unisex, and are available in white



TED Product Overview & Sizing Guide

THIGH HIGH - with Waistbelt

- The TED thigh high with waist belt is very suitable for thin or obese patients, where stocking slippage is often a problem
- One-piece, snap - on belt is easily adjustable
- Pressure break at knee, protecting the critical popliteal area and promoting free leg movement in the recumbent patient
- Available in 5 sizes, with choice of either regular or long fit
- Supplied per pair

	Calf	Thigh	Leg length, heel to groin	
			Reguar	Long
XSmall	to 25.4	to 63.5	to 71.1	71.1+
Small	25.4 - 30.5	to 63.5	to 72.4	72.4+
Medium	30.5 - 38.1	to 63.5	to 72.4	72.4+
Large	38.1 - 44.5	to 63.5	to 73.7	73.7+
XLarge	38.1 - 44.5	63.5 - 81.3	to 72.4	72.4+

- Calf measurement around widest part of lower leg
- Thigh measurement around thigh at top of leg
- Length from heel to gluteal furrow (just below the groin)

THIGH HIGH - Grip Top

- Thigh length with grip top
- Pressure break at knee, protecting the critical popliteal area and promoting free leg movement in the recumbent patient
- Available in 5 sizes, with choice of either, short, regular or long fit

	Calf	Thigh	Leg length, heel to groin		
			Short	Reguar	Long
Small	to 30.5	to 63.5	to 73.7	73.7 - 83.8	83.8+
Medium	30.5 - 38.1	to 63.5	to 73.7	73.7 - 83.8	83.8+
Large	38.1 - 44.5	to 63.5	to 73.7	73.7 - 83.8	83.8+
XLarge	44.5 - 54.6	63.5 - 81.3	to 73.7	73.7 - 83.8	83.8+
XXLarge	54.6 - 66.0	81.3 - 91.4	to 73.7	73.7 - 83.8	83.8+

- Calf measurement around widest part of lower leg
- Thigh measurement around thigh at top of leg
- Length from heel to gluteal furrow (just below the groin)
- If thigh exceeds 91.4cm, select knee length style



TED anti-embolism legwear (cont.)

KNEE HIGH			
<ul style="list-style-type: none"> TED knee high stockings are designed to reduce venous stasis below the knee when thigh length styles are medically contraindicated Knee length with soft top band to minimise slippage without constricting circulation Available in 6 sizes, with choice of either regular or long fit 			
	Calf (cm)	Leg length, heel to Knee	
		Reguar	Long
Small	to 30.5	to 40.6	40.6+
Medium	30.5-38.1	to 43.2	43.2+
Large	38.1-44.5	to 45.7	45.7+
X Large	44.5-50.8	to 45.7	45.7+
XX Large	50.8-58.4	to 45.7	45.7+
XXX Large	58.4-66.0	to 45.7	45.7+
<ul style="list-style-type: none"> Calf measurement around widest part of lower leg Length from heel to bend in back of knee 			

Note: if one measurement indicates a larger size than the other, select the larger size.

Note: In thigh length stockings, when applied, the stitch change (change in fabric sheerness) should fall between 2.5 to 5cm below the bend in the knee.

To Order

Please quote product code when ordering.

DVA: RAP# AR22 For more information please refer to pg 7.

TED Thigh High w/ Waistbelt		TED Thigh High w/ Grip Top		TED Knee High	
KD3306	Regular / XSmall	KD3071LF	Small/short	KD7071	Regular / Small
KD3039	Regular / Small	KD3310LF	Medium/short	KD7115	Regular / Medium
KD3144	Regular / Medium	KD3634LF	Large/short	KD7203	Regular / Large
KD3221	Regular / Large	KD3180	XLarge/short	KD7604	Regular / XLarge
KD3922	Regular / XLarge	KD3183	XXLarge/short	KD7470	Regular / XXLarge
KD3320	XSmall/long	KD3130LF	Regular / Small	KD7472	Regular / XXXLarge
KD3364	Small/long	KD3416LF	Regular / Medium	KD7339	Small/long
KD3449	Medium/long	KD3728LF	Regular / Large	KD7480	Medium/long
KD3523	Large/long	KD3181	Regular / XLarge	KD7594	Large/long
KD3995	XLarge/long	KD3184	Regular / XXLarge	KD7802	XLarge/long
		KD3222LF	Small/long	KD7471	XXLarge/long
		KD3549LF	Medium/long	KD7473	XXXLarge/long
		KD3586LF	Large/long		
		KD3182	XLarge/long		
		KD3185	XXLarge/long		

TED Continuing Care anti-embolism legwear

Application

- Designed for the continuing care of the recuperating patient after leaving hospital
- To be worn only on physician's advice and during the time period recommended

Features

- Unisex, knee length, closed toe without inspection opening
- Available in 4 ankle sizes, with choice of either regular or long fit
- Supplied per pair. Colour: beige, white, black

SIZING GUIDE		CIRCUMFERENCE	
Size	Calf Circumference (cm)	Leg length, heel to knee (cm)	
		Reguarl	Large
Small	to 30.5	to 40.6	40.6+
Medium	30.5 - 38.1	to 43.2	43.2+
Large	38.1 - 44.5	to 45.7	45.7+
XLarge	44.5 - 50.8	to 45.7	45.7+
<ul style="list-style-type: none"> Calf measurement around widest part of lower leg Length from heel to bend in back of knee 			

Pressure Care & Circulation



TED anti-embolism legwear (cont.)

To Order

Please quote product code when ordering.

DVA: RAP# AR22 For more information please refer to pg 7.

	Beige	White	Black
Small/regular	KD4265	KD4278	KD4434
Medium/regular	KD4271	KD4279	KD4435
Large/regular	KD4289	KD4280	KD4436
XLarge regular	KD4296	KD4281	KD4437
Small/long	KD4317	KD4282	KD4572
Medium/long	KD4323	KD4283	KD4573
Large/long	KD4335	KD4284	KD4574
XLarge/long	KD4344	KD4285	KD4575

Solaris



Ready Wrap - Inelastic Compression

- ReadyWrap garments are designed to aid people living with venous disease or insufficiencies
- ReadyWrap Professional and ReadyWrap Quick-Fit are both made with inelastic, foam-backed fabric, along with a 50% strap overlap to mimic traditional bandaging
- Created to replace daytime compression bandaging, or serve as an alternative or supplement to elastic compression stockings
- Inelastic materials produce high working pressure and low resting pressure
- Breathable and wickable materials ensure maximum comfort
- Silver microfibre under-garment liner is available for added comfort
- Contraindications: arterial insufficiency or degeneration, deep vein thrombosis, untreated congestive heart failure, localized or systemic infection, or cancer, absent or severely impaired sensation

DVA: RAP# AR22 For more information please refer to pg 7.

Ready Wrap Professional Calf	Ready Wrap Quick-Fit Calf
<ol style="list-style-type: none"> 1. Gusset allows easy donning/doffing 2. Extra padding over tibia for comfort 3. Posterior straps allow pre-setting by therapist to desired compression. Patient can then remove/apply the garment while retaining the original compression level 4. 50% overlap to mimic non-elastic bandaging 5. Breathable & wickable fabric 	<ol style="list-style-type: none"> 1. Alternating Velcro closure straps ensure equalized torque 2. 50% overlap to mimic non-elastic bandaging. Quick and easy removal and application 3. Foam-laminated fabric 4. Breathable & wickable fabric



Order By

Code/Size/Length.

DVA: RAP# AR22 For more information please refer to pg 7.

Model	Size	To Fit	Reg	Long
Code: RP-LE-BD				
Professional calf	Small	To fit ankle 15 - 23/calf 28 - 38	30	35
Professional calf	Medium	To fit ankle 20 - 28/calf 38 - 48	30	35
Professional calf	Large	To fit ankle 25.5 - 33/calf 48 - 58	30	35
Code: RQ-LE-BD				
Quick-Fit calf	Small	To fit ankle 15 - 23/calf 28 - 38	30	35
Quick-Fit calf	Medium	To fit ankle 20 - 28/calf 38 - 48	30	35
Quick-Fit calf	Large	To fit ankle 25.5 - 33/calf 48 - 58	30	35
Quick-Fit calf	XLarge	To fit ankle 30.5 - 38/calf 58 - 68	30	35
Code: LN-LE-AD				
Liner	Universal	For calf garment, silver microfibre	Max girth 75cm	

Note: If ankle and calf measurements indicate different sizes, select the larger size.

Ready Wrap Professional Foot



Ready Wrap Quick-Fit Foot



1. 50% overlap of the strapping mimics bandaging protocols without the time and frustration of traditional bandaging
2. Extra padding over the dorsal aspect ensures that there is no unnecessary, uncomfortable compression
3. Patent - pending gusset allows for easy application and removal, and consistent compression
4. Manufactured with soft, comfortable, inelastic foam-laminated fabric that is breathable and wickable
5. Alternating Velcro closure straps ensure equalized torque

Order By

Code/Size.

DVA: RAP# AR22 For more information please refer to pg 7.

Model	Size	To Fit
Code: RE-LE-AB		
Professional foot	Small	To fit foot length 21/ankle 15 - 23
Professional foot	Medium	To fit foot length 23/ankle 20 - 28
Professional foot	Large	To fit foot length 26/ankle 25.5 - 33
Code: RO-LE-AB		
Quick-Fit foot	Small	To fit foot length 21/ankle 15 - 23
Quick-Fit foot	Medium	To fit foot length 23/ankle 20 - 28
Quick-Fit foot	Large	To fit foot length 26/ankle 25.5 - 33
Quick-Fit foot	XLarge	To fit foot length 29/ankle 30.5 - 38



Compression Armsleeve Overview

What is Lymphoedema

- If the lymphatic system is damaged or blocked, excess fluid, which would normally be drained away by the lymphatics, can build up in the tissues (most commonly the arms or legs)
- Lymphoedema in the upper limb is frequently a consequence of surgery or radiotherapy relating to breast cancer, resulting in fluid build-up in the arm, and often the hand

Importance of Compression in the treatment of Lymphoedema

Compression is an important adjunct to ongoing professional treatment of the affected limb. Compression plays a major role in the treatment of lymphoedema by encouraging lymph flow.

Your lymphoedema therapist will advise you on the style and compression appropriate for your particular needs.

INDICATORS	
20-30mmHg (class 1)	30-40mmHg (class 2)
<ul style="list-style-type: none"> • Treatment of primary and secondary lymphoedema in stages 1 and 2 of the arm with permanent or partial oedema of the hand • Post-operative (eg. mastectomy) and post-traumatic oedema • Blood poisoning and burn therapy 	

Styles Available

- The diagrams below depict the most commonly used styles of armsleeves and handpieces
- Not all of these styles are available in every brand - The type of top selected (Plain or Grip) is a personal preference

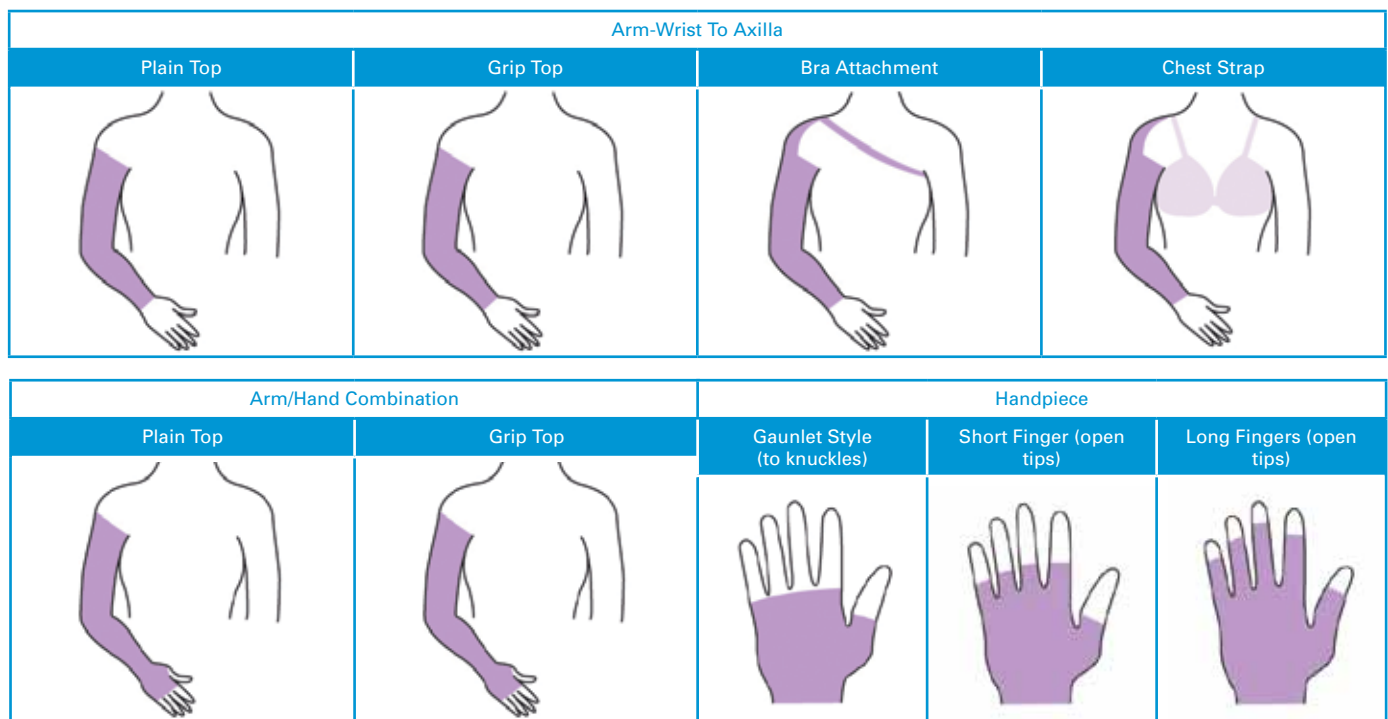

Selection

- Ensure correct measurements are taken, and that the garment is not too tight or loose
- Advise the therapist of any pain, swelling or colour change of the hand or fingers, or numbness in any part of the limb

Fitting Guide

- Never allow the top of the sleeve to roll or double-over. If there seems to be excess material, ease it gently down the arm until the top is flat against the skin, and ensure no creases or wrinkles remain

✓ RAP #	DVA Approval Rules	Eligible Prescriber*
AR22	Limit of 3 every 6 months	S, RN, Physio, OT, LMO
DVA Comments	*For lymphoedema garments, health providers should have specialist post graduate training in oedema/lymphoedema management in order to access, measure, fit and review these garments.	



GloriaMed



Sizing Guide

Size	CIRCUMFERENCE			LENGTH	
	Wrist	Forearm	Axilla	Length	Arm
Small	15 - 17 cm	21 - 25 cm	25 - 30 cm	Short	41 - 46 cm
Medium	17 - 19 cm	24 - 28 cm	29 - 34 cm	Long	46 - 52 cm
Large	19 - 21 cm	27 - 31 cm	33 - 38 cm	<ul style="list-style-type: none"> Length: from wrist to top of arm 	
XLarge	21 - 23 cm	30 - 34 cm	37 - 42 cm		

- Wrist: measurement around narrowest part of wrist
- Forearm: measurement around upper forearm at fullest point
- Axilla: measurement around top of arm just below armpit

To Order

Please quote product code and size when ordering (eg. G101/Medium/Long)

DVA: RAP# AR22 For more information please refer to pg 7.

Armsleeve - Wrist to Axilla		20-30	30-40
Plain topband	Short	G101	G201
Plain topband	Long	G101L	G201L
Shoulder strap	Short	G102	G202
Shoulder strap	Long	G102L	G202L

Jobst - Ready to Wear



Overview

- Jobst Ready to wear armsleeve and handpiece combination can be worn separately or together
- These products fit either the left or right arm/hand and are available in 3 sizes
- The lightweight knit construction ensures air permeability and comfort

Sizing Guide

MEASUREMENTS REQUIRED (cm)				
Armsleeve	Circumference	Small	Medium	Large
Wrist	Narrowest part of wrist	14 - 20 cm	16 - 22 cm	18 - 24 cm
Arm (mid - lower)		18 - 23 cm	23 - 29 cm	29 - 23 cm
Arm (mid - upper)		22 - 40 cm	27 - 45 cm	33 - 51 cm
Handpiece				
Palm	Widest part of hand	15 - 19 cm	19 - 22 cm	22 - 26 cm
Wrist	Narrowest part of wrist	14 - 20 cm	16 - 22 cm	18 - 24 cm

To Order

Please quote product code when ordering.

DVA: RAP# AR22 For more information please refer to pg 7.

		20-30		
Armsleeve - Wrist to Axilla		Small	Medium	Large
Jobst ready to wear - plain topband	Code	75276 - 00	75277 - 00	75278 - 00
Handpiece				
Jobst ready to wear - handpiece	Code	75282 - 00	75283 - 00	75284 - 00



Jobst - Elvarex

- JOBST Elvarex garments feature a special low-stretch, 'double-knit' fabric, which exerts a light massaging effect on the initial lymphatics, and minimizes re-oedematisation
- The high cotton content, flat knit construction and short stretch thread means that Elvarex products provide a good anatomical fit with maximum comfort

Sizing Guide

Armsleeve	Circumference	Small	Medium	Large
Wrist	Narrowest part of wrist	160 - 180 mm	180 - 200 mm	200 - 230 mm
Arm (mid - lower)		230 - 260 mm	260 - 280 mm	280 - 300 mm
Elbow	Around the elbow crease	240 - 260 mm	260 - 290 mm	290 - 320 mm
Arm (mid - upper)		260 - 290 mm	290 - 330 mm	330 - 370 mm
Top of arm	Top of arm, just below armpit	310 - 340 mm	340 - 380 mm	380 - 440 mm
Handpiece				
Hand	At knuckles	160 - 180 mm	175 - 195 mm	195 - 205 mm
Palm	Widest part of hand	170 - 190 mm	190 - 210 mm	210 - 230 mm
Wrist	Narrowest part of wrist	160 - 180 mm	180 - 200 mm	200 - 220 mm
Thumb	Around the base of thumb	50 - 60 mm	60 - 70 mm	70 - 80 mm
Handpiece with Fingers				
	As for Handpiece, plus...			
Index finger	Around base of finger	50 - 60 mm	60 - 70 mm	60 - 70 mm
Middle finger	Around base of finger	50 - 60 mm	60 - 70 mm	65 - 70 mm
Ring finger	Around base of finger	45 - 55 mm	55 - 65 mm	65 - 75 mm
Little finger	Around base of finger	40 - 50 mm	50 - 60 mm	60 - 70 mm

To Order

For Jobst Elvarex product codes, add the 2 digit size code to the 5 digit product code prefix.

Please quote product code when ordering (eg. 76101 - 01)

DVA: RAP# AR22 [For more information please refer to pg 7.](#)

		20-30					
		Small		Medium		Large	
Armsleeve - Wrist to Axilla		Left	Right	Left	Right	Left	Right
Jobst Elvarex armsleeve	76101 -	01	00	03	02	05	04
Jobst Elvarex armsleeve with shoulder strap	79435 -	07	06	09	08	11	10
Jobst Elvarex armsleeve with bra attachment	79435 -	01	00	03	02	05	04
Handpiece							
Jobst Elvarex handpiece with thumbs	76091 -	01	00	03	02	05	04
Jobst Elvarex handpiece with full fingers	76901 -	07	06	09	08	11	10

Venosan



Sizing Guide

ARMSLEEVE CIRCUMFERENCE				ARMSLEEVE LENGTH		HANDPIECE	
Size	Wrist	Forearm	Axilla	Length	Arm		
Small	14 - 17 cm	22 - 26 cm	24 - 30 cm	Regular	35 - 45 cm	Small	16 - 19 cm
Medium	17 - 20 cm	26 - 30 cm	30 - 36 cm	Long	40 - 50 cm	Medium	19 - 22 cm
Large	20 - 23 cm	30 - 34 cm	36 - 42 cm	<ul style="list-style-type: none"> • Length: from wrist to top of arm 		Large	22 - 25 cm
XLarge	23 - 26 cm	34 - 38 cm	42 - 48 cm			<ul style="list-style-type: none"> • Hand: measurement around widest part of hand at knuckles 	
<ul style="list-style-type: none"> • Wrist: measurement around narrowest part of wrist • Forearm: measurement around upper forearm • Axilla: measurement around top of arm just below armpit 							



Venosan (cont.)

To Order

Order by product code and size when ordering (eg. VEN7002ZG/Larger/Long)

DVA: RAP# AR22 For more information please refer to pg 7.

Armsleeve - Wrist to Axilla	20-30	30-40
7002- Plain topband	-	VEN7002CG
7002 - Silicon topband	-	VEN7002CHG
4002 - Plain topband	-	VEN4002BG
Armsleeve/Hand Combined	20-30	30-40
7002- Plain topband	-	VEN7002ZG
7002 - Silicon topband	-	VEN7002ZGH
Handpiece (Gauntlet Style)	20-30	30-40
Short (1/4) fingers	VENYB	-
Long (3/4) fingers	VENXB	-

Medi

Sizing Guide (Mediven & Medien 95)



		MEASUREMENTS REQUIRED							Note: size I - only available in Medi 95 armsleeve.
Armsleeve	Circumference	I	II	III	IV	V	VI	VII	
Wrist	Narrowest part of wrist	11 - 13 cm	13 - 15 cm	15 - 17 cm	17 - 19 cm	190- 21 cm	21 - 230cm	23 - 25 cm	
Elbow	Around the elbow crease	17 - 23 cm	20 - 26 cm	23 - 29 cm	26 - 32 cm	29 - 35 cm	32 - 38 cm	35 - 41 cm	
Top of arm	Top of arm, just below armpit	19 - 26 cm	22 - 29 cm	25 - 32 cm	29 - 36 cm	33 - 40 cm	37 - 44 cm	41 - 48 cm	
Armsleeve/Hand Combo... as above, plus									
Palm	Widest part of hand	-	16 - 19 cm	18 - 21 cm	20 - 23 cm	22 - 25 cm	24 - 27 cm	26 -29 cm	
Handpiece									
Hand	At knuckles	-	16 - 190 cm	18 - 21 cm	20 - 23 cm	22 - 25 cm	24 - 27 cm	26 - 29 cm	
Palm	Widest part of hand	-	16.5 - 20 cm	18.5 - 22 cm	20.5 - 24 cm	22.5 - 26 cm	24.5 - 28 cm	26.5 - 30 cm	
Wrist	Narrowest part of hand	-	13 -15 cm	15 -17 cm	17 - 19 cm	19 - 21 cm	21 - 23 cm	23 - 25 cm	
Above wrist		-	14 -16.5 cm	16 - 18.5 cm	18 - 20.5 cm	20 - 22.5 cm	22 - 24.5 cm	24 - 26.5 cm	
Thumb	Around the base of thumb	-	6.5 cm	7.5 cm	8.5 cm	9.5 cm	10.5 cm	11.5 cm	
Handpiece with fingers... as above, plus									
Index finger	Around the base of finger	-	5.5 cm	6.5 cm	7.5 cm	8.5 cm	9.5 cm	10.5 cm	
Middle finger	Around the base of finger	-	5.5 cm	6.5 cm	7.5 cm	8.5 cm	9.5 cm	10.5 cm	
Ring finger	Around the base of finger	-	5 cm	6 cm	7 cm	8 cm	9 cm	10 cm	
Little finger	Around the base of finger	-	4.5 cm	5.5 cm	6.5 cm	7.5 cm	8.5 cm	9.5 cm	



Mediven & Mediven 95

Overview

- MEDIVEN armsleeves feature a seamless open knit construction which minimises perspiration and allows natural body heat transfer.
- MEDIVEN 95 garments feature a seamless fine mesh construction, giving ease of handling, and are soft and comfortable to wear. These garments enjoy excellent compliance with lymphoedema patients.

To Order

Order by product code and size when ordering (eg. MED711/Long)

MEDIVEN		DVA: RAP# AR22 For more information please refer to pg 7.	
Armsleeve - Wrist to Axilla		20-30	30-40
Mediven - plain topband	Standard	MED710	MED712
Mediven - plain topband	Long	MED711	MED713
Mediven - with shoulder strap	Standard	MED738	MED742
Mediven - with shoulder strap	Long	MED739	MED743
Armsleeve/Hand Combined		20-30	30-40
Mediven - plain topband	Standard	MED730	MED732
Mediven - plain topband	Long	MED731	MED733
Mediven - with shoulder strap	Standard	MED740	MED744
Mediven - with shoulder strap	Long	MED741	MED745
Handpiece		20-30	30-40
Mediven - handpiece - without fingers	-	MED720	MED722
Mediven - handpiece - long fingers/open tips	-	-	MED723

MEDIVEN 95		DVA: RAP# AR22 For more information please refer to pg 7.	
Armsleeve - Wrist to Axilla		20-30	30-40
Medi 95 - plain topband	Standard	MED714	MED716
Medi 95 - plain topband	Long	MED715	MED717
Medi 95 - silicon topband	Standard	MED746	MED750
Medi 95 - silicon topband	Long	MED747	MED751
Armsleeve/Hand Combined		20-30	30-40
Medi 95 - plain topband	Standard	MED752	MED756
Medi 95 - plain topband	Long	MED753	MED733
Medi 95 - silicon topband	Standard	MED754	MED758
Medi 95 - silicon topband	Long	MED755	MED759
Handpiece		20-30	30-40
Medi 95 - handpiece - long fingers/open tips	-	-	MED761



Isotoner Therapeutic Pressure Gloves (pr)

- Washable lycra and spandex blend gives Isotoner gloves a comfortable fit while controlling swelling
- Use this glove anytime day or night and the gentle, even compression will soothe and reduce swollen aching hands
- Seamless support-seams are on the outside and away from pain-sensitive areas like the base of the thumb



✓ DVA: RAP#: AR22 [For more information please refer to pg 7.](#)

Code Open Finger	Code Full Finger	Size	(cm)
NC53022 - 1	NC52023 - 1	S	17 - 19
NC53022 - 2	NC52023 - 2	M	19 - 22
NC53022 - 3	NC52023 - 3	L	22 - 24

Measure (cm) around palm (widest part of hand).

- 2-way stretch provides gentle compression
- Isotoner therapeutic glove compression is considered moderate: 23 - 32mm Hg

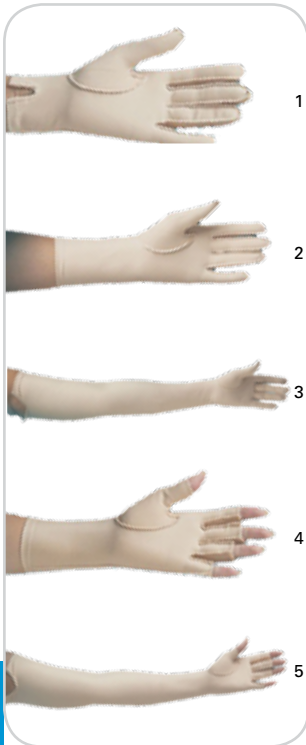

Norco Oedema Glove (ea)

✓ DVA: RAP#: AR22 [For more information please refer to pg 7.](#)

Full Finger							
1. Wrist		2. Over Wrist		3. Full Arm		Size	(cm)
Left	Right	Left	Right	Left	Right		
		NC53210	NC53211			XS	18
NC53200	NC53201	NC53212	NC53213	NC53240	NC53251	S	20
NC53202	NC53203	NC53214	NC53215	NC53242	NC53253	M	23
NC53204	NC53205	NC53216	NC53217	NC53244	NC53255	L	25
Open Finger							
4. Over Wrist		5. Full Arm		Size	(cm)		
Left	Right	Left	Right				
NC53220	NC53221			XS	18		
NC53222	NC53223	NC53250	NC53251	S	20		
NC53224	NC53225	NC53252	NC53253	M	23		
NC53226	NC53227	NC53254	NC53255	L	25		

Measure (cm) around palm (widest part of hand).

- Made of nylon/lycra with seams on the outside for smooth oedema control
- Mild compression 15 - 25mmHg
- Closed finger style available in wrist length, over-the-wrist, or full arm styles
- Open finger styles available in over-the-wrist and full arm styles
- Sold individually



Handeze Support Gloves (pr) - Beige Or Slate

✓ DVA: RAP#: AR22 [For more information please refer to pg 7.](#)

Code Beige	Code Slate	Size	(cm)
2HGP S0	2HGP G0	XS	Up to 7.0
2HGP S1	2HGP G1	S	6.5 - 8.0
2HGP S2	2HGP G2	M	7.5 - 9.5
2HGP S3	2HGP G3	L	8.5 - 11.0

Measure the width hand across the four knuckles (not finger joints). Do not include the thumb.

- The unique four-way stretch fabric provides three main proven pain relievers: heat, support and massage
- The Handeze glove traps natural body heat, which stimulates blood circulation in wrist, hand and fingers. This reduces swelling and helps maintain flexibility
- Made of modified lycra fabric

- The form-fitting design provides additional support for the muscles, tendons and ligaments of the hand and wrist



Solaris Tribute - Nightware Lymphoedema Garments

- Tribute custom-designed NightWear garments are essential for a successful lymphoedema home management program
- Worn nightly, Tribute garments eliminate the need for complex bandaging, and offer an effective solution to help regulate fluid fluctuations, decrease tissue turgor, assist a weakened lymphatic system, and maintain gains made in therapy
- Foam-filled channels in the garments create localised tissue stretch and pressure differential, opening the initial lymphatic gaps to encourage re-absorption of interstitial fluids and particles

DVA: RAP# AR22 For more information please refer to pg 7.

Code	Tribute Nightware Lymphoedema Garments	Style
UE - AG	Nightwear lymphoedema garment - 20mmHg	Fingertips to axilla
LE - AD - V/C	Nightwear lymphoedema garment - 20mmHg	Toes to knee



Solaris Caresia - Lymphoedema Compression Bandage Liners

- Caresia standard sized bandage liners simplify complex multi-layered bandaging protocols by replacing and improving upon foam liners, stockinette, and gauze. Simply don the Caresia, and wrap with 1-2 layers of short-stretch bandages over the top
- Caresia over-wrapping is more comfortable and effective than standard bandaging during the active phase of therapy
- The unique foam chips used in every Caresia garment help resolve tissue induration, stimulate interstitial fluid movement, and diffuse irregular wrapping pressures. The foam also helps provide padding protection to limbs.

DVA: RAP# AR22 For more information please refer to pg 7.

Code	Caresia Compression Bandage Liners	Style
CR-UE-BG	Caresia lymphoedema liner	Arm
CR-UE-AC	Caresia lymphoedema liner	Glove
CR-UE-BC	Caresia lymphoedema liner	Gauntlet
CR-LE-AD	Caresia lymphoedema liner	Leg
CR-LE-DG	Caresia lymphoedema liner	Thigh
CR-LE-AB	Caresia lymphoedema liner	Foot



Solaris Swell Spots - Lymphoedema Pressure Pads

- Designed to be used under compression bandaging, to address areas of swelling, pad bony prominences, soften scars, or fill crevices
- Both tailored (breast, foot, ankle, patella, thigh etc), and multi-function types are available to be used wherever is appropriate.

DVA: RAP# AR22 For more information please refer to pg 7.

Code	Solaris Swell Spots	Code	Solaris Swell Spots
SP-01	Swell spot - curved	SP-11	Swell spot - thora - thigh
SP-02	Swell spot - dorsal	SP-13	Swell spot - crescent
SP-03	Swell spot - palmar	SP-14	Swell spot - we'a toe
SP-04	Swell spot - oval	SP-15-F	Swell spot - female libia
SP-05-S	Swell spot - katina small	SP-15-M	Swell spot - male scrotum
SP-05-L	Swell spot - katina large	SP-16-A	Swell spot - lateral bra
SP-06	Swell spot - sobol	SP-17	Swell spot - lt knee shaper
SP-07	Swell spot - jo-ju	SP-19	Swell spot - sweet spot
SP-08	Swell spot - kimbe	SP-20-S	Swell spot - tic tac small
SP-09	Swell spot - breast	SP-20-M	Swell spot - tic tac medium
SP-10	Swell spot - versi - face	SP-20-L	Swell spot - tic tac large





Flowtron 'Hydroven 3' Compression Pump

hydroven

Application

- The 'Hydroven 3' intermittent pneumatic compression system treats a wide variety of vascular and lymphatic conditions, including venous ulceration, dependent and traumatic oedema and chronic venous insufficiency
- Client should be assessed by a qualified medical professional before using this product.

Features

- Clinically effective, non-invasive dynamic compression to the limbs
- Efficient use in both the clinic or home environment
- Three chamber leg or arm compression
- Adjustable pressure control provides tailored therapy to suit individual patients needs
- Pressure range of 30-110mmHg
- Inflation/deflation cycle time of 90 seconds each
- Secure snap-lock connection of all garments to the pump promotes easy set up and prevents accidental disconnection, and single tube attachment to each garment ensures less clutter

DVA: RAP# AR23 For more information please refer to pg 7.

Product	Code	
'Hydroven 3' Pump	51009AU	
Garments	Limb Garment	Inserts
Half leg 50cm	5103L50	5103LI50
Full leg 66cm	5103L66	5103LI66
Full leg 71cm	5103L71	5103LI71
Full leg 76cm	5103L76	5103LI76
Full leg 84cm	5103L84	5103LI84
Full leg 92cm	5103L92	5103LI92
Full arm 68cm	5103A68	5103AI68
Full arm 78cm	5103A78	5103AI78

Garments

- Hydroven's triple-chamber arm and leg garments provide gradient sequential compression, with 10% reduction in pressure in each chamber distally to proximally
- All garments can be used on either left or right limb, or two units can be used concurrently on both limbs



'Compress' Sequential Compression Pump Kit

Application

- This device may be prescribed for post phlebotic syndrome, varicose veins, varicosities of pregnancy, leg ulcers, venous ligation, knee/hand surgery, prevention of DVT, Raynauds disease, arteriosclerolosis, gravitational oedema, lymphatic oedema, post-mastectomy oedema, after cast removal, flexion contractions.
- Client should be assessed by a qualified medical professional before using this product.

Features

- Ideal for home use, the Compress DL2002D Sequential Compression Kit includes a pump, all required sleeves plus tubes and connectors
- The Clinic model includes two full-length leg sleeves, an arm sleeve, plus all tubes and connectors
- The Compress DL2002D Sequential Compression Pump provides highly effective, non-invasive treatment using air compressed on to the limb to move fluids
- Gentle peristaltic action, massages the limb aiding the management of oedema
- Easy to operate pump with 2 controls for pressure level, and cycle-timing
- There are 3 modes of compression at the touch of a button. The first mode ('A') inflates and then deflates each of the 4 chambers, one at a time from foot to thigh. This mode is suitable for general muscle massage. The second mode ('B') inflates each chamber sequentially, foot to thigh, until all chambers are inflated, then deflates all 4 chambers. This mode increases circulation of lymph and blood. The third mode ('C') alternates between 'A' and 'B'

DVA: RAP# AR23 For more information please refer to pg 7.



Product	Code
Compress compression pump kit - complete	DL2002D
Leg replacement sleeve	DL - LEG
Arm replacement sleeve	DL - ARM



'Compress' Compression Pump/Armsleeve Kit

Features

- The Compress 2003V sequential compression pump and armsleeve set, represents excellent value, and is ideal for home use
- The armsleeve fits left and right, and consists of 4 chambers, with the pump inflating each chamber sequentially, wrist to axilla, until all chambers are inflated, then deflates all 4 chambers
- This pump is easy to operate, with 2 controls-one for the required pressure level, and the other for the timing of each treatment
- This lightweight pump (2kg) pump has a pressure range of 50-240mmHg, and a timer range up to 30 minutes

DVA: RAP# AR23 For more information please refer to pg 7.

Product	Code
Compress compression pump/armsleeve kit	DL2003V

C-Boot

Application



- The C-Boot treats a wide variety of vascular and lymphatic conditions
- The C-Boot is a unique device, requiring normal walking motion to apply dynamic sequential, intermittent compression to the leg
- The C-Boot 'elastic' model features an elastic foot-sleeve, which is easy to apply and comfortable to wear under clothing and 'sensible' shoes. This style is appropriate for those who are quite mobile
- The C-Boot 'classic' model features wrap-around Velcro fastening at the foot, and is more appropriate for those with significant swelling of the foot or tissue breakdown. The classic model is suitable for those who are not as mobile, and are perhaps using special open-type footwear
- Such devices must only to be used under the supervision of a qualified medical professional

Mechanics & Application of the C-Boot

- A small pressure pad is positioned within the heel of the garment, pumping air into chambers with every step
- As you walk, the three chambers inflate to the correct pressure level, one at a time, sequentially from bottom to top
- Once the third chamber is fully inflated, the C-Boot deflates, and the process starts again
- To apply, simply put the foot into the foot-sleeve, or in the case of the Classic, wrap the Velcro around the foot, then fasten the C-Boot around the leg, put on your shoes or appropriate footwear, and start walking

Optional Compressor

- A small optional compressor attachment is available for times when the patient is stationary
- This compressor can be either single port (for one C-Boot), or dual port (where garments are worn on both legs)
- Garments may be ordered individually, or as a Single Kit (1 x C-Boot + single port compressor), or Dual Kit (2 x C-Boot + dual port compressor)



DVA: RAP# AR23 For more information please refer to pg 7.

'Elastic'	Ankle	Calf	Shoe size	Product Codes	C-Boot	C-Boot K1 (Single Kit)	C-Boot K2 (Dual Kit)	
Sm/med	21 - 29	30 - 43	35 - 41	Elastic - Sm/med	CB - E3000 - M	CBKS - E3000-M	CBKD - E3000 - M	
Large A	29 - 33	33 - 48	35 - 41	Elastic - Large A	CB - E3000 - L - A	CBKS - E3000 - L - A	CBKD - E3000 - L - A	
Large B	29 - 33	33 - 48	42 - 48	Elastic - Large B	CB - E3000 - L - B	CBKS - E3000 - L - B	CBKD - E3000 - L - B	
Xlarge	33 - 44	36 - 60	42 - 48	Elastic - XLarge	CB - E3000 - XL	CBKS - E3000 - XL	CBKD - E3000 - XL	
'Classic'	Ankle	Calf	Shoe size	Product Codes	C-Boot	C-Boot K1 (Single Kit)	C-Boot K2 (Dual Kit)	
Sm/med	21 - 29	30 - 43	38 - 43	Classic - Sm/med	CB - C3000 - M	CBKS - C3000 - M	CBKD - C3000 - M	
Large	29 - 33	33 - 48	44 - 46	Classic - Large	CB - C3000 - L	CBKS - C3000 - L	CBKD - C3000 - L	
Xlarge	33 - 44	36 - 60	47 +	Classic - XLarge	CB - C3000 - XL	CBKS - C3000 - XL	CBKD - C3000 - XL	
C-Boot leggings - liners for use with C-Boot - pk 5							CBKD - C3000 - XL	CBOOT - L5
C-Boot leggings - liners for use with C-Boot - pk 10							CBKD - C3000 - XL	CBOOT - L10

Aidacare Online

For all of your product enquiries in one user-friendly site visit us online at www.aidacare.com.au

- New product releases - updated daily
- Clear and concise product descriptions and specifications
- Contract specific ordering information (DVA, TAC & MASS)
- Downloadable DVA RAP and other order forms
- Full colour product images
- Information on our range of service offerings
- Newsletter subscription page

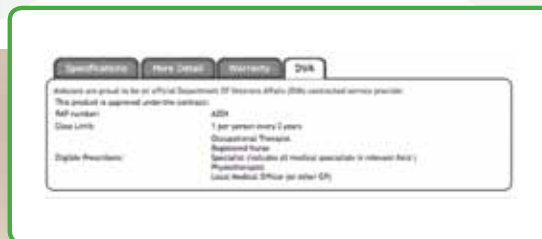

"We care for your care"



Ramps

P 211 Modular and Rubber Ramps

Custom Ramps - Home Modifications

(refer to page 10)



Silver Star Ramp

- Lightweight portable aluminium ramps that folds easily in half for convenient storage & transportation
- 24 months warranty

DVA For eligibility & prescriber info please refer to pg 7.

Code	Description	Width	Length	Max. Height	Product Weight	Max. User Weight	RAP #:
RAM656370	Silver Star Ramp 2 ft	750 mm	610 mm	180 mm	5 kg	272 kg	AL11
RAM656380	Silver Star Ramp 3 ft	750 mm	910 mm	250 mm	8 kg	272 kg	AL11
RAM656390	Silver Star Ramp 4 ft	750 mm	1220 mm	300 mm	11 kg	272 kg	AL11
RAM656400	Silver Star Ramp 5 ft	750 mm	1520 mm	330 mm	13 kg	272 kg	AL11
RAM656410	Silver Star Ramp 6 ft	750 mm	1830 mm	510 mm	16 kg	272 kg	AL11



Extendable Track Ramp

- The ramp is a 3 section telescoping ramp. It is made from a lightweight anodized aluminium construction. Storage length of only 750 mm
- 12 months warranty

DVA For eligibility & prescriber info please refer to pg 7.

Code	Description	Width	Length	Max. Height	Product Weight	Max. User Weight	RAP #:
RAM656010	Extendable Track Ramp	150 mm	1500 mm	330 mm	6 kg (set)	180 kg	AL11



Personal & Senior Ramps

- The Personal is a lightweight portable ramp, allows easy access in domestic situations including climbing curbs. Features a strap for storage on back of wheelchair and folds up to allow for storage and transportation
- The Senior is remarkably lightweight and strong and folds easy to assist in storage and transportation Available in a large range of sizes

DVA For eligibility & prescriber info please refer to pg 7.

Code	Description	Width	Length	Max. Height	Product Weight	Warranty	Max. User Weight	RAP #:
RAM656200	Personal Ramp	745 mm	700 mm	175 mm	4.7 kg	12 months	300 kg	AL11
RAM656210	Carry Bag to suit Ramp Personal							AL11
RAM656360	Senior Ramp 900	750 mm	900 mm	225 mm	4.8 kg	12 months	300 kg	AL11
RAM656310	Senior Ramp 1200	750 mm	1200 mm	300 mm	8.3 kg	12 months	300 kg	AL11
RAM656320	Senior Ramp 1350	750 mm	1350 mm	337 mm	8.5 kg	12 months	300 kg	AL11
RAM656330	Senior Ramp 1650	750 mm	1650 mm	412 mm	10.8 kg	12 months	300 kg	AL11
RAM656340	Senior Ramp 2000	750 mm	2000 mm	500 mm	11.7 kg	12 months	300 kg	AL11
RAM656350	Senior Ramp 3500	750 mm	3500 mm	875 mm	24.7 kg	12 months	300 kg	AL11



Multipurpose Ramp

- Assists mobility equipment users and carers to navigate steps and gaps
- Lightweight portable ramp with multiple uses
- Ideal for commercial and travel situations
- Folds up to allow for storage and transportation
- Strap for storage on back of wheelchair
- Ramp bag also available
- 12 months warranty

DVA For eligibility & prescriber info please refer to pg 7.

Code	Description	Width	Length	Max. Height	Product Weight	Max. User Weight	RAP #:
RAM656180	Multipurpose Ramp	835mm	870mm	220mm	5.6 kg	300 kg	AL11
RAM656190	Carry Bag to suit Ramp Multipurpose						AL11





EBL Ramp

- The E.B.L. (Edge Barrier Limiter) has the added security of edge barriers. It is particularly suited to providing instant access to buses, trains and buildings where a permanent ramp is impractical and folds easily for storage and transportation
- Available in a large range of sizes
- 12 months warranty

DVA For eligibility & prescriber info please refer to pg 7.

Code	Description	Width	Length	Max. Height	Product Weight	Max. User Weight	RAP #:
RAM656170	EBL Ramp 900	750 mm	900 mm	225 mm	6 kg	300 kg	AL11
RAM656090	EBL Ramp 1200	820 mm	1200 mm	300 mm	9.7 kg	300 kg	AL11
RAM656100	EBL Ramp 1350	820 mm	1350 mm	337 mm	11.1 kg	300 kg	AL11
RAM656110	EBL Ramp 1650	820 mm	1650 mm	412 mm	13 kg	300 kg	AL11
RAM656120	EBL Ramp 2000	820 mm	2000 mm	500 mm	13.7 kg	300 kg	AL11
RAM656130	EBL Ramp 2500	820 mm	2500 mm	625 mm	23 kg	300 kg	AL11
RAM656140	EBL Ramp 3000	820 mm	3000 mm	750 mm	27.3 kg	300 kg	AL11
RAM656150	EBL Ramp 3500	820 mm	3500 mm	875 mm	31.5 kg	300 kg	AL11



Suit Case Ramp

- A wide single folding aluminium ramp for scooter and wheelchair use
- Available in 2 sizes
- 12 month warranty
- Folds in half to be carried like a suitcase
- Slip resistant surface

DVA For eligibility & prescriber info please refer to pg 7.

Code	Description	Width	Length	Product Weight	Max. User Weight	RAP #
RAM656280	Suitcase Ramp 1219	381 mm	1219 mm	9 kg	363 kg	AL11
RAM656270	Suitcase Ramp 915	381 mm	914 mm	7.3 kg	363 kg	AL11



Threshold Ramp

- Assists mobility equipment users and carers to navigate steps and bumps
- Can be used as one or in combination to make entry and exit convenient and safe
- Durable modular ramp designed for doorways, sliding doors and raised landings
- Constructed with extruded, anodized aluminium that will not rust or corrode

DVA For eligibility & prescriber info please refer to pg 7.

Code	Description	Width	Length	Max. Height	Product Weight	Max. User Weight	RAP #:
RAM656420	Threshold Ramp 25	860 mm	165 mm	25 mm	2.2 kg	272 kg	AL11
RAM656430	Threshold Ramp 38	860 mm	241 mm	38 mm	2.5 kg	272 kg	AL11
RAM656440	Threshold Ramp 51	860 mm	304 mm	51 mm	3.6 kg	272 kg	AL11
RAM656450	Threshold Ramp 76	860 mm	431 mm	76 mm	5.0 kg	272 kg	AL11
RAM656460	Threshold Ramp 102	860 mm	565 mm	102 mm	6.8 kg	272 kg	AL11
RAM656470	Threshold Ramp 127	860 mm	698 mm	127 mm	8.6 kg	272 kg	AL11



Rubber Threshold Ramp

- Assists mobility equipment users and carers to navigate steps and bumps
- Made from recycled rubber, these lightweight threshold ramps are ideal for doorways
- 12 month warranty

DVA For eligibility & prescriber info please refer to pg 7.

Code	Description	Width	Length	Max. Height	Product Weight	Max. User Weight	RAP #:
RAM656211	Rubber Threshold Ramp Sm	200 mm	1010 mm	25 mm	4 kg	300 kg	AL11
RAM656212	Rubber Threshold Ramp Lg	400 mm	1140 mm	50 mm	13 kg	300 kg	AL11

REFER TO HOME MODIFICATIONS SECTIONS
ON PAGE 10 FOR CUSTOM BUILT RAMPS

Aidacare Online

For all of your product enquiries in one user-friendly site visit us online at www.aidacare.com.au

- New product releases - updated daily
- Clear and concise product descriptions and specifications
- Contract specific ordering information (DVA, TAC & MASS)
- Downloadable DVA RAP and other order forms
- Full colour product images
- Information on our range of service offerings
- Newsletter subscription page

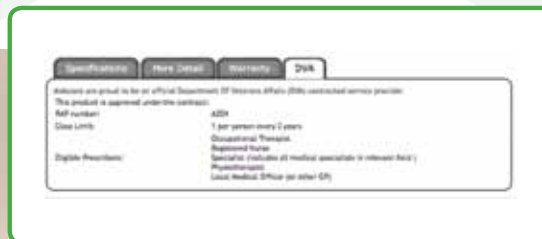

"We care for your care"



Therapy & Exercise



- P 215 Exercise & Resistance Training
- P 221 Physiotherapy - Other
- P 225 Enteral Feeding Pumps & Accessories
- P 228 Bracing & Supports - Neck & Shoulder
- P 232 Bracing & Supports - Rib & Abdomen
- P 233 Bracing & Supports - Back Support
- P 240 Bracing & Supports - Upper Limb - Arm & Elbow
- P 246 Bracing & Supports - Upper Limb - Wrist & Hand
- P 262 Bracing & Supports - Lower Limb - Knee
- P 274 Bracing & Supports - Lower Limb - Calf & Thigh
- P 276 Bracing & Supports - Lower Limb - Ankle
- P 282 Bracing & Supports - Lower Limb - Foot & Toe
- P 290 Bracing & Supports - Male Support



Exy Pedals

- Pedal system for exercise and therapy
- Encourages exercise for users who are not highly mobile
- Can be used for legs and arms
- Lightweight, allowing for easy transportation and storage
- No assembly required

✓ DVA CONTRACTED
 AV02 BUY (P.A Rqd)
 Prescribers... Phys/S/Ch/Ost/LMO
 For approval rules refer to pg 7.

Code	Description	Warranty	✓ RAP #:
FPP292800	Exy Pedals	12 months	AV02



Exercise Bike

- Attractive, reliable bike features on-demand exercise feedback
- Adjustable resistance levels, smooth magnetic resistance
- Easy to operate control panel with large LCD window
- Console feedback: Time, Speed, Distance, Calories, Scan

✓ DVA CONTRACTED
 AV01 HIRE (P.A Rqd)
 Prescribers... Phys/S/Ch/Ost/LMO
 For approval rules refer to pg 7.

Code	Description	Length	Width	Height	Warranty	Max. User Wt.	✓ RAP #:
FPP290610	Exercise Bike	920 mm	550 mm	1290 mm	12 months	100 kg	AV01



Exercise Putty

- Exercise putty designed to strengthen and rehabilitate hand & finger muscles
- Less oily than other traditional putty, non-toxic and bleed proof
- Leaves no colour or residue on the client's hands

✓ DVA CONTRACTED
 AV10 BUY
 Prescribers... Phys/S/OT/Ch/Ost/LMO
 For approval rules refer to pg 7.

Code	Description	Weight	Colour	Warranty	✓ RAP #:
FPP298100	Exercise Putty Super Soft	0.85 kg	Tan	6 months	AV10
FPP298200	Exercise Putty Soft	0.85 kg	Yellow	6 months	AV10
FPP298300	Exercise Putty Medium	0.85 kg	Red	6 months	AV10
FPP298400	Exercise Putty Medium Firm	0.85 kg	Green	6 months	AV10
FPP298500	Exercise Putty Firm	0.85 kg	Blue	6 months	AV10
FPP298600	Exercise Putty Extra Firm	0.85 kg	Grey	6 months	AV10



PVC Dipped Dumbbells

- Dumbbells used for strengthening and exercise or therapy
- Large range of weights available

Code	Description	Weight	Colour	Warranty
FPP290310	PVC Dipped Dumbbell	0.5 kg	Pink	12 months
FPP290320	PVC Dipped Dumbbell	1.0 kg	Purple	12 months
FPP290330	PVC Dipped Dumbbell	1.5 kg	Green	12 months
FPP290340	PVC Dipped Dumbbell	2.0 kg	Yellow	12 months
FPP290350	PVC Dipped Dumbbell	2.5 kg	Red	12 months
FPP290360	PVC Dipped Dumbbell	3.0 kg	Blue	12 months
FPP290370	PVC Dipped Dumbbell	4.0 kg	Grey	12 months
FPP290380	PVC Dipped Dumbbell	5.0 kg	Black	12 months



Theraband Soft Weights

- Hand-held, ball-shaped isotonic weights
- Provide more versatility for strength training and rehabilitation exercises

Code	Description	Weight	Colour
FPF290381	Theraband Soft Weight	0.5 kg	Tan
FPF290382	Theraband Soft Weight	1.0 kg	Yellow
FPF290383	Theraband Soft Weight	1.5 kg	Red
FPF290384	Theraband Soft Weight	2.0 kg	Green
FPF290385	Theraband Soft Weight	2.5 kg	Blue
FPF290386	Theraband Soft Weight	3.0 kg	Black



Handgrips

- Designed to provide resistance to hands for general strengthening and conditioning
- Sold as a pair

Code	Description	Weight	Warranty
FPF290440	Handgrips	Medium	12 months
FPF290450	Handgrips	Strong	12 months
FPF290460	Handgrips	Extra Strong	12 months



Soft Ankle/Wrist Weights

- Soft Ankle/Wrist Weights for strengthening ankles, legs and arms
- One size fits most

Code	Description	Weight	Colour	Warranty
FPF290480	Soft Ankle/Wrist Weight 0.5	0.5 kg	Grey	12 months
FPF290470	Soft Ankle/Wrist Weight 1	1.0 kg	Grey	12 months
FPF290490	Soft Ankle/Wrist Weight 1.5	1.5 kg	Grey	12 months
FPF290500	Soft Ankle/Wrist Weight 2	2.0 kg	Grey	12 months



Mini Hand Weights

- Soft dumbbell designed to fit on the hand during exercise
- Adjustable strap for secure fit
- Sold as a pair

Code	Description	Weight	Colour	Warranty
FPF290560	Mini Hand Weight	2 x 0.5 kg	Grey/Black	12 months
FPF290570	Mini Hand Weight	2 x 1.0 kg	Grey/Black	12 months



Theraband Retail Pack

- Theraband Retail Pack conveniently packaged for user requiring increased levels of resistance
- 3 bands of different resistance levels per pack

✓ DVA CONTRACTED
 AV10..... BUY
 Prescribers... Phys/S/OT/Ch/Ost/LMO
 For approval rules refer to pg 7.

Code	Description	Length	Width	Colour	Resistance	✓ RAP #:
FPP310900	Theraband Retail Pack Light	1.5m x 3	140 mm	Yellow, Red, Green	Low, Medium, Heavy	AV10
FPP311000	Theraband Retail Pack Heavy	1.5m x 3	140 mm	Green, Blue, Black	Heavy, Extra Heavy & Special Heavy	AV10



Theraband Dispenser Bands

- Theraband Dispenser system provides the ideal length for individual exercises
- Stretchable latex rubber in five colour-coded resistance in lengths of 152cm
- Available as individual packets or as a complete dispenser system

✓ DVA CONTRACTED
 AV10 BUY
 Prescribers... Phys/S/OT/Ch/Ost/LMO
 For approval rules refer to pg 7.

Code	Description	Length	Width	Colour	Resistance	✓ RAP #:
FPP308450	Theraband 152	152 cm	140 mm	Yellow	Low	AV10
FPP308451	Theraband 152	152 cm	140 mm	Red	Medium	AV10
FPP308452	Theraband 152	152 cm	140 mm	Green	Heavy	AV10
FPP308453	Theraband 152	152 cm	140 mm	Blue	Extra Heavy	AV10
FPP308454	Theraband 152	152 cm	140 mm	Black	Special Heavy	AV10



Theraband

- Theraband Exercise Bands for resistive exercise or therapy
- Colour-coded for progressive resistance strengths

✓ DVA CONTRACTED
 AV10 BUY
 Prescribers... Phys/S/OT/Ch/Ost/LMO
 For approval rules refer to pg 7.

Code	Description	Length	Width	Colour	Resistance	✓ RAP #:
FPP308500	Theraband	5.5 m	140 mm	Yellow	Low	AV10
FPP308600	Theraband	5.5 m	140 mm	Red	Medium	AV10
FPP308700	Theraband	5.5 m	140 mm	Green	Heavy	AV10
FPP308800	Theraband	5.5 m	140 mm	Blue	Extra Heavy	AV10
FPP308900	Theraband	5.5 m	140 mm	Black	Special Heavy	AV10
FPP310200	Theraband	5.5 m	140 mm	Silver	Super Heavy	AV10
FPP309000	Theraband	45.5 m	140 mm	Yellow	Low	AV10
FPP309100	Theraband	45.5 m	140 mm	Red	Medium	AV10
FPP309200	Theraband	45.5 m	140 mm	Green	Heavy	AV10
FPP309300	Theraband	45.5 m	140 mm	Blue	Extra Heavy	AV10
FPP309400	Theraband	45.5 m	140 mm	Black	Special Heavy	AV10
FPP309450	Theraband	45.5 m	140 mm	Silver	Super Heavy	AV10



Theraband Tubing Retail Pack

- Theraband Tubing Retail Pack conveniently packaged for user requiring increased levels of resistance.
- 3 tubes of different resistance levels per pack

Code	Description	Length	Width	Colour	Resistance
FPP311100	Theraband Tubing Retail Pack Light	1.83 m x 3	140 mm	Yellow, Red, Green	Low, Medium, Heavy
FPP311200	Theraband Tubing Retail Pack Heavy	1.83 m x 3	140 mm	Green, Blue, Black	Heavy, Extra Heavy, Special Heavy



Theraband Tubing

- Theraband Exercise Tubing is a natural rubber tubing available in 6 colour-coded levels of resistance
- Improves strength, range of motion and cooperation of muscle groups

✓ DVA CONTRACTED
 AV10..... BUY
 Prescribers... Phys/S/OT/Ch/Ost/LMO
 For approval rules refer to pg 7.

Code	Description	Length	Colour	Resistance	✓ RAP #:
FPP310400	Theraband Tubing	7.5	Yellow	Low	AV10
FPP310500	Theraband Tubing	7.5	Red	Medium	AV10
FPP310600	Theraband Tubing	7.5	Green	Heavy	AV10
FPP310700	Theraband Tubing	7.5	Blue	Extra Heavy	AV10
FPP310800	Theraband Tubing	7.5	Black	Special Heavy	AV10
FPP310850	Theraband Tubing	7.5	Silver	Super Heavy	AV10
FPP309900	Theraband Tubing	30	Yellow	Low	AV10
FPP309800	Theraband Tubing	30	Red	Medium	AV10
FPP309700	Theraband Tubing	30	Green	Heavy	AV10
FPP309600	Theraband Tubing	30	Blue	Extra Heavy	AV10
FPP309500	Theraband Tubing	30	Black	Special Heavy	AV10
FPP309450	Theraband Tubing	30	Silver	Super Heavy	-



Theraband Tubing with Handles

- Theraband Resistance Tubing with Handles for convenient, ready-to-use clinical or home solutions
- Available in 6 Theraband colors and resistances

✓ DVA CONTRACTED
 AV10..... BUY
 Prescribers... Phys/S/OT/Ch/Ost/LMO
 For approval rules refer to pg 7.

Code	Description	Length	Colour	Resistance	✓ RAP #:
FPP309910	Theraband Tubing with Handle	121 cm	Yellow	Low	AV10
FPP309911	Theraband Tubing with Handle	121 cm	Red	Medium	AV10
FPP309912	Theraband Tubing with Handle	121 cm	Green	Heavy	AV10
FPP309913	Theraband Tubing with Handle	121 cm	Blue	Extra Heavy	AV10
FPP309914	Theraband Tubing with Handle	121 cm	Black	Special Heavy	AV10
FPP309915	Theraband Tubing with Handle	121 cm	Silver	Super Heavy	AV10



Theraband Tubing with Padded Cuffs

- Resistance Tubing with padded cuffs for convenient, ready-to-use clinical or home solutions
- Sturdy design with comfortable, no-slip cuffs
- Ideal for sports performance enhancement and advanced injury rehabilitation

✓ DVA CONTRACTED
 AV10..... BUY
 Prescribers... Phys/S/OT/Ch/Ost/LMO
 For approval rules refer to pg 7.

Code	Description	Colour	Resistance	✓ RAP #:
FPP309920	Theraband Tubing with Padded Cuffs	Red	Beginner/Intermediate	AV10
FPP309921	Theraband Tubing with Padded Cuffs	Green	Intermediate	AV10
FPP309922	Theraband Tubing with Padded Cuffs	Blue	Intermediate/Advanced	AV10
FPP309923	Theraband Tubing with Padded Cuffs	Black	Advanced	AV10



Theraband Assist Strap

- Theraband Assist Strap is an attachment designed to increase exercises with bands or tubing
- Assists users with weakened grip to use bands and tubing

✓ DVA CONTRACTED
 AV10 BUY
 Prescribers... Phys/S/OT/Ch/Ost/LMO
For approval rules refer to pg 7.

Code	Description	RAP #:
FPP310010	Theraband Assist Strap	AV10



Theraband Sports Handle

- Extra long Theraband Sports Handle allows for two hands to grasp it easily
- Designed for use with bands and/or tubing
- Attaches easily to bands or tubing to provide ideal grip for exercising

✓ DVA CONTRACTED
 AV10 BUY
 Prescribers... Phys/S/OT/Ch/Ost/LMO
For approval rules refer to pg 7.

Code	Description	RAP #:
FPP310020	Theraband Sports Handle	AV10



Theraband FlexBar

- Theraband FlexBar is a flexible, durable resistance device
- Ridged surface for enhanced grip
- Research-proven effective for Tennis Elbow
- Used to improve grip strength and upper extremity stabilisation

✓ DVA CONTRACTED
 AV10 BUY
 Prescribers... Phys/S/OT/Ch/Ost/LMO
For approval rules refer to pg 7.

Code	Description	Colour	Resistance	RAP #:
FPP311205	Theraband FlexBar	Yellow	Light	AV10
FPP311210	Theraband FlexBar	Red	Light	AV10
FPP311220	Theraband FlexBar	Green	Medium	AV10
FPP311230	Theraband FlexBar	Blue	Heavy	AV10

Therapy & Exercise

**FOR COMPRESSION & PROTECTION
GARMENTS REFER TO PAGE 170**





Theraband Hand Trainer

- Theraband Progressive Hand Trainer assists patients recovering from hand or wrist surgery
- Helps improve hand, finger and thumb strength and mobility during hand rehabilitation
- Colour-coded for progressive resistance exercises
- Intro Kit contains instruction guide to demonstrate proper exercises

✓ DVA CONTRACTED
 AV10 BUY
 Prescribers... Phys/S/OT/Ch/Ost/LMO
For approval rules refer to pg 7.

Code	Description	✓ RAP #:
FPP311250	Theraband Hand Trainer, Intro Kit	AV10



Theraband Shoulder Pulley

- Theraband Shoulder Pulley is designed to assist patients undergoing shoulder rehab
- Features a unique rope divided into sections for immediate feedback on progress

✓ DVA CONTRACTED
 AV10 BUY
 Prescribers... Phys/S/OT/Ch/Ost/LMO
For approval rules refer to pg 7.

Code	Description	✓ RAP #:
FPP311260	Theraband Shoulder Pulley	AV10



Theraband Stability Trainer

- Supplied in three densities to provide a progressive system of balance training
- Anti-slip ridged surface and oval foot fitting shape
- Made of durable PVC

✓ DVA CONTRACTED
 AV10 BUY
 Prescribers... Phys/S/OT/Ch/Ost/LMO
For approval rules refer to pg 7.

Code	Description	Colour	Resistance	✓ RAP #:
FPP311280	Theraband Stability Trainer	Blue	Soft	AV10
FPP311281	Theraband Stability Trainer	Green	Firm	AV10
FPP311282	Theraband Stability Trainer	Black	X-Soft	AV10

REFER TO PAGE 14 FOR FURTHER
 INFORMATION REGARDING
 AIDACARE EQUIPMENT RENTAL



Therapy & Exercise



TENS Unit

- Electro stimulation pack assists with therapy and pain relief
- Designed to assist with light to moderate pain relief
- Supplied with 9 volt battery, leads and 1 packet of electrodes
- Can be used by professionals or in the home

✓ DVA CONTRACTED

BD03..... BUY
Prescribers... Phys/PC/Ch/Ost/S/LMO

BD04..... BUY
Prescribers... Phys/PC/Ch/Ost/RN/S/LMO

For approval rules refer to pg 17.

Code	Description	Warranty	✓ RAP #:
FPP315200	TENS Unit	12 months	BD03
GSP342245	Replacement Electrodes (Pkt 4)		BD04
GSP342240	Charger		BD04
GSP342230	Batteries		BD04



Premium Rigid Strapping Tape

- Provides maximum support and protection against injury during sport
- Assists in recovery from injury
- Extra strong adhesive with pinked edge

✓ DVA CONTRACTED

AV10..... BUY
Prescribers... Phys/S/OT/Ch/Ost/LMO

For approval rules refer to pg 17.

Code	Description	Colour	Resistance	✓ RAP #:
GMS337057	Premium Rigid Strapping Tape	38 mm	13.7 m	AV10



Elastic Strap (Multi Purpose)

- Multi purpose elastic strap attaches to itself in any position
- Can be fitted anywhere on the body
- Ideal for binding knees, thighs and the abdomen
- Designed to stabilise and assist healing of injured soft tissue
- One size fits most

✓ DVA CONTRACTED

AR01..... BUY
Prescribers... Phys/Pod/S/Ch/Ost/O/P/LMO

For approval rules refer to pg 17.

Code	Description	Length	Colour	Warranty	✓ RAP #:
FBS283560	Elastic Strap	Black	1 metre	12 months	AR01
FBS280490	Elastic Strap	Beige	1 metre	12 months	AR01
FBS280495	Elastic Strap	White	1 metre	12 months	AR01



Elastic Strap with Loop

- Multi purpose elastic strap with a loop sewn at one end for effective wrapping
- Ideal for wrists, arms, ankles, calves and forearms
- Designed to stabilise and assist healing of injured soft tissue
- One size fits most

✓ DVA CONTRACTED

AR01..... BUY
Prescribers... Phys/Pod/S/Ch/Ost/O/P/LMO

For approval rules refer to pg 17.

Code	Description	Length	Colour	Warranty	✓ RAP #:
FBS283540	Elastic Strap with Loop	Black	700 mm	12 months	AR01
FBS283550	Elastic Strap with Loop	Beige	700 mm	12 months	AR01
FBS283555	Elastic Strap with Loop	White	700 mm	12 months	AR01



Micro Professional Heat Pack

- Micro professional range ideal for use in institutions
- Meets all the necessary health and safety requirements

Code	Description
FPP292140	Micro Professional Heat Pack Standard - 300x300mm
FPP292150	Micro Professional Heat Pack - Neck



Lupin Hot/Cold Pack Back

- Easily moulds to the contour of the lower back
- Adjustable belt
- Hands free relief without interrupting daily commitments
- One size fits all
- Can be used Hot or Cold
- Fabric is 100% natural cotton corduroy
- "Low allergy" alternative to wheat and are more resistant to moisture (to make cleaning easier) and less weight for more comfort

Code	Description	Warranty
FPP292151	Lupin Hot/Cold Pack Back	12 months



Lupin Hot/Cold Pack Body Pillow

- Forms to your body shape and is suitable for all parts of the body
- Can be used Hot or Cold
- Fabric is 100% natural cotton corduroy
- "Low allergy" alternative to wheat and are more resistant to moisture (to make cleaning easier) and less weight for more comfort

Code	Description	Width	Length	Warranty
FPP292152	Lupin Hot/Cold Pack Body Pillow	400mm	190 mm	12 months



Lupin Hot/Cold Pack Square

- Forms to your body shape and is suitable for all parts of the body
- Can be used Hot or Cold
- Fabric is 100% natural cotton corduroy
- "Low allergy" alternative to wheat and are more resistant to moisture (to make cleaning easier) and less weight for more comfort

Code	Description	Width	Length	Warranty
FPP292153	Lupin Hot/Cold Pack Square	200 mm	200 mm	12 months



Lupin Hot/Cold Pack Rectangle

- Forms to your body shape and is suitable for all parts of the body
- Can be used Hot or Cold
- Fabric is 100% natural cotton corduroy
- "Low allergy" alternative to wheat and are more resistant to moisture (to make cleaning easier) and less weight for more comfort

Code	Description	Width	Length	Warranty
FPP292154	Lupin Hot/Cold Pack Rectangle	330 mm	130 mm	12 months



Lupin Hot/Cold Pack Shoulder Wrap

- Will assist to soothe neck and shoulder pain, muscular stress and mastitis
- Can be used Hot or Cold
- Fabric is 100% natural cotton corduroy
- “Low allergy” alternative to wheat and are more resistant to moisture (to make cleaning easier) and less weight for more comfort

Code	Description	Warranty
FPP292155	Lupin Hot/Cold Pack Shoulder Wrap	12 months



Lupin Hot/Cold Pack Hand Glove

- Unique hot or cold mitt
- Easy to use and an excellent treatment for arthritis, rheumatism and general circulation
- Low allergy alternative to wheat

Code	Description	Warranty
FPP292156	Lupin Hot/Cold Pack Hand Glove	12 months



Fitness Ball

- Inflatable fitness and therapy balls provide
- Widely used for physiotherapy and perceptual motor training
- Rated to 300 kg
- Seamless construction with anti-burst to withstand rugged use
- Available in assorted colours

Code	Description	Size	User height	Warranty	Max. User Weight
FPP303000	Fitness Ball 45cm	45cm	<150 cm	12 months	300 kg
FPP303300	Fitness Ball 55cm	55cm	150 -160 cm	12 months	300 kg
FPP303500	Fitness Ball 65cm	65cm	160 -180 cm	12 months	300 kg
FPP303600	Fitness Ball 75cm	75cm	180 -196 cm	12 months	300 kg
FPP303700	Fitness Ball 85cm	85cm	195 cm>	12 months	300 kg
FPP303800	Fitness Ball 100cm	100cm	N/A	12 months	300 kg



Stress Ball

- Designed for temporary relief of stress or as a rehabilitation tool for fine motor skills
- Specifically exercises the hand, wrist and forearm

Code	Description	Diameter	Warranty
FPP312400	Stress Ball	65 mm	6 months



Balance Wobble Board

- Balance board for therapy or exercise
- Designed for rehabilitation and strengthening of ankles
- Surface grooves for grip and stability
- Highly durable, strong and hard wearing

Code	Description	Warranty	Max. User Weight
FPP304000	Balance Wobble Board	12 months	500 kg

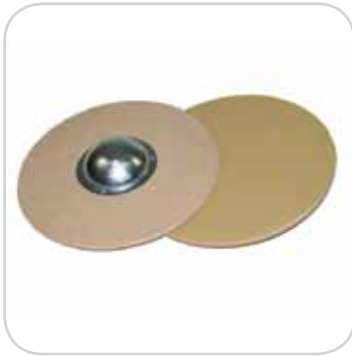

Wobble Board

- Timber balance board for therapy or exercise
- Designed for rehabilitation and strengthening of ankles
- Highly durable, strong and hard wearing

Code	Description	Warranty
FPP292700	Wobble Board	12 months



Stability Disc

- Stability disc has the benefits of both the fitness ball and the sitting wedge
- Can be used on any type of chair or stool
- Promotes upright posture and improves balance
- Conveniently portable

Code	Description	Diameter	Warranty
FPP305000	Stability Disc	330 mm	12 months



Freestanding Parallel Bars

- Freestanding Parallel Bars used for mobility training and therapy
- Widely used in therapy centres
- Adjustable legs for easy set-up
- Foldable for easy storage
- 36 month warranty

Code	Model	Width	Length	Height	Max. User Weight	Supplier Code
FPP307600	Freestanding Parallel Bars	650 mm	2500 mm	1065 - 640 mm	130 kg	KH990



Wall & Floor Mounted Parallel Bars

- Parallel Bars used for mobility training and therapy
- Widely used in therapy centres
- Bars can be conveniently mounted against a wall
- Height adjustable rails
- 36 month warranty

Code	Model	Width	Length	Rail Height	Max. User Weight	Supplier Code
FPP307700	Wall & Floor Mounted Parallel Bars	710 mm	2140 mm	710 - 1070 mm	130 kg	KH990SP

FOR OUR FULL RANGE OF
WALKING FRAMES & MOBILITY AIDS
REFER TO PAGE 294



Therapy & Exercise



Enteral Feeding Pumps

DVA For eligibility & prescriber info please refer to pg 7.

Code	Description	Unit	Manufacturer	RAP #:
52034.001	Enteral Feeding Pump - Patrol	1	Abbott	AS14
M771.001	Enteral Feeding Pump - Companion Clearstar	1	Abbott	AS14
9517455	Enteral Feeding Pump - Compat Enteral	1	Nestle	AS14
35679	Enteral Feeding Pump - Flocare Infinity	1	Nutricia	AS14
482400S	Enteral Feeding Pump - Kangaroo E-Pump	1	Tyco Healthcare	AS14
492457	Enteral Feeding Pump - Kangaroo 924	1	Tyco Healthcare	AS14

Enteral Feeding Pump Consumables

DVA For eligibility & prescriber info please refer to pg 7.

Code	Description	Comments	Unit	Manufacturer	RAP #:
0086.B01	Companion Clearstar Pump Set - Feeding Line Only	Single use only	30	Abbott	AS15
0504.001	Companion Ambulatory Carry Bag		1	Abbott	AS15
0507.B01	Companion Ambulatory Bag Set - Feeding Line Only - 500ml	Single use only	30	Abbott	AS15
G922.B01	Companion Pump Set - Uni Adap	Single use only	30	Abbott	AS15
0835.001	Flexiflo Y-Port Connector - 14/16FR		1	Abbott	AS15
0836.001	Flexiflo Y-Port Connector - 18/20FR		1	Abbott	AS15
F533.B01	Flexiflo Gravity Feeding Set - Feeding Line Only	Single use only	30	Abbott	AS15
M188.001	Flexiflo Gastrostomy Tube - 16FR		1	Abbott	AS15
M190.001	Flexiflo Gastrostomy Tube - 20FR		1	Abbott	AS15
0473.00101	Flexiflo Naso -Gastric Tube - 8FR		1	Abbott	AS15
0474.00101	Flexiflo Naso -Gastric Tube - 12FR		1	Abbott	AS15
M222.B01	Patrol Pump Set - Uni Adaptor	Single use only	30	Abbott	AS15
M433.001	Patrol Screw Cap Pump Set - Feeding Line Only	Single use only	30	Abbott	AS15
M241.B01	Flexitainer Bottle - 500ml	Single use only	30	Abbott	AS15
M240.B01	Flexitainer Bottle - 1000ml	Single use only	30	Abbott	AS15
000259	Bolus Feeding Tube - 24FR		1	Bard	AS15
000333	Dual Port Feeding Adaptor	Single use only	1	Bard	AS15
000631	Baloon Replacement Tube - 20FR		1	Bard	AS15
1366272	Luer Lock Syringes - 50/60ml	Single use only	30	Bard	AS15
300613	Eccentric Luer Slip Syringes - 20ml	Single use only	30	Bard	AS15
3100	Eccentric Luer Slip Syringe - 50/60ml	Single use only	30	Bard	AS15
3135	Eccentric Luer Lock Syringe - 20ml	Single use only	30	Bard	AS15
0105-06	Extension Tubing		1	Kimberely Clark	AS15
0112-18	Replacement Gastrostomy Tube - 18FR		1	Kimberely Clark	AS15
0136-20	Replacement Feeding Adaptors		1	Kimberely Clark	AS15
083104	Compat Naso-Gastric Feeding Tube - 8FR		1	Nestle	AS15
9517453	Compat E/F Adaptor - 18-22FR		1	Nestle	AS15
9517466	Compat Naso-Gastric Feeding Tube - Kit - 9-18FR		1	Nestle	AS15
9517470	Compat Naso-Gastric Feeding Tube - 8FR		1	Nestle	AS15
9517471	Compat Naso-Gastric Feeding Tube - 12FR		1	Nestle	AS15
9517472	Compat Naso-Gastric Feeding Tube - 10FR		1	Nestle	AS15
9517476	Compat Replacement Gastrostomy Tube - 18FR		1	Nestle	AS15
9517477	Compat Replacement Gastrostomy Tube - 20FR		1	Nestle	AS15
9517478	Compat Replacement Gastrostomy Tube - 22FR		1	Nestle	AS15
9517479	Compat Replacement Gastrostomy Tube - 24FR		1	Nestle	AS15
9519810	Compat Combiset - Vinyl Bags + Feeding Line - 1000ml	Single use only	30	Nestle	AS15
9521433	Compat Flexibag Spike Sets - Feeding Line Only	Single use only	30	Nestle	AS15



Enteral Feeding Pump Consumables (Cont.)

DVA For eligibility & prescriber info please refer to pg 7.

Code	Description	Comments	Unit	Manufacturer	RAP #:
35158	Flocare Infinity Pack Sets - For Pack Feed	Single use only	30	Nutricia	AS15
35159	Flocare Infinity Universal Set - For Bottles	Single use only	30	Nutricia	AS15
35165	Flocare Infinity Mobile Pack Set - For Pack Feed	Single use only	30	Nutricia	AS15
35176	Flocare Infinity pack Set (no port)	Single use only	30	Nutricia	AS15
35175	Flocare Infinity Universal Set (no port)	Single use only	30	Nutricia	AS15
35178	Flocare Infinity pack Mobile set (no port)	Single use only	30	Nutricia	AS15
35161	Flocare Infinity Universal Pack Set	Single use only	30	Nutricia	AS15
35732	Flocare Pack Reservoir	Single use only	30	Nutricia	AS15
35150	Flocare Universal Gravity Set	Single use only	30	Nutricia	AS15
35151	Flocare 800 Universal Set	Single use only	30	Nutricia	AS15
35147	Flocare 800 Pack Set	Single use only	30	Nutricia	AS15
35146	Flocare Gravity Feeding Set	Single use only	30	Nutricia	AS15
35746	Flocare Container - 500ml	Single use only	10	Nutricia	AS15
35724	Flocare Container - 1000ml	Single use only	10	Nutricia	AS15
3523	Flocare G-Tube - CH10		1	Nutricia	AS15
3524	Flocare G-Tube - CH14		1	Nutricia	AS15
3525	Flocare G-Tube - CH18		1	Nutricia	AS15
35426	Flocare G-Tube - CH20		1	Nutricia	AS15
35218	Flocare PUR MP TUBE - CH 5 50cm		1	Nutricia	AS15
35224	Flocare PUR MP TUBE - CH8 110cm		1	Nutricia	AS15
35225	Flocare PUR MP TUBE - CH8 130cm		1	Nutricia	AS15
35227	Flocare PUR MP TUBE - CH10 130cm		1	Nutricia	AS15
300867	Syringe Catheter Tip - 50ml	Single use only	30	Nutricia	AS15
SS10ES	Syringe Luer Lock - 10ml		30	Nutricia	AS15
19067TE	Syringe Luer Lock - 50ml	Single use only	30	Nutricia	AS15
SS10ES	Syringe Luer Eccentric - 10ml	Single use only	30	Nutricia	AS15
35718	Feeding Connector - Ch10		1	Nutricia	AS15
35717	Feeding Connector - Ch18		1	Nutricia	AS15
35754	Spikeable Adaptor	Single use only	30	Nutricia	AS15
35744	Bolus Adaptor		1	Nutricia	AS15
3640	Bottle Hangers		1	Nutricia	AS15
35719	Flocare 800 Dripstand		1	Nutricia	AS15
INF001	Infinity Dripstand		1	Nutricia	AS15
INF002	Backpack - Large		1	Nutricia	AS15
INF003	Backpack - Small		1	Nutricia	AS15
1814-715205	Rigid Container - Sterile - 1200ml	Single use only	36	Tyco Healthcare	AS15
1814-715210	Kangaroo Screw Cap Pump Set	Single use only	30	Tyco Healthcare	AS15
1814-717340	Kangaroo Universal Spike Set	Single use only	36	Tyco Healthcare	AS15
1814-717987	Kangaroo 3 in 1 Adaptor	Single use only	36	Tyco Healthcare	AS15
673622	924 Bag Set - DEHP Free - 1000ml	Single use only	30	Tyco Healthcare	AS15
673656	E-Pump EZ Cap - 1000ml	Single use only	30	Tyco Healthcare	AS15
673662	E-Pump Feed & Flush Set - 1000ml	Single use only	30	Tyco Healthcare	AS15
674655	E-Pump Proximal Spike Set	Single use only	30	Tyco Healthcare	AS15
674669	E-Pump Proximal Spike - Feed & Flush Set - 1000ml	Single use only	30	Tyco Healthcare	AS15



Enteral Feeding Pump Consumables (Cont.)

DVA For eligibility & prescriber info please refer to pg 7.

Code	Description	Comments	Unit	Manufacturer	RAP #:
716170	Nutriport Gastrostomy Kit 1.7cm - 16FR		1	Tyco Healthcare	AS15
718170	Nutriport Gastrostomy Kit 1.7cm - 18FR		1	Tyco Healthcare	AS15
720230	Nutriport Gastrostomy Kit 2.3cm - 20FR		1	Tyco Healthcare	AS15
762055	Kangaroo Joey Pump Set - 500ml	Single use only	30	Tyco Healthcare	AS15
770000	Kangaroo E-Pump Back Pack		1	Tyco Healthcare	AS15
770022	Kangaroo E-Pump Joey Back Pack	Single use only	1	Tyco Healthcare	AS15
777007	E-Pump Universal Spike Set	Single use only	30	Tyco Healthcare	AS15
777100	924 Sterile Bag - 1000ml	Single use only	30	Tyco Healthcare	AS15
778005	Universal Spike - Feed & Flush Set - 1000ml	Single use only	30	Tyco Healthcare	AS15
778104	E-Pump Feed & Flush Set - Sterile - 1000ml	Single use only	30	Tyco Healthcare	AS15
8884-702005	Kangaroo Bag & Set - EZ cap - 500ml	Single use only	30	Tyco Healthcare	AS15
8884-702500	Kangaroo Bag Gravity Set - 1000ml	Single use only	30	Tyco Healthcare	AS15
8884-703904	Feed Bag - EZ Cap Spike Port	Single use only	30	Tyco Healthcare	AS15
8884-704506	Kangaroo Spike Pump Set	Single use only	30	Tyco Healthcare	AS15
1814-715200	Kangaroo Rigid Container - 600ml	Single use only	30	Tyco Healthcare	AS15
8884-720205	Kangaroo Gastrostomy Tube - 20FR		1	Tyco Healthcare	AS15
8884-720221	Kangaroo Gastrostomy Tube - 22FR		1	Tyco Healthcare	AS15
8884-741813	Kangaroo Bolus Extension Set - Non Sterile	Single use only	10	Tyco Healthcare	AS15
8884-741821	Continous Feeding Set - Non Sterile	Single use only	10	Tyco Healthcare	AS15
8884-742050	Entristar Gastrostomy Kit - 3.5cm - 20FR		1	Tyco Healthcare	AS15
8884-773006	Kangaroo Bag + Admin EZ Cap - 1000ml	Single use only	30	Tyco Healthcare	AS15



Kangaroo E-Pump



Flocare Inifity



Cosmac Soff Foam Collar

- Washable polyurethane foam covered with stockinette
- Velcro fastening
- Sizing: first, measure depth (cm) from chin to clavicle for size, and then neck circumference for length
- Order by size (eg. Small/Regular, Large/Long etc)

DVA: RAP# AR18 (all codes) For more information please refer to pg 7.

Code	Size	Depth (cm)	Fit Neck Circum. (cm)
AF007	Small	7.5	28 - 35
AF011	Small/Long	7.5	35 - 43
AF008	Medium	8.0	28 - 35
AF012	Medium/Long	8.0	35 - 43
AF009	Large	10.0	35 - 43
AF014	XLarge	11.0	38 - 46



Philadelphia Collar

- Anterior piece cradles mandible to enhance rotation control
- Made of light, strong foam, easy to trim
- Bilateral velcro fastening
- Sizing: measure depth (cm) from chin to clavicle (A, B, C, or D), and neck circumference (S, M or L)
- Order by size (eg. Small A, medium B etc)

DVA: RAP# AR18 (all codes) For more information please refer to pg 7.

Depth	Neck Circumference (cm)			
	(cm)	Code - Small (25 - 30)	Code - Medium (33 - 40)	Code - Large (40 - 46)
A	6	OTC6141 AS	OTC6141 AM	OTC6141 AL
B	8	OTC6141 BS	OTC6141 BM	OTC6141 BL
C	11	OTC6141 CS	OTC6141 CM	OTC6141 CL
D	13	OTC6141 DS	OTC6141 DM	OTC6141 DL

Note: Order by neck size and depth (e.g. Small/A, Medium/B etc).



Exo 101 Firm Collar

- Designed for symptomatic relief of neck pain or injury
- Made of polyethylene plastic, with vinyl-covered foam padding
- Height adjustable from 12.5 to 14.5cm
- Air holes for ventilation and hook-and-loop closure
- Incorporates a hinge in the bottom perimeter and bias slots under the back portion of the head

DVA: RAP# AR18 (all codes) For more information please refer to pg 7.

Code	Size	Fit Neck Circum. (cm)
AF101S	Small	31 - 37
AF101M	Medium	35 - 41
AF101L	Large	40 - 45

Note: Measure around the circumference of the neck.

- Automatically widens when it is lowered under the chin, and narrows when raised
- Also available with a padded chin piece for positive positioning



Oppo 4090 Rigid Adj Collar

- Semi-rigid support for use with soft tissue damage, osteoarthritis and whiplash injuries
- Completely height-adjustable to provide flexion or extension positioning
- Vinyl-covered foam padding for patients comfort and easy cleaning

DVA: RAP# AR18 (all codes) For more information please refer to pg 7.

Code	Size	Fit Neck Circum. (cm)
OPP4090S	Small	34.3 - 40
OPP4090M	Medium	40 - 46.4
OPP4090L	Large	46.4 - 52.7
OPP4090XL	XLarge	52.7 - 59.1

Note: Measure around the circumference of the neck.



Oppo 4190 Rigid Adj Collar w/ chin

- Completely height-adjustable to provide desired flexion or extension positioning
- Vinyl-covered foam padding for patient's comfort and easy cleaning
- Ventilated to allow air circulation
- Hook and loop closure for quick, easy application and removal

DVA: RAP# AR18 (all codes) For more information please refer to pg 7.

Code	Size	Fit Neck Circum. (cm)
OPP4190S	Small	34.3 - 40
OPP4190M	Medium	40 - 46.4
OPP4190L	Large	46.4 - 52.7

Note: Measure around the circumference of the neck.



Aspen Collar - Adult

- Designed to optimize support and comfort, the key components for better patient outcomes
- All contact surfaces of the collar are cushioned with cotton-lined, breathable foam padding
- Provides substantial motion restriction without producing painful pressure points that can lead to skin breakdown or poor patient compliance

DVA: RAP# AR18 For more information please refer to pg 7.

Collar (1 set of pads)	Collar Set (2 sets of pads)	Replacement pads code	Size	Top of shoulders to chin (cm)	Neck Circum. (cm)	RAP #:
AS983108	AS983128	AS983159	Adult short	2	33 - 53	-
AS983110	AS983130	AS983159	Adult Regular	2 - 3	33 - 53	AR18
AS983112	AS983132	AS983159	Adult Tall	3 - 5	33 - 53	-
AS983114	AS983134	AS983159	Adult X/Tall	5+	33 - 53	-



Miami-J Collar - Adult

- A phenotype-driven sizing system - with unique fronts and backs that are bioengineered to work together for superior immobilisation - makes size selection simple, while drastically reducing the margin of error in fitting a patient
- Adjustable mandibular and occipital support enables customization to disburse pressure and avoid skin breakdown
- Sorbatex™ pads that are specifically engineered to be anti-decubitus - protecting skin integrity during extended wear - and are removable for easy cleaning
- Sternal pad disburse pressure and is removable for comfort and improved compliance when supine and/or swallowing
- Patient assist strap allows for flexibility and comfort without sacrificing immobilisation

DVA: RAP# AR18 (all codes) For more information please refer to pg 7.

Collar (1 set of pads)	Collar Set (2 sets of pads)	Replacement pads code	Size	Sizing Guidelines
MJ-300	MJR-300	MJP-100	Small	<ul style="list-style-type: none"> • standard for mature men • short-necked women
MJ-400	MJR-400	MJP-100	Medium	<ul style="list-style-type: none"> • standard for mature women • thin, mature men
MJ-500	MJR-500	MJP-100	Large	<ul style="list-style-type: none"> • long tall neck • 'swan' neck • young women • adolescents
MJ-200L	MJR-200L	MJP-200L	Stout	<ul style="list-style-type: none"> • very large neck circumference • obese • 'no neck' • massive shoulders
MJ-200S	MJR-200S	MJP-100	Super, Short	<ul style="list-style-type: none"> • kyphotic (chin-on-chest) neck • geriatric • osteoporitic and/or ankylosing spondylitic
MJ-250	MJR-250	MJP-250	XSmall	<ul style="list-style-type: none"> • very short, thin neck principally female • more prevalent in Asian population • rare

Standard Sizes:
> 70% of Population

Specialty Sizes:
< 30% of Population



Body Assist N71 Thermal Shoulder Brace

- Provides soft tissue support & compression
- Increases elasticity of muscles, ligaments & tendons
- Assists in prevention of injury or re-injury
- Elastic support strap fits comfortably under the arm pit & assists to generate better than average compression & support to the shoulder
- Multi-directional compression assists to reduce soft tissue swelling
- Can be worn while playing sports
- Promotes greater blood circulation, provides a more speedy recovery
- Contoured panels fit most body shapes
- Completely washable & hygienic
- Stabiliser strap is optional

DVA: RAP# AR03 (all codes) For more information please refer to pg 7.

Code - Stabiliser Strap	Size	To fit	(cm)	Code - Shoulder Brace - Left	Code - Shoulder Brace - Right	Size	(cm)
NHN71AC1	Regular	To fit N71B brace XS to M	80 - 90	NHN71 BL0	NHN71 BR0	XS	80 - 90
NHN71AC3	Large	To fit N71B brace M to XL	90 - 100	NHN71 BL1	NHN71 BR1	S	90 - 100
				NHN71 BL2	NHN71 BR2	M	100 - 110
				NHN71 BL3	NHN71 BR3	L	110 - 120
				NHN71 BL4	NHN71 BR4	XL	120 - 130

Note: Measure circumference around chest, around outside of arm on affected side (refer illustration).





Rehband 7126 Shoulder Support

- Soft and flexible shoulder support with excellent fit
- Provides warmth and pain relief to the shoulder joint

✓ DVA: RAP# AR03 (all codes) For more information please refer to pg 7.

Code - Left	Code - Right	Size	(cm)
REH7126 XS-L	REH7126 XS-R	XS	24 - 28
REH7126 S-L	REH7126 S-R	S	28 - 32
REH7126 M-L	REH7126 M-R	M	32 - 35
REH7126 L-L	REH7126 L-R	L	35 - 38
REH7126 XL-L	REH7126 XL-R	XL	38 - 42

Note: Measure biceps circ (cm).



Oppo 1072 Shoulder Support

- Provides compression and support to shoulder and aids healing
- Therapeutic warmth for the shoulder and upper arm
- Offers support and protection
- Minimizes potential for future injuries
- Fits left or right

✓ DVA: RAP# AR03 (all codes) For more information please refer to pg 7.

Code	Size	(cm)
OPP1072 S	S	83.2 - 93.3
OPP1072 M	M	93.3 - 103.5
OPP1072 L	L	103.5 - 113.7
OPP1072 XL	XL	113.7 - 126.4

Note: Measure around the chest (cm).



Oppo 2172 Reinforced Shoulder Support

- Two reinforced elastic straps on upper arm provide extra support for the shoulder
- Allows the patient gradually return to full range of motion
- Fits left or right

✓ DVA: RAP# AR03 (all codes) For more information please refer to pg 7.

Code	Size	cm
OPP2172 S	S	81.6 - 91.8
OPP2172 M	M	91.8 - 101.9
OPP2172 L	L	101.9 - 114.6
OPP2172 XL	XL	114.6 - 127.3

Note: Measure around the chest (cm).



Barrere Clavicle Brace

- Padded 'figure of eight' shoulder straps
- One size fits all

✓ DVA: RAP# AR03 (all codes) For more information please refer to pg 7.

Code	Description	Size
B422	Barrere Clavicle Brace	Universal Size

Note: One size fits all.



Oppo 2075 Clavicle Brace

- Excellent aid in correcting poor posture and shoulder slump
- Adjustable hook and loop closure facilitates proper fit

✓ DVA: RAP# AR03 (all codes) For more information please refer to pg 7.

Code	Size	(cm)
OPP2075S	S	53.7 - 63.8
OPP2075M	M	63.8 - 76.5
OPP2075L	L	76.5 - 89.2
OPP2075XL	XL	89.2 - 104.5
OPP2075XXL	XXL	104.5 - 117.2
OPP2075XXXL	XXXL	117.2 - 129.9

Note: Measure around scapula under arm.



Oppo 4072 Humerus Brace

- Padded webbing strap fits under the opposite axilla
- Hook and loop closure for quick, easy, adjustable application and removal

✓ DVA: RAP# AR03 (all codes) For more information please refer to pg 7.

Code	Size	(cm)
OPP4072 S	S	24 - 29
OPP4072 M	M	29 - 34
OPP4072 L	L	34 - 39

Note: Measure mid upper arm circumference (cm).



Rolyan Hemi Arm Sling II

- Positions the head of the humerus in the glenoid fossa and the scapula in external rotation
- Optional universal cuff adapter A653-11 available - positions the hand above heart to treat or prevent edema. Attaches to a d-ring on the unaffected side. length 18cm, colour white
- Elastic straps are dynamic, allowing a patient to actively move returning muscles and perform self-ranging exercises

✓ DVA: RAP# AR03 (all codes) For more information please refer to pg 7.

Code - Left	Code - Right	Size	(cm)	Chest
A6531	A6532	S	36 - 46	
A6533	A6534	M	46 - 61	78 - 89
A6535	A6536	M Long	46 - 61	89 - 102
A6537	A6538	L	61 - 71	
A6539	A65310	XL	71 - 86	

Note: To fit, measure the distance from acromion to acromion posteriorly across the midpoint of the scapula. To determine if patient is medium or medium long, measure the chest circumference at the axilla.

- Approximately 3.8cm longer than the original model



Rolyan MFC II Shoulder Orthosis

- Lycra/spandex fabric offers excellent conformability to body contours for a snug fit
- Easy to put on and take off
- Can be worn under clothing
- Hand wash, air dry

✓ DVA: RAP# AR03 (all codes) For more information please refer to pg 7.

Code - Left	Code - Right	Size	(cm)
A54551	A54552	XS	23 - 28
A54561	A54562	S	28 - 33
A54571	A54572	M	33 - 38

Note: Measure circumference of mid upper-arm.



Rehband 5055 Acro Comfort Shoulder Support

- Stabilises the shoulder joint
- Stretch flex system is anatomically designed for optimal function
- Excellent comfort through the temperature regulating features of comfortemp®
- Fits left or right

✓ DVA: RAP# AR03 (all codes) For more information please refer to pg 7.

Code	Size	(cm)
REH5055 XS	XS	24 - 28
REH5055 S	S	28 - 32
REH5055 M	M	32 - 35
REH5055 L	L	35 - 38
REH5055 XL	XL	38 - 42

Note: Measure circumference around the shoulder joint going under the arm (cm).



Rehband 1068 EQ Posture Support

- A flexible aid for training a better posture
- Bendable stays for additional support
- Elastic and well-fitting
- Wear with singlet or t-shirt underneath
- Sizing: waist circ (cm)

✓ DVA: RAP# AR03 (all codes) For more information please refer to pg 7.

Code	Size	(cm)
REH1068 XS	XS	56 - 64
REH1068 S	S	64 - 72
REH1068 M	M	72 - 80
REH1068 L	L	80 - 90
REH1068 XL	XL	90 - 100



Oppo 2175 Posture Aid

- Triangle configuration correctly distributes pressure to tip of shoulder
- Suitable for adults or children
- Adjustable hook and loop closure facilitates proper fit

✓ DVA: RAP# AR03 (all codes) For more information please refer to pg 7.

Code - Left	Size	(cm)
OPP2175S	S	64.1 - 76.5
OPP2175M	M	76.5 - 89.2
OPP2175L	L	89.2 - 104.5
OPP2175XL	XL	104.5 - 117.2
OPP2175XXL	XXL	117.2 - 129.9

Note: Measure around scapula under arm.



Dale Rib Belt - Male

- 15cm width, 2 panel construction
- Provides comfortable reassuring pressure around rib cage
- Allows full breathing and mobility
- Easy to apply and remove with infinitely adjustable velcro closure for perfect fit
- Also suitable as narrow abdominal binder

✓ DVA: RAP# AR08 (all codes) For more information please refer to pg 7.

Code	Description	Size	(cm)
D0525	Dale Rib Belt - Male Regular	Regular	70 - 130
D0527	Dale Rib Belt - Male Long	Long	115 - 150

Note: Measure around the chest (cm).



Dale Rib Belt - Female

- 5cm width, 2 panel construction
- Shaped for comfortable fit under breasts
- Soft-rolled upper edge to prevent breast irritation.
- Provides comfortable reassuring pressure around rib cage
- Allows full breathing and mobility
- Easy to apply and remove with infinitely adjustable velcro closure

✓ DVA: RAP# AR08 (all codes) For more information please refer to pg 7.

Code	Description	Size	(cm)
D0425	Dale Rib Belt - Female	One Size	70 - 130

Note: Measure around the chest (cm).



Dale Abdominal Binder

- Single ply stretch loop elastic (latex-free)
- Velcro closure anywhere on belt for perfect fit
- Provides full, even pressure and aids abdominal muscle
- Colour white
- Sizing: available in either 23cm (pictured) or 30cm widths, both in S, M and L sizes

✓ DVA: RAP# AR08 (all codes) For more information please refer to pg 7.

Code - 23cm Width	Code - 30cm Width	Size	Circum. (cm)
DO 410	DO 810	S	Up to 114
DO 411	DO 811	M	114 - 157
DO 418	DO 818	L	152 - 191

Note: Measure circumference of male waist/female hips.



Oppo 2060 Abdominal Binder - Firm

- Made of a combination of elastic and soft nylon pile bonded to 6mm foam for comfort
- Elastic panel construction provides even support; prevents "roll over"
- Contoured to fit between waist and hips

✓ DVA: RAP# AR08 (all codes) For more information please refer to pg 7.

Code	Size	(cm)
OPP2060 S	S	61.6 - 81.3
OPP2060 M	M	81.3 - 94
OPP2060 L	L	94 - 104.1
OPP2060 XL	XL	104.1 - 114.3
OPP2060 XXL	XXL	114.3+

Note: Measure around the waist.



Dale Abdominal Lumbar Support

- Single ply stretch loop elastic (latex-free)
- Two removable aluminium supports
- Supports can be hand-shaped to hip curvature
- Velcro closure anywhere on belt for perfect fit
- Colour white
- Sizing: available in either 23cm (pictured) or 30cm widths, both in S, M and L sizes

✓ DVA: RAP# AR08 For more information please refer to pg 7.

Code - 23cm Width	Code - 30cm Width	Size	Circ. (cm)	RAP #:
DO 442	DO 842	S	Up to 114	AR08
DO 443	DO 843	M	114 - 157	AR08
DO 448	DO 848	L	152 - 191	-

Note: Measure circumference of male waist/female hips.



Oppo 2263 Lumbar Sacral Support

- Built-in flexible stays provide additional support and prevent rolling
- Double layer design for adjustable compression
- Ventilated material for breath-ability and comfort
- Flexible stays provide stabilizing support to the abdominal muscles
- Two flexible stays keep the belt smooth in the front for comfort when sitting

✓ DVA APPROVED: RAP#: AR08 For more information please refer to pg 7.

Code	Size	(cm)
OPP2263 S	S	58.4 - 71.1
OPP2263 M	M	71.1 - 83.8
OPP2263 L	L	83.8 - 96.5
OPP2263 XL	XL	96.5 - 109.2
OPP2263 XXL	XXL	109.2 - 121.9

Note: Measure around the waist.

- Removable pad provides extra compression to the lower back



Oppo 2267 Lumbar Sacral Support - Light

- Extra stays provide effective back support
- Elastic reinforced straps for a perfect fit
- Breathable elastic mesh fabric ensures comfort
- May be worn under clothing and will not hinder daily activities

✓ DVA: RAP# AR08 (all codes) For more information please refer to pg 7.

Code	Size	(cm)
OPP2267S	S	58.4 - 71.1
OPP2267M	M	71.1 - 83.8
OPP2267L	L	83.8 - 96.5
OPP2267XL	XL	96.5 - 109.2
OPP2267XXL	XXL	109.2 - 121.9

Note: Measure around the waist.



Oppo 2265 Lumbar Sacral Support - Tapered

- Four removable posterior flexible aluminum stays support the lower back
- Two flexible stays in front help reduce rolling of the support when sitting
- Allows limited flexion and extension
- 25cm high at back, tapered to 17.5cm at front

✓ DVA: RAP# AR08 (all codes) For more information please refer to pg 7.

Code	Size	(cm)
OPP2265 S	S	58.4 - 71.1
OPP2265 M	M	71.1 - 83.8
OPP2265 L	L	83.8 - 96.5
OPP2265 XL	XL	96.5 - 109.2
OPP2265 XXL	XXL	109.2 - 121.9

Note: Measure around the waist.



Oppo 2264 Lumbar Sacral Support - Foam

- Designed with straps crossing at the back and fastened in front
- Comfortable to wear and provides excellent support
- Four pliable support splints at the back for extra stability
- Breathable elastic/cotton and soft pile bonded to foam
- 22.8cm back depth

✓ DVA: RAP# AR08 (all codes) For more information please refer to pg 7.

Code	Size	(cm)
OPP2264 S	S	58.4 - 71.1
OPP2264 M	M	71.1 - 83.8
OPP2264 L	L	83.8 - 96.5
OPP2264 XL	XL	96.5 - 109.2
OPP2264 XXL	XXL	109.2 - 121.9
OPP2264 XXXL	XXXL	122 - 135

Note: Measure around the waist.



Oppo 2061 Lumbar Sacral Belt

- Provides support and variable compression to the sacrum and sacroiliac region of the spine
- 50% cotton blend
- Used for therapeutic or prophylactic support
- Ideal for sport medicine

✓ DVA: RAP# AR08 (all codes) For more information please refer to pg 7.

Code	Description	Size	(cm)
OPP2061	Oppo 2061 Lumbar Sacral Belt	One size	66 - 91.4

Note: Measure around the waist.



Oppo 2066 Lumbar Sacral Support - X-strap

- Made of light, breathable elastic multiband material
- 59% cotton
- Provides comfortable and extraordinary support with four pliable metal splints in the back
- Designed with straps crossing at the back and provides excellent support
- Depth at back: 22.8cm

✓ DVA: RAP# AR08 (all codes) For more information please refer to pg 7.

Code	Size	(cm)
OPP2066S	S	58.4 - 71.1
OPP2066M	M	71.1 - 83.8
OPP2066L	L	83.8 - 96.5
OPP2066XL	XL	96.5 - 109.2

Note: Measure around the waist.



Oppo 2065 Lumbar Sacral Support

- Designed with straps crossing at the back and fastened in front
- Comfortable to wear with 59% cotton content, and provides excellent support
- Four pliable support splints at the back for extra stability
- Choice of 2 back heights, 23cm and 30cm (pictured)

✓ DVA: RAP# AR08 (all codes) For more information please refer to pg 7.

Code - 23cm Width	Code - 30cm Width	Size	Circ. (cm)
OPP2065-9 S	OPP2065-12 S	S	58.4 - 71.1
OPP2065-9 M	OPP2065-12 M	M	71.1 - 83.8
OPP2065-9 L	OPP2065-12 L	L	83.8 - 96.5
OPP2065-9 XL	OPP2065-12 XL	XL	96.5 - 109.2
OPP2065-9 XXL	OPP2065-12 XXL	XXL	109.2 - 121.9

Note: Measure around the waist.



Oppo 2164 Lumbar Sacral Support - Multiband

- Designed with straps crossing at the back and fastened in front
- Comfortable to wear, and provides excellent support
- Four pliable support splints at the back for extra stability
- Breathable elastic/cotton blend and soft pile bonded to foam

✓ DVA: RAP# AR08 (all codes) For more information please refer to pg 7.

Code	Size	(cm)
OPP2164 S	S	58.4 - 71.1
OPP2164 M	M	71.1 - 83.8
OPP2164 L	L	83.8 - 96.5
OPP2164 XL	XL	96.5 - 109.2
OPP2164 XXL	XXL	109.2 - 121.9

Note: Measure around the waist.



Oppo 2261 Light Industrial Back Support

- Two extra stays on the back provide effective back support
- May be worn under clothing and will not hinder daily activities
- Breathable elastic/cotton mesh fabric ensures comfort
- Elastic reinforced straps for a custom fit
- Back height 25.4cm

✓ DVA: RAP# AR08 (all codes) For more information please refer to pg 7.

Code	Size	(cm)
OPP2261S	S	58.4 - 71.1
OPP2261M	M	71.1 - 83.8
OPP2261L	L	83.8 - 96.5
OPP2261XL	XL	96.5 - 109.2
OPP2261XXL	XXL	109.2 - 121.9

Note: Measure around the waist.



Oppo 2169 Back Support/ Shoulder Straps

- Helps prevent and relieve lower back pain
- Easy to apply and remove
- Shoulder straps enable user to affix when needed for lifting or bending
- May be used for both the lumbar and lumbosacral regions
- Four pliable support splints in the back for extra stability

✓ DVA: RAP# AR08 (all codes) For more information please refer to pg 7.

Code	Size	(cm)
OPP2169 S	S	73.7 - 83.8
OPP2169 M	M	83.8 - 96.5
OPP2169 L	L	96.5 - 109.2
OPP2169 XL	XL	109.2 - 124.5
OPP2169 XXL	XXL	124.5 - 137.2

Note: Measure around the waist.



Rehband 1069 Dosi EQX Straight Fit

- Classic back support for straighter figure
- 22cm width
- Four stabilising splints in back
- Adjustable cross-strap for individual support

✓ DVA: RAP# AR08 (all codes) For more information please refer to pg 7.

Code	Size	(cm)
REH1069 XS	XS	56 - 64
REH1069 S	S	64 - 72
REH1069 M	M	72 - 80
REH1069 L	L	80 - 90
REH1069 XL	XL	90 - 100
REH1069 XXL	XXL	100 - 110

Note: Measure around the waist.



Rehband 1079 Dosi EQ SI Shaped Fit

- Classic back support for curved (female) figure
- 22cm width
- Four stabilising splints in back
- Adjustable cross-strap for individual support

✓ DVA: RAP# AR08 (all codes) For more information please refer to pg 7.

Code	Size	(cm)
REH1079 XS	XS	56 - 64
REH1079 S	S	64 - 72
REH1079 M	M	72 - 80
REH1079 L	L	80 - 90
REH1079 XL	XL	90 - 100
REH1079 XXL	XXL	100 - 110

Note: Measure around the waist.



Rehband 1070 Dosi EQ SI High Fit

- Classic back support, in high fit
- 30cm width
- Covers the lower back and half of the thoracic
- Four stabilising splints in back
- Adjustable cross-strap for individual support

✓ DVA: RAP# AR08 (all codes) For more information please refer to pg 7.

Code	Size	(cm)
REH1070 S	S	64 - 72
REH1070 M	M	72 - 80
REH1070 L	L	80 - 90
REH1070 XL	XL	90 - 100
REH1070 XXL	XXL	100 - 110

Note: Measure around the waist.



Body Assist 100 Lumbar Sacral Support

- Cotton/elastic lumbar support belt
- Four medical support stays
- Hook and loop tape closure
- Elastic construction with medical support stays for extra stability
- Lifts the belly, alleviating some pressure placed on the spine & lower back
- For people who are seated for long periods of time

✓ DVA: RAP# AR08 (all codes) For more information please refer to pg 7.

Code	Size	(cm)
NH 100 0	S	65 - 75
NH 100 1	M	75 - 85
NH 100 2	L	85 - 95
NH 100 3	XL	95 - 105
NH 100 4	XXL	105 - 115
NH 100 5	XXXL	115 - 125

Note: Measure around the waist.

- Ideal in warmer climates



Body Assist 105 Deluxe Sacro Cinch Support

- Elastic / lycra support with two layers of enclosure
- Front split design for perfect fit of waist/hips
- The upper side pull closure, wraps neatly around the waist, while the lower straps close perfectly over the hips

✓ DVA: RAP# AR08 (all codes) For more information please refer to pg 7.

Code	Size	(cm)
NH 105 1	S	75 - 85
NH 105 2	M	85 - 95
NH 105 3	L	95 - 105
NH 105 4	XL	105 - 115

Note: Measure around the waist.



Body Assist 109 Sacro Cinch

- Cool, breathable lightweight lycra and elastic construction
- Incorporates two layers of closure, giving firm but comfortable support to the lower back
- Incorporates pliable support stays for extra stability

✓ DVA: RAP# AR08 (all codes) For more information please refer to pg 7.

Code - Beige	Code - Black	Size	(cm)
NH 109 S0	NH 109 B0	S	65 - 75
NH 109 S1	NH 109 B1	M	75 - 85
NH 109 S2	NH 109 B2	L	85 - 95
NH 109 S3	NH 109 B3	XL	95 - 112
NH 109 S4	NH 109 B4	XXL	112 - 130

Note: Measure around the waist.



Elastic Sacro Cinch Support

- Made of firm elastic with webbing cinch straps
- Reduces intradiscal pressure by increasing intra-abdominal pressure
- Velcro closure with cinch pull strap
- Two posterior metal stays, which need to be shaped at time of fitting
- Back length 25cm, front length 19cm
- Straighter male fit, and shaped female fit

✓ DVA: RAP# AR08 (all codes) For more information please refer to pg 7.

Code - Male	Code - Female	Size	(cm)
G21005M S	G21005F S	S	76 - 86
G21006M M	G21006F M	M	87 - 96
G21007M L	G21007F L	L	97 - 106
G21008M XL	G21008F XL	XL	107 - 116
G21009M XXL	G21009F XXL	XXL	117 - 126

Note: Measure around the waist.



Elastic Sacro Cinch Support - Long Fit

- Made of firm elastic with webbing cinch straps
- Reduces intradiscal pressure by increasing intra-abdominal pressure
- Velcro closure with cinch pull strap
- Two posterior metal stays, which need to be shaped at time of fitting
- Back length 36cm, front length 22cm

✓ DVA: RAP# AR08 (all codes) For more information please refer to pg 7.

Code - Male	Size	(cm)
C22051 S	S	76 - 86
C22051 M	M	87 - 96
C22051 L	L	97 - 106
C22051 XL	XL	107 - 116
C22051 XXL	XXL	117 - 126

Note: Measure around the waist.



Barrere 353 Lumbar Sacral Belt - Female Shaped Fit

- Shaped fit for female curvature
- Made of firm elastic with webbing cinch straps
- Reduces intradiscal pressure by increasing intra-abdominal pressure
- Velcro closure with cinch strap
- Two posterior metal stays, which need to be shaped at time of fitting
- Back length 24cm, front length 13cm

✓ DVA: RAP# AR08 (all codes) For more information please refer to pg 7.

Code	Size	(cm)
B 353 1	XS	69 - 75
B 353 2	S	75 - 83
B 353 3	M	83 - 92
B 353 4	L	92 - 102
B 353 5	XL	102 - 112
B 353 6	XXL	112 - 120
B 353 7	XXXL	120 - 130

Note: Measure around top of hips.



Barrere 355 Lumbar Sacral Belt – Male Straight Fit

- Straight fit suitable for normal male shape
- Made of firm elastic with webbing cinch straps
- Reduces intradiscal pressure by increasing intra-abdominal pressure
- Velcro closure with cinch strap
- Two posterior metal stays, which need to be shaped at time of fitting
- Back length 29cm, front length 18cm

✓ DVA: RAP# AR08 (all codes) For more information please refer to pg 7.

Code	Size	(cm)
B 355 1	XS	69 - 75
B 355 2	S	75 - 83
B 355 3	M	83 - 92
B 355 4	L	92 - 102
B 355 5	XL	102 - 112
B 355 6	XXL	112 - 120
B 355 7	XXXL	120 - 130

Note: Measure around top of hips.



Oppo 1063 Neoprene Back Belt - Univeoprene

- Provides maximum support to mid and lower back without restricting normal movement
- Three flexible stays on the back provide extra support
- Retains body heat for constant moist heat to lower back muscle group
- Hook and loop closure allows for a wide range of adjustable compression

✓ DVA: RAP# AR08 (all codes) For more information please refer to pg 7.

Code	Description	Size	(cm)
OPP1063	Oppo 1063 Neoprene Back Belt - Univ (Beige)	One size	71.1 - 116.8

Note: Measure around the waist.



Oppo 1064 Lumbar Support - Neoprene

- Provides support for lower back injuries
- Maximum support to mid and lower back without restricting normal movement
- Three flexible stays on the back provide extra support
- Hook and loop closure allows for a wide range of adjustable compression
- Two extra straps provide more support and stability

✓ DVA: RAP# AR08 (all codes) For more information please refer to pg 7.

Code	Size	(cm)
OPP1064S	S	61.0 - 78.7
OPP1064M	M	78.7 - 89.5
OPP1064L	L	89.5 - 99.7
OPP1064XL	XL	99.7 - 110.5
OPP1064XXL	XXL	110.5 - 121.3

Note: Measure around the waist.

- 25cm width back shape provides extra support



McDavid A491 Waist Belt - Thermal

- Adjustable thermal waist belt that delivers various levels of compression with therapeutic warmth
- The shaped design and adjustable closures assures an optimum fit
- One size fits up to a 127cm or 50in waist

✓ DVA: RAP# AR08 (all codes) For more information please refer to pg 7.

Code	Description	Size
NH A491	McDavid A491 Waist Belt - Thermal Beige	Universal size
NH A491B	McDavid A491 Waist Belt - Thermal Black	Universal size



McDavid A493/A494 Sacro Cinch Support - Thermal

- Made of lweight lycra, thermal rubber & orthopaedic elastic that delivers firm support
- The A494 model with shoulder straps enables the user to affix when needed for lifting or bending
- Two layer closure. The first layer consists of heat retaining medical neoprene across the lower back, attached to lycra panels
- The outer straps deliver firm, powerful support when attached

✓ DVA: RAP# AR08 (all codes) For more information please refer to pg 7.

Code - No Shoulder Straps (pictured)	Code - with Shoulder Straps	Size	(cm)
NHA493 1	NHA494 1	S	60 - 80
NHA493 2	NHA494 2	M	67 - 105
NHA493 3	NHA494 3	L	90 - 132
NHA493 4	NHA494 4	XL	115 - 150

Note: Measure around the waist.

- When closed the first layer delivers mild compression so the brace to be worn without effect
- 5 pliable support stays



Body Assist 103 Lumbar Sacral Support – Neoprene

- Thermal neoprene delivers therapeutic warmth & protection to soft tissue
- Anatomically designed to fit perfectly
- Includes 4 rigid medical splints & 4 flexible spiral side stays
- Inc 2 layers of closure
- Outer straps deliver firm, orthopaedic support

✓ DVA: RAP# AR08 (all codes) [For more information please refer to pg 7.](#)

Code - Beige	Code - Black	Size	(cm)
NH103 S1	NH103 B1	S - M	Up to 85
NH103 S2	NH103 B2	L - XL	85 - 105

Note: Measure around the waist.

- Inner layer consists of thermal neoprene delivering minimal-to-mild compression



Barrere Lumbar Sacral Side-Lacing Corset - Female

- Female
- Lumbo-sacral
- Side-laced
- Steel back stays
- Hook & eye fastening

✓ DVA: RAP# AR14 (all codes) [For more information please refer to pg 7.](#)

Code	Description	Size
B301	Barrere Lumbar Sacral Side-Lacing Corset - Female	Contact Cosmac for required measurements



Barrere Lumbar Sacral Front-Lacing Corset - Female

- Female
- Lumbo-sacral
- Front-laced
- Steel back stays
- Hook & eye fastening

✓ DVA: RAP# AR08 (all codes) [For more information please refer to pg 7.](#)

Code	Description	Size
B303	Barrere Lumbar Sacral Front-Lacing Corset - Female	Contact Cosmac for required measurements



Barrere Lumbar Sacral Abdominal Side-Lacing Corset - Female

- Female
- Lumbo-sacral and abdominal support
- Side-laced
- Steel back stays
- Hook & eye fastening

✓ DVA: RAP# AR14 (all codes) [For more information please refer to pg 7.](#)

Code	Description	Size
B313	Barrere Lumbar Sacral Abdominal Side-Lacing Corset - Female	Contact Cosmac for required measurements



Barrere Lumbar Sacral Side-Lacing Corset - Long - Male

- Male
- Lumbo-sacral corset
- Long model
- Side-laced
- Steel back stays
- Hook & eye fastening

✓ DVA: RAP# AR14 (all codes) [For more information please refer to pg 7.](#)

Code	Description	Size
B382	Barrere Lumbar Sacral Side-Lacing Corset - Long - Male	Contact Cosmac for required measurements



Barrere Lumbar Sacral Side-Lacing Corset - Short - Male

- Male
- Lumbo-sacral and abdominal support
- Side-laced
- Steel back stays
- Hook & eye fastening

DVA: RAP# AR14 (all codes) [For more information please refer to pg 7.](#)

Code	Description	Size
B381	Barrere Lumbar Sacral Side-Lacing Corset - Short - Male	Contact Cosmac for required measurements



Aspen TLSO - Thoraco Lumbar Sacral Bracing System

- The Aspen TLSO is a prefabricated, custom fitted orthosis
- Constructed of three rigid plastic shells including the rigid posterior panel and two rigid side panels
- Together with the padded chest panel, shoulder straps and torso control straps, the aspen tlo provides triplanar motion restriction
- Requiring several specific anatomical measurements and characterized by a structurally rigid layer of high density polyethylene that encircles the trunk, the Aspen TLSO is designed to be trimmed, bent, molded or modified for use by a specific patient

DVA: RAP# AR08 (all codes) [For more information please refer to pg 7.](#)

Code - TLSO	Replacement pads codes	Size	Back Panel Ht. (cm)	Cut-Out Ht. (cm)	Circum. (cm)
AS991030	AS991035	S/S - Short/Small	33	20	66 - 99
AS991031	AS991036	S/L - Short/Large	33	20	91 - 124
AS991070	AS991075	T/S - Tall/Small	41	25	81 - 119
AS991071	AS991076	T/L - Tall/Large	41	25	112 - 150



Aspen LSO - Lumbar-Sacral Bracing System

- The Aspen LSO is a prefabricated, custom fitted body jacket style orthosis made from high density polyethylene and rigid aluminum rods with a cotton-lined foam interface material

DVA: RAP# AR08 (all codes) [For more information please refer to pg 7.](#)

Code - LSO	Replacement pads codes	Size	Back Panel Ht. (cm)	Cut-Out Ht. (cm)	Circum. (cm)
AS990040	AS990045	S/S - Short/Small	33	20	66 - 99
AS990041	AS990046	S/L - Short/Large	33	20	91 - 124
AS990060	AS990065	T/S - Tall/Small	41	25	81 - 119
AS990061	AS990066	T/L - Tall/Large	41	25	112 - 150



Body Excel Back Support

- A multi functional back support
- Achieves optimum abdominal compression, so critical to effective lower back support
- The cord has 10 times the tensile strength of steel
- Patented pulley system delivers six times more support power than any other sacro cynch back brace
- There is a lifetime warranty on the pulley system and cords

DVA: RAP# AR08 (all codes) [For more information please refer to pg 7.](#)

Code	Size	(cm)
BXL S	S	63 - 76
BXL M	M	76 - 89
BXL L	L	91 - 102
BXL XL	XL	102 - 115
BXL XXL	XXL	115 - 127



Body Assist 95 Elbow Sleeve

- Provides a basic level of compression and orthopaedic support

✓ DVA: RAP# AR03 (all codes) For more information please refer to pg 7.

Code	Description	Size	(cm)
NH95 1	Body Assist 95 elbow sleeve Small	S	20 - 25
NH95 2	Body Assist 95 elbow sleeve Medium	M	25 - 28
NH95 3	Body Assist 95 elbow sleeve Large	L	28 - 30
NH95 4	Body Assist 95 elbow sleeve Extra Large	XL	30 +

Measure elbow circumference.



McDavid A488 Thermal Elbow Wrap

- Multi-purpose elbow wrap provides warmth, firm compression and some protection
- Contoured and darted for a better fit
- Velcro closure ensures the best fit
- Fully adjustable

✓ DVA: RAP# AR03 (all codes) For more information please refer to pg 7.

Code	Colour	Description
NHA488 S	Beige	McDavid A488 thermal elbow wrap
NHA488 B	Black	McDavid A488 thermal elbow wrap

Measure elbow circumference.



Oppo 1085 Elbow Sleeve

- Provides full support of elbow region in conjunction with reducing of the insertion of the extensor carpi radialis tendon
- Provides support and protection during activities which require extensive elbow

✓ DVA: RAP# AR03 (all codes) For more information please refer to pg 7.

Code	Description	Size	(cm)
OPP1085 1	Oppo 1085 elbow sleeve S	S	23.2 - 25
OPP1085 2	Oppo 1085 elbow sleeve M	M	25.7 - 28
OPP1085 3	Oppo 1085 elbow sleeve L	L	28.3 - 30
OPP1085 4	Oppo 1085 elbow sleeve XL	XL	30.8 - 33

Measure elbow circumference.



Oppo 2080 Elbow Sleeve

- Provides support and compression to the elbow joint without restricting flexibility
- Retains heat to relieve pain

✓ DVA: RAP# AR03 (all codes) For more information please refer to pg 7.

Code	Description	Size	(cm)
OPP2080 1	Oppo 1085 elbow sleeve S	S	23.2 - 26
OPP2080 2	Oppo 1085 elbow sleeve M	M	25.7 - 31.1
OPP2080 3	Oppo 1085 elbow sleeve L	L	31.1 - 37.5
OPP2080 4	Oppo 1085 elbow sleeve XL	XL	37.5 - 43.5

Measure elbow circumference.



Rehband 7124 Hyper-Extension Elbow Brace

- Prevents hyper-extension of the elbow
- Constructed of warming neoprene
- Metal splints
- Cross-wise straps prevent hyper extension

✓ DVA: RAP# AR03 (all codes) For more information please refer to pg 7.

Code	Description	Size	(cm)
REH7124 XS	Rehband 7124 Hyper - Ex elbow brace XS	XS	21 - 23
REH7124 S	Rehband 7124 Hyper - Ex elbow brace S	S	23 - 25
REH7124 M	Rehband 7124 Hyper - Ex elbow brace M	M	25 - 28
REH7124 L	Rehband 7124 Hyper - Ex elbow brace L	L	28 - 31
REH7124 XL	Rehband 7124 Hyper - Ex elbow brace XL	XL	31 - 33

Measure forearm circumference.



Rolyan DynaPro Flex Elbow

- Abnormal reflex arc therapy provided by the device assists in neuro-rehabilitation
- Axial hinge with legible goniometer facilitates brace fitting
- Elbow cuff extenders available
- New fabric reduces shea/friction
- Gel elbow pad included

✓ DVA: RAP# AR03 (all codes) For more information please refer to pg 7.

Code	Size	Upper Arm:	Lower Arm
OC-DPFE 20724S	S	20.3 - 25.4	12.7 - 20.3
OC-DPFE 20724M	M	22.8 - 29.2	19.0 - 25.4
OC-DPFE 20724L	L	27.9 - 35.5	22.8 - 30.5

Upper Arm: circ (cm) around mid upper-arm Lower Arm: circumference (cm) around mid - lower arm.



Rolyan Progressive Elbow/Knee Splint

- Provides soft, comfortable positioning with secure support while gently increasing the range of motion of elbow
- 3-part Ezeform stay needs to be formed to patient and can be reformed as needed
- Hand wash, air dry
- Latex free

✓ DVA: RAP# AR03 (all codes) For more information please refer to pg 7.

Code	Description	Size	(cm)
A812410	Rolyan progressive elbow/knee splint XS	XS	Up to 27
A812411	Rolyan progressive elbow/knee splint S	S	27 - 38
A812412	Rolyan progressive elbow/knee splint M	M	39 - 44
A812413	Rolyan progressive elbow/knee splint L	L	45 - 50
A812414	Rolyan progressive elbow/knee splint L	XL	51 - 56

Measure arm circ 5cm above elbow.
Min 5cm clearance from axillary necessary.



Rolyan Adjustable Elbow/Knee Splint

- Polystyrene beads conform to the user, providing comfortable, adjustable positioning without areas of increased pressure
- Positions elbow or knee to passively immobilize and help protect joint
- Adjusts to individual by simply adding or removing beads through zippered opening
- Vinyl-coated mesh fabric cover with cotton lining

✓ DVA: RAP# AR03 (all codes) For more information please refer to pg 7.

Code	Description	Size	(cm)
A81240	Rolyan adjustable elbow/knee splint XS	XS	Up to 17
A81241	Rolyan adjustable elbow/knee splint S	S	17 - 23
A81242	Rolyan adjustable elbow/knee splint M	M	23 - 30
A81243	Rolyan adjustable elbow/knee splint L	L	30 - 38
A81244	Rolyan adjustable elbow/knee splint XL	XL	38 - 46

Measure arm circumference at joint.



Oppo 1080 Tennis Elbow Brace

- Provides full support of elbow region in conjunction with reducing of the insertion of the extensor carpi radialis tendon
- Circular pad for extra pressure on the muscle in the arm or wrist
- Adjustable compressive strap reduces tension in wrist and finger extensors during gripping

✓ DVA: RAP# AR03 (all codes) For more information please refer to pg 7.

Code	Description	Size	(cm)
OPP1080 1	Oppo 1080 tennis elbow brace XS	S	23.2 - 25.7
OPP1080 2	Oppo 1080 tennis elbow brace S	M	25.7 - 28.3
OPP1080 3	Oppo 1080 tennis elbow brace M	L	28.3 - 30.8
OPP1080 4	Oppo 1080 tennis elbow brace L	XL	30.8 - 33.3

Measure elbow circumference.

- Tennis elbow
- Golfer's elbow



Oppo 1086 Tennis Elbow Support

- Relieves pain from strained muscles in the forearm
- Circular pad for extra pressure on the muscle in the arm or wrist
- Adjustable hook and loop strap for greater tension if needed
- One size fits most
- Tennis elbow

✓ DVA: RAP# AR03 (all codes) For more information please refer to pg 7.

Code	Description	Size	(cm)
OPP1086	Oppo 1086 tennis elbow support	Universal	17.8 - 33



Oppo 1486 Tennis Elbow Support With Silicone Pad

- Specially shaped silicone inserts surrounding the epicondyles and the adjoining radial
- Oedema and hematoma are quickly reabsorbed
- Rapidly improves the joint function

✓ DVA: RAP# AR03 (all codes) [For more information please refer to pg 7.](#)

Code	Description	Size	(cm)
OPP1486	Oppo 1486 tennis elbow support with silicone pad	Universal	17.8 - 33

Measure forearm circ (cm).

- Relieves the strain on the periarticular tissues and compresses the soft tissue area
- One size fits most



Oppo 3086 Tennis Elbow Brace

- Detachable inner pad may be removed for cleaning
- Raised soft foam may be positioned to reduce muscle loading
- Clasp plastic provides pressure evenly on musculature around the elbow

✓ DVA: RAP# AR03 (all codes) [For more information please refer to pg 7.](#)

Code	Description	Size	(cm)
OPP3086 1	OPPO 3086 tennis elbow brace S	S	24.1 - 25.4
OPP3086 2	OPPO 3086 tennis elbow brace M	M	25.4 - 27.3
OPP3086 3	OPPO 3086 tennis elbow brace L	L	27.3 - 29.8
OPP3086 4	OPPO 3086 tennis elbow brace XL	XL	27.3 - 29.8

Measure elbow circumference.

- Adjustable hook and loop closure for a comfortable fit and stabilization during daily activities



Rehband 4801 Epiflex Tennis Elbow Brace

- Neoprene/elastic elbow support provides relief of the tendon insertion
- Easy fastening buckles allow adjustment of compression

✓ DVA: RAP# AR03 (all codes) [For more information please refer to pg 7.](#)

Code	Description	Size	(cm)
REH4801S	Rehband 4801 epiflex tennis elbow brace S	S	24 - 25
REH4801M	Rehband 4801 epiflex tennis elbow brace M	M	26 - 27
REH4801L	Rehband 4801 epiflex tennis elbow brace L	L	28 - 30
REH4801XL	Rehband 4801 epiflex tennis elbow brace XL	XL	31 - 33

Measure elbow circumference.



Rehband 7122 Epi Ulna Tennis Elbow Support

- A warming elbow support which provides relief of the tendon insertion
- Warming neoprene
- Adjustable width for the arm

✓ DVA: RAP# AR03 (all codes) [For more information please refer to pg 7.](#)

Code	Size	(cm)
REH7122 XS	XS	21 - 23
REH7122 S	S	23 - 25
REH7122 M	M	25 - 28
REH7122 L	L	28 - 31
REH7122 XL	XL	31 - 33
REH7122 XXL	XXL	33 - 36

Therapy & Exercise



Rehband 7123 Medical Epi Forsa Tennis Elbow Support

- Neoprene elbow support, which provides relief of the tendon insertion
- Easy to adjust with two movable pelottes
- One size fits all

✓ DVA: RAP# AR03 (all codes) [For more information please refer to pg 7.](#)

Code	Description
REH7123	Rehband 7123 medical Epi Forsa tennis elbow support

Measure elbow circumference.



Body Assist 970 Tennis Elbow Band

- Rigid, non - stretch strap
- Heavy duty D - loop closure for snug fit
- Incorporates pressure pad
- One size fits all

✓ DVA: RAP# AR03 (all codes) For more information please refer to pg 7.

Code	Description	Size
NH970	Body Assist 970 tennis elbow band	Universal



McDavid A486 Thermal Tennis Elbow Strap

- Applies pressure over the tendons
- Rigid velcro cinch-strap closes neatly over a neoprene inner wrap
- Shaped design with adjustable touch tape closure

✓ DVA: RAP# AR03 (all codes) For more information please refer to pg 7.

Code	Description	Size
NHA486	McDavid A486 thermal tennis elbow strap	Universal



McDavid A485 Thermal Tennis Elbow Support

- Heavy-duty neoprene sleeve with rigid cinch strap
- Applies pressure over the tendon
- Delivers therapeutic heat and protection to the elbow joint

✓ DVA: RAP# AR03 (all codes) For more information please refer to pg 7.

Code	Description	Size	(cm)
NHA485 1	McDavid A485 thermal tennis elbow support S	S	20 - 24
NHA485 2	McDavid A485 thermal tennis elbow support M	M	24 - 28
NHA485 3	McDavid A485 thermal tennis elbow support L	L	28 - 30.5
NHA485 4	McDavid A485 thermal tennis elbow support XL	XL	30.5 - 35.5

Measure elbow circumference.



Rolyan Takeoff Forearm Band

- Removable gel pad helps dampen vibration at the elbow
- TensoWrap™ forearm band changes force's direction to bypass the injured portion of the muscle/tendon unit
- Rinse after use to extend band life.
- Latex free

✓ DVA: RAP# AR03 (all codes) For more information please refer to pg 7.

Code	Description	Size
A808460	Rolyan Takeoff forearm band	Universal



Oppo 3089 Arm Sling

- Supports the arm and carries the weight across the back and shoulder
- Universal design fits right or left arm
- Adjustable slide buckle for proper height adjustment
- Comfortable lightweight material

✓ DVA: RAP# AR03 (all codes) For more information please refer to pg 7.

Code	Description	Size	(cm)
OPP3089 1	Oppo 3089 arm sling S	S	25.4 - 29.2
OPP3089 2	Oppo 3089 arm sling M	M	29.2 - 36.8
OPP3089 3	Oppo 3089 arm sling L	L	36.8 - 43.2
OPP3089 4	Oppo 3089 arm sling XL	XL	43.2 - 48.3

Measure the length of forearm.



Rolyan Envelope Arm Sling

- Designed for easy application and adjustment with an extra deep pocket to improve arm positioning
- The strap carries the weight of the arm across the back and shoulder for greater comfort
- Supports forearm and wrist
- Adjustable strap with hook and loop fasteners

✓ DVA: RAP# AR03 (all codes) For more information please refer to pg 7.

Code	Description	Size	(cm)
A8621	Rolyan envelope arm sling S	S	28
A8622	Rolyan envelope arm sling M	M	36
A8623	Rolyan envelope arm sling L	L	43
A8624	Rolyan envelope arm sling XL	XL	51

Measure the length of the forearm from the elbow to the knuckles.



Oppo 3289 Mesh Arm Sling

- Offers immobilisation and support for mild sprains/strains of the shoulder area
- Netting material for greater comfort, particularly for long-term use
- Helps keep shoulder and arm in a neutral position
- Adjustable padded straps for height adjustment
- Thumb loop helps keep hand correctly positioned

✓ DVA: RAP# AR03 (all codes) For more information please refer to pg 7.

Code	Description	Size	(cm)
OPP3289 1	Oppo 3289 mesh arm sling S	S	23.5 - 25.4
OPP3289 2	Oppo 3289 mesh arm sling M	M	25.4 - 30.5
OPP3289 3	Oppo 3289 mesh arm sling L	L	30.5 - 35.6
OPP3289 4	Oppo 3289 mesh arm sling XL	XL	35.5 - 40.6

Measure the length of forearm.



Oppo 3189 Arm Sling/Immobiliser

- Helps immobilise and support the arm
- Used to comfortably support a sprained or broken arm or for post-surgical support
- Extra strap offers more stabilisation to the arm and body

✓ DVA: RAP# AR03 (all codes) For more information please refer to pg 7.

Code	Description	Size	(cm)
OPP3189 1	Oppo 3189 arm sling/immobiliser S	S	25.4 - 29.2
OPP3189 2	Oppo 3189 arm sling/immobiliser M	M	29.2 - 36.8
OPP3189 3	Oppo 3189 arm sling/immobiliser L	L	36.8 - 43.2
OPP3189 4	Oppo 3189 arm sling/immobiliser XL	XL	43.2 - 48.3

Measure the length of forearm.



Rolyan Deluxe Shoulder Immobiliser

- Shoulder pad for added comfort
- Extra-deep pocket improves arm positioning
- Waist strap limits shoulder movement

✓ DVA: RAP# AR03 (all codes) For more information please refer to pg 7.

Code	Size	(cm)
A545800	XS	Up to 28
A545801	S	28
A545802	M	36
A545803	L	43
A545804	XL	51

Measure the length of the forearm from the elbow to the knuckles.



Oppo 4187 Soft Foam Arm Sling/Immobiliser

- Supports the forearm and shoulder
- Soft foam provides comfortable support and ventilation
- Double buckle design for easy adjustment
- Universal fits left and right by reversing the strap

✓ DVA: RAP# AR03 (all codes) For more information please refer to pg 7.

Code	Description	Size
OPP4187	Oppo 4187 soft foam arm sling/immobiliser	Universal size

- Adjustable padded strap, easy on the neck
- Strong hook and loop fastener design prevents slipping



Collarcare Light Arm Sling/Immobiliser

- Designed to provide support to the clavicle area or for full shoulder immobilisation
- Suitable for CVA patients
- 'O' buckle design allows adjustment for comfort
- Circumferential waist strap allowing arm to be fixed to the body

✓ DVA: RAP# AR03 (all codes) For more information please refer to pg 7.

Code	Description	Size	(cm)
SM040	Collarcare Light arm sling/immobiliser	S	16 x 32
SM050	Collarcare Light arm sling/immobiliser	M	19 x 39
SM060	Collarcare Light arm sling/immobiliser	L	21 x 44
SM070	Collarcare Light arm sling/immobiliser	XL	24 x 50

Sizing: depth x forearm length.



Collarcare Padded Arm Sling/Immobiliser

- Designed to provide support to the clavicle area or for full shoulder immobilisation
- Suitable for CVA patients
- The padded fabric provides superior body conformity and weight-bearing comfort
- 'D' buckle design allows adjustment for comfort
- Soft padded arm pouch can be folded to fit

✓ DVA: RAP# AR03 For more information please refer to pg 7.

Code	Description	Size	RAP #:
SM991	Collarcare padded arm sling/immobiliser	child	-
SM990	Collarcare padded arm sling/immobiliser	adult	AR03



Rolyan Shoulder Support Abduction Sling

- Provides shoulder abduction positioning with support
- Pillow portion rests on waist to support weight of arm
- Snap-open front panel facilitates putting support on and taking it off
- Y-tabs provide easy strap length adjustability
- Sling positioning allows air exchange at axilla, and breathable cotton fabric provides

✓ DVA: RAP# AR03 (all codes) For more information please refer to pg 7.

Code	Description	Size	(cm)
A54930	Rolyan shoulder support abduction sling S	S	28
A54931	Rolyan shoulder support abduction sling M	M	36
A54932	Rolyan shoulder support abduction sling L	L	43

Measure the length of the forearm from the elbow to the knuckles.

- Fits left and right
- For size, measure the length of the forearm from the elbow
- To the knuckles



Rolyan Figure Of 8 Sling

- Soft strapping system helps distribute pressure
- Supportive for orthopaedic and neurological conditions
- Hook and loop construction provides wide adjustability

✓ DVA: RAP# AR03 (all codes) For more information please refer to pg 7.

Code	Description	Size	(cm)
A5451	Rolyan figure-of-8 sling	S/M	Up to 34.5
A5452	Rolyan figure-of-8 sling	L/XL	Up to 37.5

Measure elbow crease to base of the index finger.



Rolyan CVA Sling

- Machine washable
- Latex free

✓ DVA: RAP# AR03 (all codes) For more information please refer to pg 7.

Code	Description	Size
A5492	Rolyan CVA sling	Universal

Measure elbow crease to base of the index finger.



Body Assist 250 Deluxe Wrist Support

- Compressive wrist brace
- Adjustable thumb strap

✓ DVA: RAP# AR03 (all codes) [For more information please refer to pg 7.](#)

Code	Description	Size	(cm)
NH250 1	Body Assist 250 deluxe wrist support	S	Up to 16.5
NH250 2	Body Assist 250 deluxe wrist support	M	16.5 - 19
NH250 3	Body Assist 250 deluxe wrist support	L	19 +

Measure wrist circumference.



McDavid A451 Thermal Wrist Wrap

- Multi-purpose wrist wrap providing therapeutic warmth, firm compression and some protection
- Thumb hole, fully adjustable
- Velcro closure
- Colour black
- One size fits all

✓ DVA: RAP# AR03 (all codes) [For more information please refer to pg 7.](#)

Code	Description	Size
NHA451	McDavid A451 thermal wrist wrap	Universal size



Oppo 1081 Wrist Wrap

- Helps relieve pain through pressure on injured wrists
- Adjustable hook and loop strap ensures comfortable fit and stabilisation during activities
- Provides firm support around weak or strained area

✓ DVA: RAP# AR03 (all codes) [For more information please refer to pg 7.](#)

Code	Description	Size	(cm)
OPP1081	Oppo 1081 wrist wrap	Universal size	12 - 23

Measure wrist circumference.



Oppo 1083 Wrist Wrap w/Thumb Loop

- Provides comfortable compression and support for weak or stressed wrists
- Helps treatment and prevention of injury
- Retains warmth, which may aid and speed up recovery period

✓ DVA: RAP# AR03 (all codes) [For more information please refer to pg 7.](#)

Code	Description	Size	(cm)
OPP1083	Oppo 1083 wrist wrap w/thumb loop	Universal size	12 - 23

Measure wrist circumference.



Oppo 2081 Wrist Wrap

- Helps relieve pain through pressure of injured wrists
- Elastic hook and loop strap insures comfortable fit and stabilisation during activities
- Provides firm support around weak or strained area

✓ DVA: RAP# AR03 (all codes) [For more information please refer to pg 7.](#)

Code	Description	Size	(cm)
OPP2081	Oppo 2081 wrist wrap	Universal size	13 - 23

Measure wrist circumference.



Oppo 2083 Wrist Wrap w/Thumb Loop

- Universal design fits left and right hand
- Provides comfortable compression and support

✓ DVA: RAP# AR03 (all codes) For more information please refer to pg 7.

Code	Description	Size	(cm)
OPP2083	Oppo 2083 wrist wrap w/thumb loop	Universal size	14 - 23

Measure wrist circumference.



Oppo 2481 Wrist Wrap w/Silicone

- Provides localised support and compression, and avoids unnecessary compression to areas where it is not required
- Tension is fully adjustable to provide from light support to total compression
- Cohesive fabric, causing no pain or irritation to the skin whilst in use, comfortable to wear and painless to remove

✓ DVA: RAP# AR03 (all codes) For more information please refer to pg 7.

Code	Description
OPP2481	Oppo 2481 wrist wrap w/silicone

Measure wrist circumference.

- 7.5cm width
- Secure the hook closure



Oppo 1082 Wrist Splint

- Provides compression for weak or overstressed wrists
- Spoon stay can be removed as healing progresses
- Stay can be relocated to fit either left or right hand

✓ DVA: RAP# AR03 (all codes) For more information please refer to pg 7.

Code	Description	Size	(cm)
OPP1082 1	Oppo 1082 wrist splint S	S	14 - 15.9
OPP1082 2	Oppo 1082 wrist splint M	M	15.9 - 18.4
OPP1082 3	Oppo 1082 wrist splint L	L	18.4 - 21
OPP1082 4	Oppo 1082 wrist splint XL	XL	21 - 23.5

Measure wrist circumference.



Oppo 2288 Wrist Splint With Strap

- Semi-rigid thumb spica portion is contoured to provide support, immobilisation and thumb abduction
- Provides wrist stability with moderate motion restriction
- An elastic wrist strap gives greater wrist stability
- Aluminum stay can easily be reversed to fit right or left hand

✓ DVA: RAP# AR03 (all codes) For more information please refer to pg 7.

Code	Description	Size	(cm)
OPP2288 1	Oppo 2288 wrist splint with strap S	S	14 - 15.9
OPP2288 2	Oppo 2288 wrist splint with strap M	M	15.9 - 18.4
OPP2288 3	Oppo 2288 wrist splint with strap L	L	18.4 - 21
OPP2288 4	Oppo 2288 wrist splint with strap XL	XL	21 - 23.5

Measure wrist circumference.



Oppo 3082 Wrist Support With D-Rings

- Hook and loop closures assure proper fit and easy application
- Removable aluminum splint helps relieve pain

✓ DVA: RAP# AR03 (all codes) For more information please refer to pg 7.

Code	Description	Size	(cm)
OPP3082 1	Oppo 3082 wrist support with D-rings	S	14 - 15.9
OPP3082 2	Oppo 3082 wrist support with D-rings	M	15.9 - 18.4
OPP3082 3	Oppo 3082 wrist splint with strap L	L	18.4 - 21
OPP3082 4	Oppo 3082 wrist splint with strap XL	XL	21 - 23.5

Measure wrist circumference.



Oppo 2182 Wrist Splint With Strap

- An elastic wrist strap gives greater wrist stability
- Reversible aluminum splint may be easily be relocated to fit right or left hand

✓ DVA: RAP# AR03 (all codes) For more information please refer to pg 7.

Code	Description	Size	(cm)
OPP2182 1	Oppo 2182 wrist splint with strap S	S	14 - 15.9
OPP2182 2	Oppo 2182 wrist splint with strap M	M	15.9 - 18.4
OPP2182 3	Oppo 2182 wrist splint with strap L	L	18.4 - 21
OPP2182 4	Oppo 2182 wrist splint with strap XL	XL	21 - 23.5

Measure wrist circumference.



Oppo 4088 Exolite Wrist Brace

- Radial & ulnar styloid relief
- Extra room at the base of the thumb, the palmar crease and 5th MP
- Lightweight for greater patient compliance
- Left or right

✓ DVA: RAP# AR03 (all codes) For more information please refer to pg 7.

Code	Description	Size	(cm)
OPP4088 1	Oppo 4088 Exolite wrist brace S	S	13 - 16.5
OPP4088 2	Oppo 4088 Exolite wrist brace M	M	17 - 19.5
OPP4088 3	Oppo 4088 Exolite wrist brace L	L	20 - 25.5

Measure wrist circumference.



Body Assist 260 Deluxe Wrist/Hand Brace

- Contoured support for weak, injured wrists
- Pliable rigid splint to minimise wrist movement

✓ DVA: RAP# AR03 (all codes) For more information please refer to pg 7.

Code	Description	Size	(cm)
NH260 1	Body Assist 260 deluxe wrist/hand brace S	S	Up to 16.5
NH260 2	Body Assist 260 deluxe wrist/hand brace M	M	16.5 - 19
NH260 3	Body Assist 260 deluxe wrist/hand brace L	L	19 - 21.5
NH260 4	Body Assist 260 deluxe wrist/hand brace XL	XL	22 +

Measure wrist circumference.



McDavid A454 Thermal Carpal Tunnel Wrist Splint

- Contoured thermal neoprene for weak injured wrists
- Includes a plantar splint to minimise wrist movement
- Specify left or right
- One size fits all

✓ DVA: RAP# AR03 (all codes) For more information please refer to pg 7.

Code - left	Code - right	Description
NHA454L	NHA454R	McDavid A454 thermal carpal tunnel wrist splint

Measure wrist circumference.



Rehband 4024 Manu Rheuma Flex Wrist

- Wrist support made of soft, skincaring and breathable material
- Supports the wrist through a flexible palmar splint
- Velcro closure simplifies applying the support for rheumatic patients
- A soft and pre-shaped plastic splint provides light support
- Straight model to fit the arthritic hand

✓ DVA: RAP# AR03 (all codes) For more information please refer to pg 7.

Code - left	Code - right	Size	(cm)
REH4024L XS	REH4024R XS	XS	14 - 15
REH4024L S	REH4024R S	S	15 - 16.5
REH4024L M	REH4024R M	M	16.5 - 18
REH4024L L	REH4024R L	L	18 - 19.5
REH4024L XL	REH4024R XL	XL	19.5 - 21
REH4024L XXL	REH4024R XXL	XXL	21 - 22.5

Measure wrist circumference.



Rehband 4055 Manu Comfort T Wrist

- Stabilising wrist brace
- Easily applied
- Excellent comfort through the temperature regulating features of ComforTemp
- Includes plastic and steel splints
- 3cm shorter than REH4058

✓ DVA: RAP# AR03 (all codes) For more information please refer to pg 7.

Code - left (L)	Code - right (R)	Size	(cm)
REH4055L 1	REH4055R 1	XS - S	13 - 16
REH4055L 2	REH4055R 2	M - L	16 - 19
REH4055L 3	REH4055R 3	XL - XXL	19 - 23

Measure wrist circumference.



Rehband 4058 Manu Comfort T Stable Wrist

- Extra stabilising wrist brace
- Easily applied
- Excellent comfort through the temperature regulating features of ComforTemp
- Includes plastic and steel splints
- 3cm longer than REH4055

✓ DVA: RAP# AR03 (all codes) For more information please refer to pg 7.

Code - left	Code - right	Size	(cm)
REH4058L 1	REH4058R 1	XS - S	13 - 16
REH4058L 2	REH4058R 2	M - L	16 - 19
REH4058L 3	REH4058R 3	XL - XXL	19 - 23

Measure wrist circumference.



Rehband 4062 Manuell EQ Wrist Support

- Long - lasting and dirt-repelling material
- Plastic splint
- Closed thumb grip
- Pain relieving and unloading effects
- May be used with #401 stabilising strap

✓ DVA: RAP# AR03 (all codes) For more information please refer to pg 7.

Code - left (L)	Code - right (R)	Size	(cm)
REH4062L XS	REH4062R XS	XS	14 - 15
REH4062L S	REH4062R S	S	15 - 16.5
REH4062L M	REH4062R M	M	16.5 - 18
REH4062L L	REH4062R L	L	18 - 19.5
REH4062L XL	REH4062R XL	XL	19.5 - 21
REH4062L XXL	REH4062R XXL	XXL	21 - 22.5

Measure wrist circumference.



Rehband 4063 Rheuma Manuell EQ Wrist Support

- Stabilising wrist brace
- Durable and dirt-repelling material
- Adjustable thumb grip
- Includes plastic splint

✓ DVA: RAP# AR03 (all codes) For more information please refer to pg 7.

Code - left (L)	Code - right (R)	Size	(cm)
REH4063L XS	REH4063R XS	XS	14 - 15
REH4063L S	REH4063R S	S	15 - 16.5
REH4063L M	REH4063R M	M	16.5 - 18
REH4063L L	REH4063R L	L	18 - 19.5
REH4063L XL	REH4063R XL	XL	19.5 - 21
REH4063L XXL	REH4063R XXL	XXL	21 - 22.5

Measure wrist circumference.

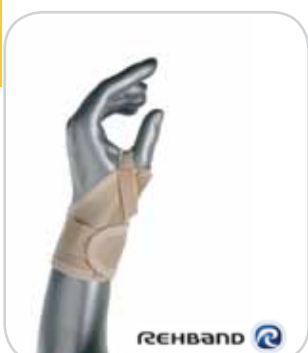

Rehband 4074 Diagonal Lycra Short Wrist

- A thumb support with splint to stabilise the CMC and MCP joints of the thumb
- The material offers optimal fit and comfort
- Pain relieving and unloading effects

✓ DVA: RAP# AR03 (all codes) For more information please refer to pg 7.

Code - left (L)	Code - right (R)	Size	(cm)
REH4074L XS	REH4074R XS	XS	13 - 14
REH4074L S	REH4074R S	S	14 - 16
REH4074L M	REH4074R M	M	16 - 18
REH4074L L	REH4074R L	L	18 - 20
REH4074L XL	REH4074R XL	XL	20 - 22

Measure wrist circumference.



Rehband 4088 Wristform

- Provides exceptional stability while immobilizing the wrist
- Made of thermoprene material for optimal comfort
- A firm wrist stay supports the palmar side, while a dorsal pocket holds a thermoplastic insert
- Both the stay and insert can be heat-moulded

✓ DVA: RAP# AR03 (all codes) For more information please refer to pg 7.

Code - left	Code - right	Size	(cm)
REH4088L S	REH4088R S	S	14 - 16
REH4088L M	REH4088R M	M	16 - 18
REH4088L L	REH4088R L	L	8 - 20
REH4088L XL	REH4088R XL	XL	20 - 22

Measure wrist circumference.



Rehband 4142 Manu 3D

- High quality 3 tab wrist brace with flexion stay
- Provides a light support to the basal thumb joint

✓ DVA: RAP# AR03 (all codes) For more information please refer to pg 7.

Code - left	Code - right	Size	(cm)
REH4142L XS	REH4142R XS	XS	14.5 - 15.5
REH4142L S	REH4142R S	S	15.5 - 16
REH4142L M	REH4142R M	M	16 - 17
REH4142L L	REH4142R L	L	17 - 18
REH4142L XL	REH4142R XL	XL	18 - 19
REH4142L XXL	REH4142R XXL	XXL	19 - 20

Measure wrist circumference.



Rehband 4143 Manu 3D Basis

- High quality 3 tab wrist brace with flexion stay
- Allows free thumb motion
- Six sizes left and right

✓ DVA: RAP# AR03 (all codes) For more information please refer to pg 7.

Code - left	Code - right	Size	(cm)
REH4143L XS	REH4143R XS	XS	14.5 - 15.5
REH4143L S	REH4143R S	S	15.5 - 16
REH4143L M	REH4143R M	M	16 - 17
REH4143L L	REH4143R L	L	17 - 18
REH4143L XL	REH4143R XL	XL	18 - 19
REH4143L XXL	REH4143R XXL	XXL	19 - 20

Measure wrist circumference.



Rehband 7110 Wrist Support

- Warming neoprene stabilising wrist support
- The aluminium splint supplied can be replaced by a pre-shaped plastic splint

✓ DVA: RAP# AR03 (all codes) For more information please refer to pg 7.

Code - left	Code - right	Size	(cm)
REH7110L XS	REH7110R XS	XS	13 - 14
REH7110L S	REH7110R S	S	14 - 16
REH7110L M	REH7110R M	M	16 - 18
REH7110L L	REH7110R L	L	18 - 20
REH7110L XL	REH7110R XL	XL	20 - 22

Measure wrist circumference.



Rolyan D-Ring Wrist Long Fit - Firm

- Volar and dorsal stays for extra wrist support
- Prevents unwanted flexion or extension, yet allows unobstructed motion of the fingers and thumb
- Non-elastic circumferential design for easy application and for firm, evenly distributed pressure without restricting circulation

✓ DVA: RAP# AR03 (all codes) For more information please refer to pg 7.

Code - left	Code - right	Size	(cm)
A600301	A600300	XS	Up to 14.6
A600303	A600302	S	14.6 - 16.5
A600305	A600304	M	16.6 - 19.1
A600307	A600306	L	16.6 - 19.1

Measure wrist circumference.

- D-ring closure system for simple application, removal and customized tension control
- Double layer of stockinette under closures cushions straps



Rolyan D-Ring Wrist Brace

- Non-elastic construction does not restrict circulation
- Circumferential design holds the brace in position during application
- D-ring closures provide tension control to adjust amount of support
- Double layer of cotton stockinette under closures cushions straps
- Forearm length is proportional to brace size
- Removable, adjustable aluminium support bar
- Splints available in regular (A611) and long (A915) length
- Regular length splint is also available with a larger thumb hole (A61110), which accommodates larger thumbs and fluctuating oedema.
- Fabricated from a polyester/cotton fabric laminated to 1cm foam

✓ DVA: RAP# AR03 (all codes) For more information please refer to pg 7.

Code - left	Code - Right	Size	(cm)	Length
A611L XS	A611R XS	XS	Up to 14.6	15.9
A611L S	A611R S	S	14.6 - 16.5	16.5
A611L M	A611R M	M	16.6 - 19.1	17.8
A611L L	A611R L	L	19.2 - 21.6	19
A611L XL	A611R XL	XL	Over 21.6	19.7

Larger thumb opening

A611101	A611100 XS	XS	Up to 14.6	15.9
A611103	A611102 S	S	14.6 - 16.5	16.5
A611105	A611104 M	M	16.6 - 19.1	17.8
A611107	A611106 L	L	19.2 - 21.6	19
A611109	A611108 XL	XL	Over 21.6	19.7

Long Fit

A915L XS	A915R XS	XS	Up to 14.6	21
A915L S	A915R S	S	14.6 - 16.5	21.6
A915L M	A915R M	M	16.6 - 19.1	22.2
A915L L	A915R L	L	19.2 - 21.6	22.6
A915L XL	A915R XL	XL	Over 21.6	23.2

Measure wrist circumference.



Rolyan Wrist Support

- Creep resistant elastic which prevents bunching that can restrict circulation
- Anatomical design provides superior comfort and function and the two piece design assures optimal fit
- Includes a removable adjustable stay
- Hand or machine wash, air dry

✓ DVA: RAP# AR03 (all codes) For more information please refer to pg 7.

Code - left	Code - right	Size	(cm)
A619063	A619062	S	14 - 16.5
A619065	A619064	M	16.6 - 18.4
A619067	A619066	L	18.5 - 20.3
A619069	A619068	XL	20.4 - 22.2

Measure wrist circumference.



Rolyan Take Off Universal Wrist Splint

- Semi-rigid foam support with plastic stay
- Soft, breathable Fabrifoam material provides friction to keep splint from migrating and helps remove moisture
- One size fits most adults

✓ DVA: RAP# AR03 (all codes) For more information please refer to pg 7.

Code - left	Code - right	Size
A919801	A919800	universal



Rolyan Alignrite Wrist Support w/Wrist Strap

- Provides excellent support for the wrist while allowing fingers and thumb free movement
- Woven cotton-coated rubber fabric has open weave for ventilation
- Wrap - around wrist strap provides extra support
- Hand or machine wash, air dry
- Latex free

✓ DVA: RAP# AR03 (all codes) For more information please refer to pg 7.

Code - left	Code - right	Size	(cm)
A619001	A619002	XS	11.4 - 14.0
A619003	A619004	S	14.0 - 16.5
A619005	A619006	M	16.6 - 18.4
A619007	A619008	L	18.5 - 20.3
A619009	A619010	XL	20.4 - 22.2

Measure wrist circumference.



Rolyan Wrist Splint

- Unlike neoprene or perforated neoprene, breathoprene allows air through, and wicks perspiration away from the skin for enhanced comfort and compliance
- The two-way stretch 3.2mm thick, soft material provides compression and a perfect fit
- Removable metal dorsal and palmar stays and wrist D-ring strap for added support

✓ DVA: RAP# AR03 (all codes) For more information please refer to pg 7.

Code - left	Code - right	Size	(cm)
DM45101	DM45102	S	14 - 16.5
DM45103	DM45104	M	16.6 - 18.4
DM45105	DM45106	L	18.5 - 20.3
DM45107	DM45108	XL	20.4 - 22.2

Measure wrist circumference.

- Wraparound design
- Latex free



Oppo 1289 Wrist/Thumb Support w/Strap

- Three removable metal splints in thumb area for improved stability
- Additional strap for stabilisation during activities
- Supports the wrist and thumb, leaving the palm free
- Ideal for sprains of thumb, ligament support, and minor fractures of the thumb

✓ DVA: RAP# AR03 (all codes) For more information please refer to pg 7.

Code	Description	Size	(cm)
OPP1289 1	Oppo 1289 wrist/thumb support w/strap S	S	13 - 15.2
OPP1289 2	Oppo 1289 wrist/thumb support w/strap M	M	15.2 - 17.2
OPP1289 3	Oppo 1289 wrist/thumb support w/strap L	L	17.2 - 19.1
OPP1289 4	Oppo 1289 wrist/thumb support w/strap XL	XL	19.1 - 21

Measure wrist circumference.



Oppo 2184 Wrist/Thumb Sleeve

- Pull-on sleeve in four-way stretch tubular elastic
- Not splinted, light compression
- Universal design fits left and right hand

✓ DVA: RAP# AR03 (all codes) For more information please refer to pg 7.

Code	Description	Size	(cm)
OPP2184 1	Oppo 2184 wrist/ thumb sleeve S	S	14 - 15.9
OPP2184 2	Oppo 2184 wrist/ thumb sleeve M	M	15.9 - 18.4
OPP2184 3	Oppo 2184 wrist/ thumb sleeve L	L	18.4 - 21
OPP2184 4	Oppo 2184 wrist/ thumb sleeve XL	XL	21 - 23.5

Measure wrist circumference.



Oppo 3182 Wrist Support With Thumb

- Wraparound design and hook and loop straps for easy fit.
- Supports and limits the motion of the thumb and wrist joint
- Elastic fabric provides compression.
- Elastic hook and loop strap may be used to limit wrist motion

✓ DVA: RAP# AR03 (all codes) For more information please refer to pg 7.

Code	Description	Size	(cm)
OPP3182 1	Oppo 3182 wrist support with thumb	S	14 - 15.9
OPP3182 2	Oppo 3182 wrist/ thumb sleeve	M	15.9 - 18.4
OPP3182 3	Oppo 3182 wrist/ thumb sleeve	L	18.4 - 21
OPP3182 4	Oppo 3182 wrist/ thumb sleeve	XL	21 - 23.5

Measure wrist circumference.



Oppo 1089 Wrist Thumb Support

- Thumb orthosis especially suitable for rheumatics
- Relieves pain and stabilises CMC joint
- Reinforced metal stick stabilises thumb
- Adjustable hook and loop fasteners insure comfortable fit and stabilisation during activities
- Thermal wrist support for tenosynovitis, carpal tunnel syndrome and general wrist support

✓ DVA: RAP# AR03 (all codes) For more information please refer to pg 7.

Code	Description	Size	(cm)
OPP1089 1	Oppo 1089 wrist thumb support	S	14 - 15.9
OPP1089 2	Oppo 1089 wrist thumb support	M	15.9 - 18.4
OPP1089 3	Oppo 1089 wrist thumb support	L	18.4 - 21
OPP1089 4	Oppo 1089 wrist thumb support	XL	21 - 23.5

Measure wrist circumference.



Oppo 1188 Mouldable Wrist/Thumb Support

- Relieves pain and stabilises thumb
- Thermoplastic support stabilises thumb
- Thermoplastic insert may be removed as healing progresses
- Available in 3 lengths (14cm, 16.5cm (pictured) and 21cm)

✓ DVA: RAP# AR03 (all codes) For more information please refer to pg 7.

Code - Short 14cm	Code - Medium 16.5cm	Long 21cm	Size	(cm)
OPP1188 - 5 1	OPP1188 - 6 1	OPP1188 - 8 1	S	14 - 15.9
OPP1188 - 5 2	OPP1188 - 6 2	OPP1188 - 8 2	M	15.9 - 18.4
OPP1188 - 5 3	OPP1188 - 6 3	OPP1188 - 8 3	L	18.4 - 21
OPP1188 - 5 4	OPP1188 - 6 4	OPP1188 - 8 4	XL	21 - 23.5
OPP1188 - 5 5	OPP1188 - 6 5	OPP1188 - 8 5	XXL	23.5 - 26

Measure wrist circumference.



Rehband 4025 Rheuma Wrist & Thumb Support

- Wrist/thumb support made of soft, skincaring and breathable material
- Supports the wrist through a flexible palmar splint
- Velcro closure simplifies applying the support for rheumatic patients
- Straight model to fit the arthritic hand
- The placement of the velcro is chosen to avoid any pressure on caput ulnae

✓ DVA: RAP# AR03 (all codes) For more information please refer to pg 7.

Code - left (L)	Code - right (R)	Size	(cm)
REH4025L XS	REH4025R XS	XS	14 - 15
REH4025L S	REH4025R S	S	15 - 16.5
REH4025L M	REH4025R M	M	16.5 - 18
REH4025L L	REH4025R L	L	18 - 19.5
REH4025L XL	REH4025R XL	XL	19.5 - 21
REH4025L XXL	REH4025R XXL	XXL	21 - 22.5

Measure wrist circumference.



Rehband 4146 Manu 3D Pollex

- High quality 3 tab wrist brace with flexion stay
- Aluminium thumb stay
- Six sizes left and right

✓ DVA: RAP# AR03 (all codes) For more information please refer to pg 7.

Code - left (L)	Code - right (R)	Size	(cm)
REH4146L XS	REH4146R XS	XS	14 - 15
REH4146L S	REH4146R S	S	15.5 - 16
REH4146L M	REH4146R M	M	16 - 17
REH4146L L	REH4146R L	L	17 - 18
REH4146L XL	REH4146R XL	XL	18 - 19
REH4146L XXL	REH4146R XXL	XXL	19 - 20

Measure wrist circumference.



Rolyan D-Ring Wrist/Thumb Spica

- Made of cotton/polyester fabric lined with cotton stockinette
- Circumferential design with D-ring closures makes the brace easy to put on and comfortable to wear
- Two metal stays support wrist and thumb

✓ DVA: RAP# AR03 (all codes) For more information please refer to pg 7.

Code - left (L)	Code - right (R)	Size	(cm)
A615 1	A615 2	XS	Upt to 14.6
A615 3	A615 4	S	14.6 - 16.5
A615 5	A615 6	M	16.6 - 19.1
A615 7	A615 8	L	19.2 - 21.6
A615 9	A615 10	XL	Over 21.6

Measure wrist circumference.



Rolyan D-Ring Wrist/Thumb Spica - Thermal

- Made from a neoprene blend with a Trioxon lining
- Maintains body heat, yet allows skin to breathe
- Circumferential design with D-ring closures makes the brace easy to put on and comfortable to wear
- Adjust the amount of wrist extension with aluminium stay

✓ DVA: RAP# AR03 (all codes) For more information please refer to pg 7.

Code - left (L)	Code - right (R)	Size	(cm)
A6151 1	A6151 2	XS	U to 14.6
A6151 3	A6151 4	S	14.6 - 16.5
A6151 5	A6151 6	M	16.6 - 19.1
A6151 7	A6151 8	L	19.2 - 21.6
A6151 9	A6151 20	XL	Over 21.6

Measure wrist circumference.



Body Assist N29 Thumb Abduction Splint

- Minimises thumb movement while leaving palm and fingers free

DVA: RAP# AR03 (all codes) For more information please refer to pg 7.

Code	Description	Size	(cm)
NHN29 1	Body Assist N29 thumb abduction splint	S/M	Up to 19
NHN29 3	Body Assist N29 thumb abduction splint	L/XL	19 +

Measure wrist circumference.



Body Assist 280 Thumb Splint

- Designed to minimise wrist and thumb movement
- Supplied with two interchangeable splints - a rigid splint, and pliable metal stay

DVA: RAP# AR03 (all codes) For more information please refer to pg 7.

Code	Description	Size	(cm)
NH280 1	Body Assist 280 thumb splint	S	Up to 16.5
NH280 2	Body Assist 280 thumb splint	M	16.5 - 19
NH280 3	Body Assist 280 thumb splint	L	19 - 21.5
NH280 4	Body Assist 280 thumb splint	XL	22+

Measure wrist circumference.



Rehband 4064 EQ Diagonal Lycra Thumb

- A thumb support made of durable lycra
- Has a splint to stabilise the CMC and MCP joints of the thumb
- The elasticity of the material is used diagonally for optimal fit and support

DVA: RAP# AR03 (all codes) For more information please refer to pg 7.

Code - left (L)	Code - right (R)	Size	(cm)
REH4064L XS	REH4064R XS	XS	13 - 14
REH4064L S	REH4064R S	S	14 - 16
REH4064L M	REH4064R M	M	16 - 18
REH4064L L	REH4064R L	L	18 - 20
REH4064L XL	REH4064R XL	XL	20 - 22

Measure wrist circumference.



Rehband Thumboform Splint

DVA: RAP# AR03 (all codes) For more information please refer to pg 7.

Code - Short		Code - Long		Code - XLong		Size	(cm)
Left	Right	Left	Right	Left	Right		
REH4084L S	REH4084R S	REH4085L S	REH4085R S	REH4086L S	REH4086R S	S	14 - 16
REH4084L M	REH4084R M	REH4085L M	REH4085R M	REH4086L M	REH4086R M	M	16 - 18
REH4084L L	REH4084R L	REH4085L L	REH4085R L	REH4086L L	REH4086R L	L	18 - 20

Measure wrist circumference.

- The thumboform thumb support comes with a heat-mouldable insert
- This splint stabilises the CMC and MCP joint of the thumb
- Also available in XS and XL
- Available in short (4084), long (4085) and X/long (4086) styles



Rolyan Collum CMC Thumb Brace

DVA: RAP# AR03 (all codes) For more information please refer to pg 7.

- Made of quality leather with a soft suede lining for comfort and durability
- Restricts extremes of motion in the thumb joint
- While allowing the user to perform routine hand functions
- The support fits over the thumb and wraps around the wrist

Code - left (L)	Code - right (R)	Size	(cm)
A920L XS	A920R XS	XS	Up to 9.5
A920L S	A920R S	S	9.8 - 10.8
A920L M	A920R M	M	11.1 - 12.1
A920L L	A920R L	L	over 12.4

Measure length from the top thumb-joint, along outside of thumb to the wrist-bone.

- It is held in place with two hook and loop fasteners



Rolyan Gel Thumb Spica Splint

- Cushions and helps protect the thumb.
- Gel shell pad provides gentle pressure on the incision site to help reduce scar formation and hypersensitivity
- Optional polyform stay along radial side of thumb provides additional support to the thumb

✓ DVA: RAP# AR03 (all codes) For more information please refer to pg 7.

Code - left (L)	Code - right (R)	Size	(cm)
A599001	A599002	XS	Up to 9.5
A599003	A599004	S	9.5 - 10.8
A599005	A599006	M	10.9 - 12
A599007	A599008	L	over 12.1

Measure length from the top thumb - joint, along outside of thumb to the wrist-bone.



Rolyan Take Off Thumb Splint

- Made using fabric NuStimWrap
- The splint is available with either a standard plastic thumb stay for increased support, or a mouldable stay for custom fit
- Provides warmth, compression and support to reduce pain
- Easy to apply over joints and helps prevent overuse
- One size fits most

✓ DVA: RAP# AR03 (all codes) For more information please refer to pg 7.

Code - left (L)	Code - right (R)	Style
A952713	A952712	Regular
A952701	A952700	With Mouldable Insert



Rolyan Thermo-Form Thumb Splint

- These splints contain a pocket on the inside where the thermoplastic piece is inserted.
- The thermoplastic material can be moulded directly in the pocket by pouring in hot water
- The thermoplastic material becomes mouldable in approx. 1 minute, allowing the therapist to mould the splint to the thumb for proper positioning
- The splint comes with one strap

✓ DVA: RAP# AR03 (all codes) For more information please refer to pg 7.

Code - left (L)	Code - right (R)	Size	(cm)
C55006101	C55006102	XS	Up to 14
C55006103	C55006104	S	14 - 16.5
C55006105	C55006106	M	16.5 - 19.1
C55006107	C55006108	L	19.1 - 21.6
C55006109	C550061010	XL	21.6 - 23

Measure wrist circumference.



Rolyan Action Thumsling

- Four-way stretch material conforms in the palm without adding bulk
- Reduces CMC subluxation and pain without limiting wrist or thumb motion
- The sling strap supports the thumb and assists in maintaining web space to reduce CMC subluxation

✓ DVA: RAP# AR03 (all codes) For more information please refer to pg 7.

Code - left (L)	Code - right (R)	Size	(cm)
3P - P2006 - L23	3P - P2006 - R23	S/M	15.0 - 18.4
3P - P2006 - L34	3P - P2006 - R34	M/L	18.5 - 23.5

Measure circumference at MP's.



Rolyan Polycentric Hinged Ulnar Deviation Splint

- This splint leaves the palm free for gripping objects
- The polycentric hinge allows full flexion and extension of the fingers
- Padded finger stays are malleable for ease of application and to provide optimal alignment
- Ideal for use following MP arthroplasty

✓ DVA: RAP# AR03 (all codes) For more information please refer to pg 7.

Code - left (L)	Code - right (R)	Size	(cm)
3P - P2002 - L1	3P - P2002 - R1	XS	5.7 - 7
3P - P2002 - L2	3P - P2002 - R2	S	7 - 7.6
3P - P2002 - L3	3P - P2002 - R3	M	7.6 - 8.6
3P - P2002 - L4	3P - P2002 - R4	L	8.6 - 9.2

Measure width from the 2nd to 5th MP to size.



Rolyan Radial Hinged Deviation Splint

- Soft finger straps permit each finger to be individually aligned for maximum control
- Lined in soft felt, dorsal based splint leaves palm free for function

✓ DVA: RAP# AR03 (all codes) [For more information please refer to pg 7.](#)

Code - left (L)	Code - right (R)	Size	(cm)
3P - P2003 - L2	3P - P2003 - R2	S	7 - 7.6
3P - P2003 - L3	3P - P2003 - R3	M	7.6 - 8.6
3P - P2003 - L4	3P - P2003 - R4	L	8.6 - 9.2

Measure width from the 2nd to 5th MP to size.



Rolyan Comforter Splint

- The Comforter splint holds the wrist and MP joints of the fingers in neutral to reduce stress on muscles and tendons
- Malleable padded stays allow each finger to be individually aligned
- IP joints are free to allow the wearer to manage bedding and night time activities
- The softly padded cover is removable for washing

✓ DVA: RAP# AR03 (all codes) [For more information please refer to pg 7.](#)

Code - left (L)	Code - right (R)	Size	(cm)
3P - P3002 - L2	3P - P3002 - R2	S	7 - 7.6
3P - P3002 - L3	3P - P3002 - R3	M	7.6 - 8.6
3P - P3002 - L4	3P - P3002 - R4	L	8.6 - 9.2

Measure width from the 2nd to 5th MP to size.



Rolyan Hand-Based in-Line Splint

- MCP support straps have reinforced neoprene to prevent over-stretching caused by continual use
- Finger straps support each finger individually
- 2.4mm neoprene gives needed support without bulkiness
- Neoprene fabric retains warmth, increasing comfort

✓ DVA: RAP# AR03 (all codes) [For more information please refer to pg 7.](#)

Code - left (L)	Code - right (R)	Size	(cm)
A679111	A679112	XS	Up to 14.6
A679113	A679114	S	14.6 - 16.5
A679115	A679116	M	16.6 - 19.1
A679117	A679118	L	Over 19.1

Measure wrist circumference.



Finger Flexor Splint

- Aids flexion at the proximal and distal interphalangeal joints on an individual finger

✓ DVA: RAP# AR03 (all codes) [For more information please refer to pg 7.](#)

Code	Description	Size	Length
B2335 S	Finger flexor splint	S	child
B2335 M	Finger flexor splint	M	short
B2335 L	Finger flexor splint	L	long



Finger Extension Splint

- A dynamic extension splint which resists flexion of the interphalangeal joints and assists in their extension

✓ DVA: RAP# AR03 (all codes) [For more information please refer to pg 7.](#)

Code	Description	Size	Length
B2336 S	Finger extension splint	S	child
B2336 M	Finger extension splint	M	short
B2336 L	Finger extension splint	L	long



Oppo 4285 Finger Splint

- Lightweight aluminum protects injured finger
- Ventilated foam padding
- Folds over the end of the finger to provide protection and stabilisation

✓ DVA: RAP# AR03 (all codes) [For more information please refer to pg 7.](#)

Code	Description	Size	Length
OPP4285 1	Oppo 4285 Finger splint	S	5.5
OPP4285 2	Oppo 4285 Finger splint	M	7.5
OPP4285 3	Oppo 4285 Finger splint	L	9.5



Oppo 4280 Baseball Finger Splint

- Help stabilise the phalangeal joints in position
- Malleable aluminum splint can be reshaped to hold finger at an exact degree of flexion or extension
- Provides firm support while injury heals

✓ DVA: RAP# AR03 (all codes) [For more information please refer to pg 7.](#)

Code	Description	Size	Length
OPP4280 1	Oppo 4280 Baseball finger splint	S	8
OPP4280 2	Oppo 4280 Baseball finger splint	M	10
OPP4280 3	Oppo 4280 Baseball finger splint	L	12

Length of finger (cm).

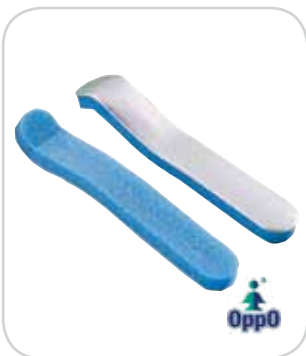

Oppo 4282 Curved Finger Splint

- Lined and padded with soft, ventilated material
- Curved finger splints support and protect dislocated fracture
- Upward curve at the tip to protect the end of the finger

✓ DVA: RAP# AR03 (all codes) [For more information please refer to pg 7.](#)

Code	Description	Size	Length
OPP4282 1	Oppo 4282 Curved finger splint	S	7
OPP4282 2	Oppo 4282 Curved finger splint	M	10
OPP4282 3	Oppo 4282 Curved finger splint	L	13

Length of finger (cm).



Oppo 4281 Frog Finger Splint

- Foam padding assures comfortable fit.
- Malleable aluminum splint folds to grip finger.
- Maintains interphalangeal joints in correct position

✓ DVA: RAP# AR03 (all codes) [For more information please refer to pg 7.](#)

Code	Description	Size	Length
OPP4281 1	Oppo 4281 Frog finger splint	S	6
OPP4281 2	Oppo 4281 Frog finger splint	M	7
OPP4281 3	Oppo 4281 Frog finger splint	L	8

Length of finger (cm).



Oppo 4283 Open Thimble Splint

- Malleable aluminum splint for immobilization of finger
- Protects and stabilises fractures of the distal finger joint
- Encloses finger injuries and protects on four sides

✓ DVA: RAP# AR03 (all codes) [For more information please refer to pg 7.](#)

Code	Description	Size	Length
OPP4283 1	Oppo 4283 Open thimble splint	S	5.5
OPP4283 2	Oppo 4283 Open thimble splint	M	6.5
OPP4283 3	Oppo 4283 Open thimble splint	L	7.5

Length of finger (cm).



Oppo 4182 Wrist/Hand Positioning Splint

- Two unstretchable straps give greater wrist stability
- Incorporating a molded metal palmar stay which is used to position the wrist and hand
- Insert each two fingers, except thumb, into the two unstretchable straps
- Be sure the metal stay is on palm side of hand, then wrap the strap over hand and secure snugly

✓ DVA: RAP# AR03 (all codes) [For more information please refer to pg 7.](#)

Code	Description	Size	Wrist (cm)
OPP4182S	OPPO 4182 wrist/hand positioning splint	S	13.1 - 17.1
OPP4182M	OPPO 4182 wrist/hand positioning splint	M	17.1 - 21.6
OPP4182 L	OPPO 4182 wrist/hand positioning splint	L	21.6 - 30.5

Measure wrist circumference.

- Thread through the buckles and secure the two hook and loop straps to desired compression



Rolyan Palm Protector With Finger Separator

- Made from closed-cell foam, lined with pile
- Soft finger separator strap weaves between fingers and can be cut to adjust fit
- Hand washable
- One size fits all

✓ DVA: RAP# AR03 (all codes) [For more information please refer to pg 7.](#)

Code - left	Code - right	Description
A81201	A81202	Rolyan palm protector with finger separator

Universal size, left and right.



Rolyan Palm Shield - Foam

- This foam support wraps around the user's wrist and hand and holds the thumb and fingers in place
- It is held in place with a Velcro closure at the wrist
- The support has four rounded foam sections that separate and position the fingers
- It also has a padded section that rests in the user's palm, and supports and positions the user's thumb

✓ DVA: RAP# AR03 (all codes) [For more information please refer to pg 7.](#)

Code - left	Code - right	Description
A812401	A812402	Rolyan palm shield - foam

Universal size, left and right.

- This hand support is designed for users with moderate to severe hand tightness
- One size fit most adults - left and right fittings



Rolyan Palm Shield-Sof-Gel

- A palm shield with gel which helps prevent skin breakdown in the palm and between the fingers
- Gel in finger separators and palm won't bottom out giving the product a longer life
- Ideal for moderate to severe hand tightness
- Helps prevent finger contractures

✓ DVA: RAP# AR03 (all codes) [For more information please refer to pg 7.](#)

Code - left	Code - right	Description
A812405	A812406	Rolyan palm shield - sof - gel

Universal size, left and right.



Rolyan Palm Protector

- Holds fingers out to prevent digging into the palm of the hand
- Cuff fabricated from closed-cell foam lined with a pile fabric
- Pre-rolled and attached to simplify application
- Hand wash, air dry
- One size for each of left and right hand

✓ DVA: RAP# AR03 (all codes) [For more information please refer to pg 7.](#)

Code - left	Code - right	Description
A812101	A812201	Rolyan palm protector

Universal size, left and right.



Rolyan Carve-It Hand Positioning Splint

- For use with strokes, Alzheimer's disease, dementia and other neurological impairments
- Helps anatomically position the hand with mild to moderate finger spasticity
- Design allows use with left and right hand
- Easy to modify by cutting foam with an electric knife for a custom fit

✓ DVA: RAP# AR03 (all codes) For more information please refer to pg 7.

(note: replacement parts are RAP #: AR27)

Splint Code	Replacement Cover Code	Size	(cm)
A812610	A812612	Sm/Med	Up to 7.6
A812611	A812613	Lge/XL	7.6 +

For size, measure width of 2nd to 5th MCP.

- Flat bottom provides easy positioning in bed or on lap tray, arm tray, etc
- Removable cover can be hand washed and air dried



Rolyan Progressive Palm Protector Splint (With Optional Wrist Support)

✓ DVA: RAP# AR03 (all codes) For more information please refer to pg 7.

Series	Foam Size (cm)	MCP Flexion	Palm Splint Code		Palm Splint with Wrist Support Code		Replacement Pads Code
			Left	Right	Left	Right	
1	2.5	90	A812313	A812314	A812301	A812302	A812307
2	5.1	60	A812315	A812316	A812303	A812304	A812309
2	7.6	30	A812317	A812318	A812305	A812306	A812311

Indications:

Series 1	Tight hands with moderate to severe spasticity or contractures
Series 2	Hands with mild to moderate spasticity or contractures
Series 3	Hands with mild spasticity or contractures, or non - spastic hands, to provide a functional position in a soft splint

- Progressive soft splint for neurological conditions and arthritis
- Adjust splint as condition improves by removing foam palm piece and replacing it with a larger series (see below)
- Variable strapping system allows strapping thumb only, fingers only, or both thumb and fingers
- Splint base is large enough to accommodate all hand sizes and can be modified for a smaller hand by trimming the edges
- Wrist support style has a removable Ezeform stay that can be moulded for wrist extension and D-ring attachments for secure fit
- Available in universal adult size
- Each splint comes with one foam palm piece
- Hand wash splint, air dry



Rolyan Kwik-Form Functional Resting Splint

✓ DVA: RAP# AR03 (all codes) For more information please refer to pg 7.

Splint Code		Replacement Cover Code		Size	(cm)
Left	Right	Left	Right		
A812701	A812700	A812705R	A812704R	Sm/Med	Up to 18
A812703	A812702	A812707R	A812706R	Med/Lge	18cm +

- Can be custom fitted without tools or heat - simply bend the wire core to the desired position
- Supports the wrist, thumb and fingers in a functional or resting position
- Features hook and loop closures and removable machine washable cover
- To determine size, measure wrist circumference



Rolyan Kwik-Form Progressive Hand Splint

✓ DVA: RAP# AR03 (all codes) For more information please refer to pg 7.

Splint Code	Replacement Cover Code	Size	(cm)
A812610	A812622R	Sm/Med	Up to 18
A812621	A812623R	Med/Lge	Up to 18+

- Can be custom fitted without tools or heat - simply bend the wire core to the desired position
- Supports the hand and wrist and provides progressive extension of the fingers
- Includes 3 hand rolls - as condition progresses, simply replace the hand roll
- For especially tight hands, can be used without hand roll
- Removable cover sewn from comfortable, cool soft material for maximum compliance
- Features hook and loop closures and removable machine washable cover
- To determine size, measure wrist circumference



Rolyan AirPro Air Graduate Splint

- Air Therapy-low load prolonged stretch
- Conforms to the shape of the hand accommodating different degrees of finger contracture
- Ideal for severely contracted fingers
- Removable cone shaped palmar air bladder can be used independently of wrist support
- Extra cover included
- Universal size

✓ DVA: RAP# AR03 (all codes) [For more information please refer to pg 7.](#)

Code - left	Code - right	Description
OC - AP31AGL	OC - AP31AGR	Rolyan AirPro air graduate splint

Universal size, left and right.



Rolyan SoftPro Functional Resting Hand

✓ DVA: RAP# AR03 (all codes) [For more information please refer to pg 7.](#)

Width: width of MP joints (cm). Length: wrist to finger tip (cm).

Left (L)	Right (R)	Size	Width	Length
OC - SP31FFR SL	OC - SP31FFR SR	Small	Up to 7.6	Up to 15.2
OC - SP31FFR ML	OC - SP31FFR MR	Medium	7.6 - 8.9	15.2 - 20.3
OC - SP31FFR LL	OC - SP31FFR LR	Large	8.9 - 10.2	20.3 - 24.1
OC - SP31FFR CL	OC - SP31FFR CR	Child	5 - 7.6	17.8
OC - SP31FFR YL	OC - SP31FFR YR	Youth	5 - 7.6	20.3

- Treats moderate contractures of the wrist/hand/fingers
- Easily adjustable for ulnar radial deviation
- Finger separator and ulnar drift strap available separately to allow custom fitting



Rolyan SoftPro Grip

✓ DVA: RAP# AR03 (all codes) [For more information please refer to pg 7.](#)

Width: width of MP joints (cm). Length: wrist to finger tip (cm). Order by small/left etc.

Left (L)	Right (R)	Size	Width	Length
OC - SP31FG SL	OC - SP31FG SR	Small	Up to 7.6	Up to 15.2
OC - SP31FG ML	OC - SP31FG MR	Medium	7.6 - 8.9	15.2 - 20.3
OC - SP31FG LL	OC - SP31FG LR	Large	8.9 - 10.2	20.3 - 24.1

- Treats moderate to severe contractures of the wrist/hand/fingers
- Easily moulded without tools yet sturdy enough to maintain shape during wear
- Finger separator and ulnar drift strap available separately to allow custom fitting
- Also available Child and Youth size



Rolyan SoftPro Finger Separator (Accessory To SoftPro Splint)

✓ DVA: RAP# AR03 (all codes) [For more information please refer to pg 7.](#)

Code	Description	Size
OC-SPFSS	Rolyan Softpro finger separator (accessory to SoftPro splint)	Universal

- For use with SoftPro Grip and SoftPro functional resting hand splints
- Provides finger separation and mild abduction
- Protects finger skin integrity
- Universal size



Rolyan SoftPro Ulnar Drift Strap (Accessory To SoftPro Splint)

✓ DVA APPROVED: RAP#: AR03 [For more information please refer to pg 7.](#)

Code	Description	Size
OC-SPFSU	Rolyan Softpro ulnar drift strap (accessory to SoftPro splint)	Universal

- For use with SoftPro Grip and SoftPro functional resting hand splints
- Holds fingers in comfortable, neutral position



Cosmac Cock-Up Resting Hand Splint

- Pre-shaped plastic with velcro fastening straps
- Use for carpal tunnel syndrome, RSI, resting splint

✓ DVA: RAP# AR03 (all codes) For more information please refer to pg 7.

Code Left	Code Right	Size	Width (cm)
B211L M	B211RM	S/M	7.5
B211L L	B211RL	L	9



Cosmac Cock - Up Resting Hand Splint With Thumb

- Pre-shaped plastic (with thumb) with velcro fastening straps
- Use for carpal tunnel syndrome, RSI, resting splint

✓ DVA: RAP# AR03 (all codes) For more information please refer to pg 7.

Code Left	Code Right	Size	Width (cm)
B212LM	B212RM	S/M	7.5
B212LL	B212RL	L	9



Oppo 1024 Universal Knee Support

- Designed for all knee sizes with adjustable support
- Open patella relieves pressure
- Provides compression for weak or overstressed knees
- Exclusive reinforced patella stabiliser to prevent displacement
- Retains body heat to warm knee joint and increases blood circulation

DVA: RAP# AR02 For more information please refer to pg 7.

Code	Description	Size
OPP1024	Oppo 1024 universal knee support	Universal size



Oppo 1124 Knee Support Short

- Wrap - around design allows for adjustable fit and unrestricted range of motion of the knee
- Open patella design to relieve pressure
- Exclusive reinforced patella stabilizer to prevent displacement
- Heat retention and compression reduces potential for strain or injury

DVA: RAP# AR02 For more information please refer to pg 7.

Code	Description	Size
OPP1124	Oppo 1124 knee support short	Universal size



Oppo 1125 Knee Support Short Donut

- Adjustable wrap - around design for custom fit
- Open patella design relieves pressure on the kneecap
- Donut shape around the patella for added

DVA: RAP# AR02 For more information please refer to pg 7.

Code	Description	Size
OPP1125	Oppo 1125 knee support short donut	Universal size



Oppo 1224 Knee Support Long

- Wrap - around design allows for adjustable fit and unrestricted range of motion
- Open patella design to relieve pressure
- Exclusive reinforced patella stabiliser to prevent displacement
- Heat retention and compression reduces potential for strain or injury

DVA: RAP# AR02 For more information please refer to pg 7.

Code	Description	Size
OPP1224	Oppo 1224 knee support long	One size 31.8 - 40.6 cm

Note: Measure around the knee joint.



Oppo 1132 Contour Knee Support

- Unique contour shape to snugly fit the knee joint to prevent slipping due to excessive movement
- The adjustable design provides easy application and maximum support
- Breathable CoolPrene® material lined with COOLMAX® behind the knee for optimal comfort

DVA: RAP# AR02 For more information please refer to pg 7.

Code	Description	Size	(cm)
OPP1132S	Oppo 1132 contour knee support Small	S	33 - 39.4
OPP1132M	Oppo 1132 contour knee support Medium	M	39.4 - 43.2
OPP1132L	Oppo 1132 contour knee support Large	L	43.2 - 47
OPP1132XL	Oppo 1132 contour knee support Extra Large	XL	47 - 50.8



McDavid A408 Thermal Knee Wrap

- Multi purpose knee wrap
- Provides warmth, compression, & protection
- Contoured & darted for a better fit
- Retains body warmth & can increase blood circulation
- Fully adjustable

✓ DVA: RAP# AR02 For more information please refer to pg 7.

Code	Description	Size
NHA408	McDavid A408 thermal knee wrap Black	Universal size
NHN408	McDavid A408 thermal knee wrap Beige	Universal size



McDavid A409 Thermal Knee Wrap Open Patella

- Multi purpose knee wrap
- Provides warmth, compression, & protection
- Contoured & darted for a better fit
- Retains body warmth & can increase blood circulation
- Fully adjustable

✓ DVA: RAP# AR02 For more information please refer to pg 7.

Code	Description	Size
NHA409	McDavid A409 thermal knee wrap Open Patella - Black	Universal size
NHN409	McDavid A409 thermal knee wrap Open Patella - Beige	Universal size



Oppo 2029 Open Knee Brace

- Open design for better fit
- For arthritic knee conditions, minor sprains and strains
- Provides firm support and gentle compression over the kneecap
- Improves healing and keeps joints and muscles flexible

✓ DVA: RAP# AR02 For more information please refer to pg 7.

Code	Description	Size	(cm)
OPP2029S	Oppo 2029 open knee brace Small	S	30.5 - 34.3
OPP2029M	Oppo 2029 open knee brace Medium	M	34.3 - 38.1
OPP2029L	Oppo 2029 open knee brace Large	L	38.1 - 41.9
OPP2029XL	Oppo 2029 open knee brace Extra Large	XL	41.9 - 45.7
OPP2029XXL	Oppo 2029 open knee brace Extra Extra Large	XXL	45.7 - 49.5

Note: Measure around the mid - section of the knee, while in a standing position.



Oppo 2120 Knee Wrap

- Provides comfortable and uniform compression
- Made of unique extra - strength elastic and transverse nylon fibers for long - lasting, heavy - duty support
- Wrap may be pre - positioned for controlled compression

✓ DVA: RAP# AR02 For more information please refer to pg 7.

Code	Description	Size
OPP2120	Oppo 2120 knee wrap	Universal size



Oppo 1021 Knee Support Open Patella

- Provides compression for weak or overstressed knee
- Open patella design relieves pressure
- Exclusive reinforced patella stabiliser to prevent displacement
- Helpful for post - operative knee problems, strains and arthritis

✓ DVA: RAP# AR02 For more information please refer to pg 7.

Code	Description	Size	(cm)
OPP1021S	Oppo 1021 knee support open patella Small	S	33.7 - 35.9
OPP1021M	Oppo 1021 knee support open patella Medium	M	35.9 - 38.4
OPP1021L	Oppo 1021 knee support open patella Large	L	38.4 - 43.5
OPP1021XL	Oppo 1021 knee support open patella Extra Large	XL	43.5 - 51.1

Note: Measure around the mid - section of the knee, while in a standing position.



McDavid A401 Thermal Knee Support

- Basic multi purpose slip - on knee support
- Provides a low level of compression & support
- Helps ease painful, injured knees
- Lightweight ventilated elastic for all day comfort
- Warmth, firm compression & some protection
- Retains body warmth & can increase blood circulation

DVA: RAP# AR02 For more information please refer to pg 7.

Code - Black	Code - Beige	Size	(cm)
NHA401 B1	NHA401 S1	S	30 - 33
NHA401 B2	NHA401 S2	M	33 - 38
NHA401 B3	NHA401 S3	L	38 - 43
NHA401 B4	NHA401 S4	XL	43 - 51
NHA401 B5	NHA401 S5	XXL	51 - 56

Note: Measure around the knee joint.

- Reversible & lined both sides (Heavy duty outer lining for durability)



McDavid A402 Thermal Knee Support Open

- Warmth, firm compression & some protection
- Contoured & sized for a better fit
- Retains body warmth & can increase blood circulation
- Reversible & lined both sides (Heavy duty outer lining for durability)

DVA: RAP# AR02 For more information please refer to pg 7.

Code - Black	Code - Beige	Size	(cm)
NHA402B1	NHA402S1	S	30 - 33
NHA402B2	NHA402S2	M	33 - 38
NHA402B3	NHA402S3	L	38 - 43
NHA402B4	NHA402S4	XL	43 - 51
NHA402B5	NHA402S5	XXL	51 - 56

Note: Measure around the knee joint.



Rehband 8361 Genu Therma

- Provides warmth and compression, which helps to reduce pain and improves blood circulation
- Supports sensory motor control
- Elastic and supple made from a warming material
- Anatomic design with soft trimmings to provide excellent comfort and fit
- Can be used for left or right

DVA: RAP# AR02 For more information please refer to pg 7.

Code	Size	15 cm below mid-patella	15 cm above mid-patella
REH8361XXS	XXS	29 - 32	36 - 40
REH8361XS	XS	32 - 35	40 - 44
REH8361S	S	35 - 38	44 - 48
REH8361M	M	38 - 41	48 - 52
REH8361L	L	41 - 44	52 - 56
REH8361XL	XL	44 - 48	56 - 61
REH8361XXL	XXL	48 - 51	61 - 67

Note: Measure around leg, 15cm above, and 15cm below middle of knee.



Rehband 8364 Genu Therma Open

- Provides warmth and compression, which helps to reduce pain and improves blood circulation
- Supports sensory motor control
- Reduces pressure on the patella
- Anatomic design with soft trimmings to provide excellent comfort and fit
- Can be used for left or right

DVA: RAP# AR02 For more information please refer to pg 7.

Code	Size	15 cm below mid-patella	15 cm above mid-patella
REH8364XXS	XXS	29 - 32	36 - 40
REH8364XS	XS	32 - 35	40 - 44
REH8364S	S	35 - 38	44 - 48
REH8364M	M	38 - 41	48 - 52
REH8364L	L	41 - 44	52 - 56
REH8364XL	XL	44 - 48	56 - 61
REH8364XXL	XXL	48 - 51	61 - 67

Note: Measure around leg, 15cm above, and 15cm below middle of knee.



Rehband 8354 Genu Therma Fit

- Provides warmth and compression, which helps reduce pain and improve blood circulation
- Supports sensory motor control
- Reduces pressure on the patella
- Straps to ensure optimal fit and comfort
- Anatomic design with soft trimmings to provide excellent comfort and fit
- Two elastic straps
- Can be used for left or right

DVA: RAP# AR02 For more information please refer to pg 7.

Code	Size	15 cm below mid-patella	15 cm above mid-patella
REH8354XXS	XXS	29 - 32	36 - 40
REH8354XS	XS	32 - 35	40 - 44
REH8354S	S	35 - 38	44 - 48
REH8354M	M	38 - 41	48 - 52
REH8354L	L	41 - 44	52 - 56
REH8354XL	XL	44 - 48	56 - 61
REH8354XXL	XXL	48 - 51	61 - 67

Note: Measure around leg, 15cm above, and 15cm below middle of knee.



Oppo 2021 Open Patella Knee Support

- For arthritic knee conditions, minor sprains and strains provides firm support for the maintenance of joint structures with gentle compression over the kneecap
- Improves healing and keeps joints and muscles flexible

✓ DVA: RAP# AR02 For more information please refer to pg 7.

Code	Description	Size	(cm)
OPP2021S	Oppo 2021 open patella knee support Small	S	30.5 - 34.3
OPP2021M	Oppo 2021 open patella knee support Medium	M	34.3 - 38.1
OPP2021L	Oppo 2021 open patella knee support Large	L	38.1 - 41.9
OPP2021XL	Oppo 2021 open patella knee support Extra Large	XL	41.9 - 45.7

Note: Measure around the mid-section of the knee, while in a standing position.



Body Assist 450 Knee Support

- Basic multi purpose slip-on knee support
- Provides a low level of compression & support
- Helps ease painful, injured knees
- Lightweight ventilated elastic for all day comfort
- Retains some body warmth & can increase blood circulation

✓ DVA: RAP# AR02 For more information please refer to pg 7.

Code	Description	Size	(cm)
NH4501	Body Assist 450 knee support Small	S	Up to 32
NH4502	Body Assist 450 knee support Medium	M	32 - 37
NH4503	Body Assist 450 knee support Large	L	37 - 42
NH4504	Body Assist 450 knee support Extra Large	XL	42 - 47

Note: Measure around the knee joint.

- Length 18cm, colour white
- Also available in 30cm extra length (product code NH45L, beige)



Body Assist 45L (Long) Knee Support 30cm

- Basic multi purpose slip-on knee support
- Provides a low level of compression & support
- Helps ease painful, injured knees
- Lightweight ventilated elastic for all day comfort
- Retains some body warmth & can increase blood circulation
- Length 30cm, colour beige

✓ DVA: RAP# AR02 For more information please refer to pg 7.

Code	Description	Size	(cm)
NH45L1	Body Assist 45L knee support 30cm Small	S	Up to 32
NH45L2	Body Assist 45L knee support 30cm Medium	M	32 - 37
NH45L3	Body Assist 45L knee support 30cm Large	L	37 - 42
NH45L4	Body Assist 45L knee support 30cm Extra Large	XL	42 - 47

Note: Measure around the knee joint.

- Also available in shorter 18cm length (product code NH450, white)



Oppo 1029 Patella Tendon Strap

- Extra pad provides compression on target area
- Non - slip backing keeps wrap from sliding out of position
- Great for use after an injury or to help prevent injuries
- Reduces vibrations in the femoral groove

✓ DVA: RAP# AR02 For more information please refer to pg 7.

Code	Description	Size	(cm)
OPP1029	Oppo 1029 patella tendon strap	One size	31.8 - 40.6

Note: Measure around the knee joint.



Oppo 1129 Patella Tendon Strap w/pad

- Innovative compression system offers optimal compression to the affected area, leaving the calf muscle free of constriction to enhance better comfort
- Reinforced cover provides strong protection during strenuous or daily activities. The prominence inside offers effective pressure and helps consistently maintain the compression force on the patella tendon

✓ DVA: RAP# AR02 For more information please refer to pg 7.

Code	Description	Size	(cm)
OPP1129S/M	Oppo 1129 patella tendon strap w/ pad Small/Medium	S/M	26.7 - 34.9
OPP1129L/XL	Oppo 1021 knee support open patella Large/Extra Large	L/XL	34.9 - 43.2

Note: Measure around the mid-section of the knee, while in a standing position.

- The unique design of pad insert combined with straps allows for adjustment of the compression, precisely in the front of the knee



Oppo 1429 Jumpers Strap w/pad

- Specially shaped silicone insert offers extra pressure on the patella
- Adjustable hook and loop strap allows you to apply greater tension if needed
- Minimizes potential for future injuries

✓ DVA: RAP# AR02 For more information please refer to pg 7.

Code	Description	Size	(cm)
OPP1429	Oppo 1429 jumpers strap w/pad	One size	31.8 - 40.6

Note: Measure around the knee joint.



McDavid A414 Patella Knee Strap

- A semi-tubular buttress in a thermal strap with velcro closure
- For compression and pressure on the patellar tendon

✓ DVA: RAP# AR02 For more information please refer to pg 7.

Code	Description	Size
NHA414B	McDavid A414 patella knee strap Black	Universal size
NHA414S	McDavid A414 patella knee strap Beige	Universal size



Oppo 1025 Knee Support with Patella Strap

- Does not restrict normal motion while knee support is worn during exercise
- Adjustable patella tendon strap provides extra compression on targeted area
- May be easily applied to swollen or injured knees without pulling or tugging
- Fits either left or right knee

✓ DVA: RAP# AR02 For more information please refer to pg 7.

Code	Size	(cm)
OPP1025S	S	33.0 - 36.8
OPP1025M	M	36.8 - 40.6
OPP1025L	L	40.6 - 44.5
OPP1025XL	XL	44.5 - 48.3

Note: Measure around the mid-section of the knee, while in a standing position.



Oppo 1028 Patella Tracker Support

- Prevents patella pain and weakness due to instability
- Helps maintain proper patella position
- Helps prevent Chondromalacia Patella
- The pad design ensures comfortable fit and provides even pressure to the side of the knee
- Does not interfere with normal motion, even when straps are crossed

✓ DVA: RAP# AR02 For more information please refer to pg 7.

Code	Size	(cm)
OPP1028XS	XS	30.5 - 33.0
OPP1028S	S	33.0 - 35.6
OPP1028M	M	35.6 - 38.1
OPP1028L	L	38.1 - 40.6
OPP1028XL	XL	40.6 - 43.2
OPP1028XXL	XXL	43.2 - 45.5

Note: Measure around the mid-section of the knee, while in a standing position.



Body Assist PSB Patella Stabilising Brace

- Designed according to knee cap taping technique, locking the knee cap
- Anatomically shaped to provide orthopaedic support
- Retains some body warmth & can increase blood circulation
- A great brace for anyone who needs to tape their knee cap

✓ DVA: RAP# AR02 For more information please refer to pg 7.

Code	Size	(cm)
NHPSBCHILD	Child	Up to 32
NHPSB	Regular	32 - 42
NHPSBXLG	XLarge	42+

Note: Measure around the knee joint.



Rehband 8360N Genu Carezza Patella Stabiliser

- Keeps patella in correct position
- Prevents patella from luxation
- Supports sensory motor control
- Flexible patella stabiliser
- C-shaped pad, which is adjusted by two separate straps
- Innovative material that combines compression and breathability
- Excellent fit underneath clothes

✓ DVA: RAP# AR02 For more information please refer to pg 7.

Code	Size	15 cm below mid-patella	15 cm above mid-patella
REH8360NXXS	XXS	29 - 32	36 - 40
REH8360NXS	XS	32 - 35	40 - 44
REH8360NS	S	35 - 38	44 - 48
REH8360NM	M	38 - 41	48 - 52
REH8360NL	L	41 - 44	52 - 56
REH8360NXL	XL	44 - 48	56 - 61
REH8360NXXL	XXL	48 - 51	61 - 67

Note: Measure around leg, 15cm above, and 15cm below middle of knee.



Oppo 1033 Knee Support Patella Stabiliser

- Neoprene circle pad around the patella provides protection and stabilisation to prevent patella displacement
- Four neoprene straps provide support directly to patella area
- Two medial and lateral spiral stays provide additional support and stability for the knee
- Helps relieve pain from tendinitis and arthritis

✓ DVA: RAP# AR02 For more information please refer to pg 7.

Code	Size	(cm)
OPP1033S	XXS	33.7 - 37.5
OPP1033M	XS	37.5 - 40.6
OPP1033L	S	40.6 - 45.1
OPP1033XL	M	45.1 - 50.2

Note: Measure around the mid-section of the knee, while in a standing position.

- Retains body heat to warm knee joint and increases blood circulation



Rehband 8387 Genu Therma Combi

- Relieves the pressure on the patellar tendon insertion
- Adjustable patella tendon strap
- The adjustable anchor above the knee prevents the brace from migrating or rotating
- Excellent for sports and exercises when you have pain behind or below the kneecap
- Can be used for left or right

✓ DVA: RAP# AR02 For more information please refer to pg 7.

Code	Size	15 cm below mid-patella	15 cm above mid-patella
REH8387XXS	XXS	29 - 32	36 - 40
REH8387XS	XS	32 - 35	40 - 44
REH8387S	S	35 - 38	44 - 48
REH8387M	M	38 - 41	48 - 52
REH8387L	L	41 - 44	52 - 56
REH8387XL	XL	44 - 48	56 - 61
REH8387XXL	XXL	48 - 51	61 - 67

Note: Measure around leg, 15cm above, and 15cm below middle of knee.



Oppo 1038 Knee Support

- Two stays on both sides provide additional stability
- Adjustable hook and loop closure for custom fit
- Provides warmth and equal compression to weak or overstress knee

✓ DVA: RAP# AR02 For more information please refer to pg 7.

Code	Description	Size	(cm)
OPP1038S/M	Oppo 1038 knee support Small/Medium	S/M	33.0 - 38.1
OPP1038L/XL	Oppo 1038 knee support Large/Extra Large	L/XL	38.1 - 50.8

Note: Measure around the mid - section of the knee, while in a standing position.



Oppo 1230 Adjustable Knee Stabiliser

- Two medial and lateral spiral stays provide additional support and stability for the knee
- The additional circle pad around the patella provides padded protection and stabilization to prevent patella displacement
- Open patella design to relieve pressure

✓ DVA: RAP# AR02 For more information please refer to pg 7.

Code	Description	Size	(cm)
OPP1230	Oppo 1230 adjustable knee stabilizer	One size	31.8 - 40.6

Note: Measure around the knee joint.

- Heat retention and compression reduces potential for strain or injury



Oppo 1130 Knee Stabiliser Adjustable

- Two medial and lateral spiral stays provide additional support and stability for the knee
- Heat retention and compression reduces potential for strain or injury
- Adjustable for custom fit

DVA: RAP# AR02 For more information please refer to pg 7.

Code	Description	Size	(cm)
OPP1130	Oppo 1130 knee stabiliser	One size	31.8- 40.6

Note: Measure around the knee joint.



Rehband 8362N Genu Carezza Knee Support

- Support and stabilization by coil springs
- Supports sensory motor control
- Wraparound design for easy application
- Lateral and medial coil springs for stability and to prevent the brace from rolling
- Anatomic design with soft trimmings to provide excellent comfort and fit
- Innovative material that combines compression and breathability

DVA: RAP# AR02 For more information please refer to pg 7.

Code	Size	15 cm below mid-patella	15 cm above mid-patella
REH8362N XXS	XXS	29 - 32	36 - 40
REH8362N XS	XS	32 - 35	40 - 44
REH8362N S	S	35 - 38	44 - 48
REH8362N M	M	38 - 41	48 - 52
REH8362N L	L	41 - 44	52 - 56
REH8362NXL	XL	44 - 48	56 - 61

Note: Measure around leg, 15cm above, and 15cm below middle of knee.



Body Assist 43C Elastic Cartilage Knee Brace

- Adjustable front closure, lateral/medial condyle pads & patella cutout
- Firm elastic orthopaedic soft tissue support with additional compression over the medial and lateral meniscus (cartilage)
- Three medial and three lateral spring steel stays provide greater support

DVA: RAP# AR02 For more information please refer to pg 7.

Code	Size	(cm)
NH43C 1	S	Up to 32
NH43C 2	M	32 - 37
NH43C 3	L	37 - 42
NH43C 4	XL	42 - 47
NH43C 5	XXL	47+

Note: Measure around the knee joint.



Oppo 1030 Knee Stabiliser

- Neoprene circle pad around the patella provides padded protection and stabilisation to prevent patella displacement
- Two medial and lateral stays provide additional support and stability for the knee
- Helps relieve pain from tendinitis and arthritis
- Retains body heat to warm knee joint and increases blood circulation

DVA: RAP# AR02 For more information please refer to pg 7.

Code	Size	(cm)
OPP1030 S	S	33.7 - 37.5
OPP1030 M	M	37.5 - 40.6
OPP1030 L	L	40.6 - 45.1
OPP1030 XL	XL	45.1 - 50.2

Note: Measure around the mid-section of the knee, while in a standing position.

- Two hook and loop straps insure comfortable fit and stabilisation during activities



McDavid A415B Cartilage Knee Support

- Buttress protects and relieves pressure from the patella
- Two medial and 2 lateral spring steel stays provide greater support
- Firm compression and soft tissue support with additional compression over the medial and lateral ligaments
- Cushions against minor scrapes and bumps

DVA: RAP# AR02 For more information please refer to pg 7.

Code	Size	(cm)
NHA415B1	S	30 - 33
NHA415B2	M	33 - 38
NHA415B3	L	38 - 43
NHA415B4	XL	43 - 51
NHA415B5	XXL	51 - 56

Note: Measure around the knee joint.



McDavid A416 Thermal Collateral Knee Support

- Sewn - in buttress protects and relieves pressure from the patella
- Includes 2 medical spring stays on both sides of the knee for extra support

✓ DVA: RAP# AR02 For more information please refer to pg 7.

Code	Size	(cm)
NHA4161	S	30 - 33
NHA4162	M	33 - 38
NHA4163	L	38 - 43
NHA4164	XL	43 - 51
NHA4165	XXL	51 - 56

Note: Measure around the knee joint.



McDavid A421 Patella Knee Support

- Delivers firm compression & soft tissue support
- Made of medical grade lightweight neoprene that retains body warmth
- Contoured design for a better fit with two medial and two lateral medical steel stays
- Top and bottom anchor straps to minimise slippage

✓ DVA: RAP# AR02 For more information please refer to pg 7.

Code - Black	Code - Beige	Size	(cm)
NHA421B1	NHA421S1	S	30 - 33
NHA421B2	NHA421S2	M	33 - 38
NHA421B3	NHA421S3	L	38 - 43
NHA421B4	NHA421S4	XL	43 - 51
NHA421B5	NHA421S5	XXL	51 - 56

Note: Measure around the knee joint.

- Available in Beige or Black



McDavid A425 Ligament Knee Support

- Delivering firm compression and soft tissue support
- Made of medical grade lightweight neoprene that retains body warmth
- 4 elastic straps that deliver additional support to ligaments
- Horse-shoe buttress to stabilise the knee cap
- Contoured design for a better fit with two medial and two lateral medical steel stays

✓ DVA: RAP# AR02 For more information please refer to pg 7.

Code - Black	Code - Beige	Size	(cm)
NHA425B1	NHA425S1	S	30 - 33
NHA425B2	NHA425S2	M	33 - 38
NHA425B3	NHA425S3	L	38 - 43
NHA425B4	NHA425S4	XL	43 - 51
NHA425B5	NHA425S5	XXL	51 - 56

Note: Measure around the knee joint.

- Top and bottom anchor straps minimise slippage



Oppo 3033 Spiral Knee Brace

- Unique breathable mesh fabric covered with ceramic cotton lining keeps skin dry and comfortable
- Two medial and lateral spiral stays on both sides provide additional support and stability for the knee
- Provides firm support for the maintenance of the knee joint structures with gentle compression over the knee cap

✓ DVA: RAP# AR02 For more information please refer to pg 7.

Code	Size	(cm)
OPP3033S	S	28.6 - 33.7
OPP3033M	M	33.7 - 40.6
OPP3033L	L	40.6 - 47.6
OPP3033XL	XL	47.6 - 55.2

Note: Measure around the mid-section of the knee, while in a standing position.

- Helps relieve pain resulting from injured or weak knee conditions
- The open buttress can be positioned to stabilise the patella



Oppo 2130 Knee Support Spiral

- Four medial and lateral metal stays provide additional support and stability for the knee
- For arthritic knee conditions, minor sprains and strains
- Provides firm support and gentle compression over the kneecap
- Retains heat to relieve pain

✓ DVA: RAP# AR02 For more information please refer to pg 7.

Code	Size	(cm)
OPP2130S	S	30.5 - 34.3
OPP2130M	M	34.3 - 38.1
OPP2130L	L	38.1 - 41.9
OPP2130XL	XL	41.9 - 45.7

Note: Measure around the mid-section of the knee, while in a standing position.

- Improves healing and keeps joints and muscles flexible



Body Assist 42S Knee Support

- An open patella with medial & lateral medical side stays for extra overall support
- Open Patella minimises pressure over the knee cap
- Quality lightweight elastic orthopaedic soft tissue support with additional side supports

✓ DVA: RAP# AR02 For more information please refer to pg 7.

Code	Size	(cm)
NH42S1	S	30.5 - 35.5
NH42S2	M	33 - 38
NH42S3	L	35.5 - 40.5
NH42S4	XL	40.5 - 46
NH42S5	XXL	46 +

Note: Measure around the knee joint.



Body Assist 41S Cross - Cut Elastic Knee Brace

- Anatomically shaped by a cross-cut design that minimises irritation & pressure behind the knee
- Provides orthopaedic support for minor knee joint strains & sprains
- Removable medical support spring stays on sides of the knee joint to provide medio-lateral support
- Brace retains some body warmth & can increase blood circulation

✓ DVA: RAP# AR02 For more information please refer to pg 7.

Code	Size	(cm)
NH41S1	S	Up to 32
NH41S2	M	32 - 37
NH41S3	L	37 - 42
NH41S4	XL	42 - 47
NH41S5	XXL	47+

Note: Measure around the knee joint.

- Lightweight, ventilated elastic for all day comfort



Oppo 1032 Knee Support Post Operative

- Reduces swelling and pain following arthroscopic surgery and enhances protection of periarticular structures
- Provides comfortable and controlled compression with adjustable hook and loop closures
- Front opening design for easy fit and comfort

✓ DVA: RAP# AR02 For more information please refer to pg 7.

Code	Size	(cm)
OPP1032S	S	33.7 - 37.5
OPP1032M	M	37.5 - 40.6
OPP1032L	L	40.6 - 45.1
OPP1032XL	XL	45.1 - 50.2

Note: Measure around the mid-section of the knee, while in a standing position.



Body Assist 43H Hinged Knee Brace

- Rigid hinges minimise excessive medio - lateral movement of the knee joint, while offering excellent support & stability
- Made from lightweight medical grade orthopaedic elastic & features front closures for easier application
- Top & bottom straps lock the brace in position & minimise movement

✓ DVA: RAP# AR02 For more information please refer to pg 7.

Code	Size	(cm)
NH43H1	S	Up to 32
NH43H2	M	32 - 37
NH43H3	L	37 - 42
NH43H4	XL	42 - 47
NH43H5	XXL	47+

Note: Measure around the knee joint.



Rehband 8353N Genu Direxa Knee Support

- Sensorimotor performance improvements through controlled compression
- Pain relief and functional improvement of the knee joint
- Polycentric joints with extension and flexion stops of the full range of motion
- Innovative material that combines compression and breathability
- For patients with restricted grip force and mobility

✓ DVA: RAP# AR02 For more information please refer to pg 7.

Code	Size	15 cm below mid-patella	15 cm above mid-patella
REH8353NXXS	XXS	29 - 32	36 - 40
REH8353NXS	XS	32 - 35	40 - 44
REH8353NS	S	35 - 38	44 - 48
REH8353NM	M	38 - 41	48 - 52
REH8353NL	L	41 - 44	52 - 56
REH8353NXL	XL	44 - 48	56 - 61
REH8353NXXL	XXL	48 - 51	61 - 67

Note: Measure around leg, 15cm above, and 15cm below middle of knee.



Oppo 1031 Knee Stabiliser Hinged

- Neoprene circle pad around the patella provides padded protection and stabilisation to prevent patella displacement
- Two medial and lateral stays provide additional support and stability for the knee
- Two hook and loop straps insure comfortable fit and stabilisation during activities

DVA: RAP# AR02 For more information please refer to pg 7.

Code	Size	(cm)
OPP1031S	S	33.7 - 37.5
OPP1031M	M	37.5 - 40.6
OPP1031L	L	40.6 - 45.1
OPP1031XL	XL	45.1 - 50.2

Note: Measure around the mid-section of the knee, while in a standing position.

- Helps relieve pain from tendinitis and arthritis
- Retains body heat to warm knee joint and increases blood circulation



McDavid A426 Thermal Hinged Knee Brace

- Long sleeve with a superior horse shoe buttress, medial & lateral hinges & velcro straps for adjustment
- Offers ligament & patellar support & stability
- Metal hinges deliver extra firm medio-lateral support

DVA: RAP# AR02 For more information please refer to pg 7.

Code - Black	Code - Beige	Size	(cm)
NHA426B1	NHA426S1	S	30 - 33
NHA426B2	NHA426S2	M	33 - 38
NHA426B3	NHA426S3	L	38 - 43
NHA426B4	NHA426S4	XL	43 - 51
NHA426B5	NHA426S5	XXL	51 - 56

Note: Measure around the mid-section of the knee, while in a standing position.



McDavid A429 PSII Hinged Knee

- Hinged knee with molded condyle pads that offer superior fit, comfort & protection
- Professional quality bilateral design
- Geared rigid upright polycentric hinges provide additional medial-lateral support
- Features superior horseshoe buttress & hyper-extension stops

DVA: RAP# AR02 For more information please refer to pg 7.

Code	Size	(cm)
NHA429 1	S	30 - 33
NHA429 2	M	33 - 38
NHA429 3	L	38 - 43
NHA429 4	XL	43 - 51
NHA429 5	XXL	51 - 56

Note: Measure around the knee joint.

- Top & bottom velcro strap locks eliminate brace movement



Oppo 2031 Knee Open Patella Support

- May be used for stabilisation and support of the knee following strains, injury or surgery
- Elastic brace with motion hinges provides medial and lateral support for the unstable knee
- Provides firm support for the maintenance of joint structures with gentle compression over the kneecap
- For arthritic knee conditions, minor sprains and strains

DVA: RAP# AR02 For more information please refer to pg 7.

Code	Size	(cm)
OPP2031S	S	30.5 - 34.3
OPP2031M	M	34.3 - 38.1
OPP2031L	L	38.1 - 41.9
OPP2031XL	XL	41.9 - 45.7

Note: Measure around the mid-section of the knee, while in a standing position.

- Two hook and loop straps insure comfortable fit



Oppo 2137 Knee Brace Hinged

- Convenient flexion/extension pin-stops give a custom controlled range of motion
- Removable hook and loop casings permit exact positioning at the knee joint center
- Adjustable straps provide custom fit and controlled compression
- Provides maximum medial and lateral support and prevents hyper-extension of the knee

DVA: RAP# AR02 For more information please refer to pg 7.

Code	Size	(cm)
OPP2137S	S	30.5 - 34.3
OPP2137M	M	34.3 - 38.1
OPP2137L	L	38.1 - 41.9
OPP2137XL	XL	41.9 - 45.7

Note: Measure around the mid-section of the knee, while in a standing position.

- Elastic pockets with medial and lateral flexible stays for extra support and stabilisation



Rehband 8367N Direxa Stable Knee Support

- Sensorimotor performance improvements through controlled compression
- Pain relief and functional improvement of the knee joint
- Polycentric joints with gradual extension and flexion stops (extension 0°; 10°; 20°; 30°; 45°) (flexion 0°; 10°; 20°; 30°; 45°; 60°; 75°; 90°)
- Two non-elastic, circular strap systems

DVA: RAP# AR02 For more information please refer to pg 7.

Code	Size	15 cm below mid-patella	15 cm above mid-patella
REH8367NXXS	XXS	29 - 32	36 - 40
REH8367NXS	XS	32 - 35	40 - 44
REH8367NS	S	35 - 38	44 - 48
REH8367NM	M	38 - 41	48 - 52
REH8367NL	L	41 - 44	52 - 56
REH8367NXL	XL	48 - 48	56 - 61
REH8367NXXL	XXL	48 - 51	61 - 67

Note: Measure around leg, 15cm above, and 15cm below middle of knee.



Rehband 8368N Genu Direxa Stable ROM Long

- Sensorimotor performance improvements through controlled compression
- Pain relief and functional improvement of the knee joint
- Four-strap stabilisation
- Polycentric joints with gradual extension and flexion stops (extension 0°; 10°; 20°; 30°; 45°) (flexion 0°; 10°; 20°; 30°; 45°; 60°; 75°; 90°)

DVA: RAP# AR02 For more information please refer to pg 7.

Code - Left	Code - Right	Size	15 cm below mid-patella	15 cm above mid-patella
REH8368N XXS-L	REH8368N XXS-R	XXS	29 - 32	36 - 40
REH8368N XS-L	REH8368N XS-R	XS	32 - 35	40 - 44
REH8368N S-L	REH8368N S-R	S	35 - 38	44 - 48
REH8368N M-L	REH8368N M-R	M	38 - 41	48 - 52
REH8368N L-L	REH8368N L-R	L	41 - 44	52 - 56
REH8368N XL-L	REH8368N XL-R	XL	48 - 48	56 - 61
REH8368N XXL-L	REH8368N XXL-R	XXL	48 - 51	61 - 67



Oppo 1036 Knee Support Multi Orthosis

- Functional 3/16" breathable neoprene knee brace
- Polycentric hinge with flexion and extension pin-stops for controlled range of motion
- Increases stability and provides support and protection
- Provides greatest comfort even in the hollow of the knee

DVA: RAP# AR02 For more information please refer to pg 7.

Code	Size	(cm)
OPP1036S	S	33.7 - 37.5
OPP1036M	M	37.5 - 40.6
OPP1036L	L	40.6 - 45.1
OPP1036XL	XL	45.1 - 50.2

Note: Measure around the mid-section of the knee, while in a standing position.

- For patients with restricted grip force and mobility
- Lightweight, open patella design



McDavid A427 Deluxe Thermal Hinged Knee Brace

- Offers the highest level of support for the knee joint
- Long sleeve design
- Made of medical grade thermal neoprene
- Medial & lateral hinges with 4 way adjustment control for hyperextension stops at 0, 15, 30 & 45 degrees
- Top & bottom velcro strap locks eliminate brace movement

DVA: RAP# AR02 For more information please refer to pg 7.

Code - Black	Code - Beige	Size	(cm)
NHA427B 1	NHA427S 1	S	30 - 33
NHA427B 2	NHA427S 2	M	33 - 38
NHA427B 3	NHA427S 3	L	38 - 43
NHA427B 4	NHA427S 4	XL	43 - 51
NHA427B 5	NHA427S 5	XXL	51 - 56

Note: Measure around the knee joint.

- Features a superior horseshoe buttress



Excel 4239 ROM Knee Brace

- Functional knee brace with range of motion hinges and flexion/extension settings between 0 - 90 degrees
- Designed for the functional management of ACL/PCL instability
- Semi-rigid of frame and strong straps prevent rotation and brace migration
- Brace may be molded for custom fit

DVA: RAP# AR02 For more information please refer to pg 7.

Code - Left (L)	Code - Right (R)	Size	(cm)
OPP4239S-L	OPP4239S-R	S	43 - 48
OPP4239M-L	OPP4239M-R	M	48 - 53
OPP4239L-L	OPP4239L-R	L	53 - 58
OPP4239XL-L	OPP4239XL-R	XL	58 - 65.5

Note: Measure thigh circumference 15cm above the mid-patella.



Oppo 4039 Post-Op Motion Control Knee Splint

- Provides stability to an injured or unstable knee by allowing normal knee joint motion with proper settings or stops within a selected range
- For use following knee surgery, early cast removal or post-operative rehabilitation
- Settings from 0 to 120 degrees flexion and between 0 to 75 degrees extension in 7.5 degree increments

✓ DVA: RAP# AR02 For more information please refer to pg 7.

Code	Knee Circ. (cm)	Length (cm)
OPP4039-18	43.2 - 71.1	46
OPP4039-22	43.2 - 71.1	56
OPP4039-26	43.2 - 71.1	66

Note: Measure around the knee joint.

- Hook and loop closures for uniform compression and support
- Available in three length: 45.7cm, 55.8cm and 60cm



Oppo Post-Op Motion Control Cool Knee Splint

- Designed for greater breathability and patient comfort
- Features a lightweight design
- Precision flexion and extension settings are achievable in a single continuous motion—simply press, rotate and release
- One size fits all

✓ DVA: RAP# AR02 For more information please refer to pg 7.

Code	Description	Size
AUPHYCP	Oppo post-op motion control cool knee splint	Universal size



BodyAssist A441 Post-Op Knee Brace

- heavy duty 'Polycentric' hinges provide a range of limited motion & help to prevent hyper-extension of the knee via stops in the hinges
- Provides better medial/lateral stability to the knee while tracking more closely with knee motion
- Extension & flexion stops from 0°, to 90° at 10° stops
- Final backstop at 150°

✓ DVA: RAP# AR02 For more information please refer to pg 7.

Code	Description	Size
NHA441	BodyAssist A441 post op knee brace	Universal size

- Range of motion can be set easily without tools
- Made of medical beige neoprene in an easy wrap-around style with four adjustable securing straps
- One size & universal left or right leg fitting
- Quality construction for superior durability & anatomically contoured for a better fit



Oppo 4030 Knee Immobiliser

- Provides varying degrees of support and stabilization for the leg and knee
- Foam padding reduces slippage and will not fray
- Aluminum posterior stays retain proper position for comfort
- Hook and loop closure provides quick, secure fit
- Available in three heights, 45.7cm, 50.8cm and 58.4cm

✓ DVA: RAP# AR02 For more information please refer to pg 7.

Code - 46cm Length	Code - 51cm Length	Code - 58cm Length	Size	(cm)
OPP4030S-46	OPP4030S-51	OPP4030S-58	S	33 - 38.1
OPP4030M-46	OPP4030M-51	OPP4030M-58	M	38.1 - 45.7
OPP4030L-46	OPP4030L-51	OPP4030L-58	L	45.7 - 53.3
OPP4030XL-46	OPP4030XL-51	OPP4030XL-58	XL	53.3 - 61

Note: Measure the circumference of the thigh approximately 10cm above the knee.



Oppo Tri-Panel Knee Immobiliser

- Universal knee immobiliser
- 3 panel design
- 2 side panels velcro on to the middle panel to allow a range of circumferential sizing
- One size fits all (length: 51cm)

✓ DVA: RAP# AR02 For more information please refer to pg 7.

Code	Description	Size
AUPHYKI	Oppo tri-panel knee immobiliser	Universal size



Post - Op Knee Immobiliser

- Removable medial, lateral and posterior aluminium stays can be contoured to the shape of the leg for a comfortable and secure fit
- The 3 panel design (including the popliteal variation) allows adjustment of the brace
- Will fit calf to 46.5cm, and thigh to 56.5cm

✓ DVA: RAP# AR02 For more information please refer to pg 7.

Code	Size	(cm)	Length
SM800	Universal size	40	Short
SM813	Universal size	48	Medium
SM814	Universal size	58	Long



BodyAssist 480W Thigh Tendon Strap

- Rigid tendon strap that delivers firm support and assists in minimizing further injury to the thigh
- Designed by a physiotherapist to assist in chronic thigh injury as a rehabilitative device
- Suitable for use in various sports

✓ DVA: RAP# AR02 For more information please refer to pg 7.

Code	Description	Size
NH480W	BodyAssist 480W thigh tendon strap	Universal size



McDavid A478 Thermal Thigh Wrap

- Provides warmth, firm compression for strains & hamstring pulls
- For minor protection & shock absorption & helps reduce muscle strain
- Simple application with Velcro closure
- One size fits most
- Retains body warmth & can increase blood circulation
- Ideal for corked thigh condition

✓ DVA: RAP# AR02 For more information please refer to pg 7.

Code	Description	Size
NHA478	McDavid A478 thermal thigh wrap	Universal size



BodyAssist N478 Thermal Thigh Wrap

- Provides warmth, firm compression for strains & hamstring pulls
- For minor protection & shock absorption & helps reduce muscle strain
- Simple application with Velcro closure
- One size fits most
- Ideal for corked thigh condition

✓ DVA: RAP# AR02 For more information please refer to pg 7.

Code	Description	Size
NHN478	BodyAssist N478 thermal thigh wrap	Universal size

- Retains body warmth & can increase blood circulation



Oppo 1040 Slip-On Thigh Support

- Provides comfortable compression for weak or overstressed thigh and hamstring muscles
- Helps reduce pain from tendonitis
- Retains body heat to warm the thigh and increase blood circulation
- Minimizes the potential for future injuries

✓ DVA: RAP# AR02 For more information please refer to pg 7.

Code	Description	Size	(cm)
OPP1040S	Oppo1040 slip-on thigh support Small	S	45.1 - 50.8
OPP1040M	Oppo1040 slip-on thigh support Medium	M	50.8 - 57.2
OPP1040L	Oppo1040 slip-on thigh support Large	L	57.2 - 62.2
OPP1040XL	Oppo1040 slip-on thigh support Extra Large	XL	62.2 - 68.9

Note: Measure around mid-section of the thigh.



Oppo 2240 Slip-On Thigh Brace

- Provides firm support and compression to weak, injured thighs
- Effective support for strained groin muscles and torn hamstrings

DVA: RAP# AR02 For more information please refer to pg 7.

Code	Description	Size	(cm)
OPP2240S	Oppo 2240 slip-on thigh brace Small	S	36.2 - 44.5
OPP2240M	Oppo 2240 slip-on thigh brace Medium	M	44.5 - 53.3
OPP2240L	Oppo 2240 slip-on thigh brace Large	L	53.3 - 63.5

Note: Measure around mid-section of the thigh.



BodyAssist 490 Elastic Slip-On Thigh Support

- General multi purpose slip-on elastic thigh support
- Lightweight ventilated cotton elastic for improved comfort
- Ideal for holding a hot or cold pack
- Retains some body warmth & can increase blood circulation

DVA: RAP# AR02 For more information please refer to pg 7.

Code	Description	Size	(cm)
NH4901	BodyAssist 490 elastic slip-on thigh support Small	S	Up to 44
NH4902	BodyAssist 490 elastic slip-on thigh support Medium	M	44 - 50
NH4903	BodyAssist 490 elastic slip-on thigh support Large	L	50 - 56
NH4904	Oppo1040 Slip-on thigh support Extra Large	XL	56+

Note: Measure around mid-section of the thigh.



Oppo 2420 Silicone Wrap

- Provides localised support and compression, and avoids unnecessary compression to areas where it is not required
- Tension is fully adjustable to provide from light support to total compression
- Cohesive fabric, causing no pain or irritation to the skin whilst in use, comfortable to wear and painless to remove
- 7.5cm width
- Can be used for thigh, hamstring, knee or calf

DVA: RAP# AR02 For more information please refer to pg 7.

Code	Description	Size
OPP2420	Oppo 2420 silicone wrap	Universal size



Oppo 1010 Slip-On Shin Support

- Designed to fit the upper portion of the tibia and calf
- Provides compression and support over the calf and shin
- Retains body heat to warm shin and increase blood circulation
- Minimises the potential for future injuries

DVA: RAP# AR02 For more information please refer to pg 7.

Code	Description	Size	(cm)
OPP1010S	Oppo 1010 Slip-on shin support Small	S	33.0 - 36.2
OPP1010M	Oppo 1010 Slip-on shin support Medium	M	36.2 - 39.4
OPP1010L	Oppo1010 Slip-on thigh support Large	L	39.4 - 42.5
OPP1010XL	Oppo1010 Slip-on thigh support Extra Large	XL	42.5 - 46.4

Note: Measure around mid-section of the shin.



Oppo 2210 Slip-On Shin Brace

- For minor sprains and strains of shin muscles
- Provides firm support and compression to weak, injured shins
- Helps minimise further injury

DVA: RAP# AR02 For more information please refer to pg 7.

Code	Description	Size	(cm)
OPP2210S	Oppo 2210 slip-on shin brace Small	S	30.8 - 35.6
OPP2210M	Oppo 2210 slip-on shin brace Medium	M	35.6-40.6
OPP2210L	Oppo 2210 slip-on shin brace Large	L	40.6 - 45.7
OPP2210XL	Oppo 2210 slip-on shin brace Extra Large	XL	45.7 - 50.8

Note: Measure around mid-section of the shin.



BodyAssist 420 Elastic Slip-On Calf Support

- Strong compression & orthopaedic support for strains & shin splints
- Lightweight ventilated elastic for comfort
- Provides low level support & delivers some protection
- Retains some body warmth & can increase blood circulation

DVA: RAP# AR02 For more information please refer to pg 7.

Code	Description	Size	(cm)
NH4201	BodyAssist 420 elastic slip-on calf support Small	S	Up to 35.5
NH4202	BodyAssist 420 elastic slip-on calf support Medium	M	35.5 - 38
NH4203	BodyAssist 420 elastic slip-on calf support Large	L	38 - 43
NH4204	BodyAssist 420 elastic slip-on calf support Extra Large	XL	43+

Note: Measure around widest section of calf.



McDavid A430B Open Thermal Ankle Support

- Fully adjustable thermal ankle support with 2 orthopaedic elastic (figure 8) adjustable straps for graduated support
- Lined both sides
- Outer lining is made of heavy duty nylon for greater durability
- Provides all the benefits of thermal compression together with added outer support layer

DVA: RAP# AR02 For more information please refer to pg 7.

Code	Description	Size
NHA430B	McDavid A430B open thermal ankle support	Universal size

- Protects and supports without restriction and fits left or right
- One size fits most



McDavid A438 Thermal Ankle Wrap

- One size thermal ankle wrap providing the benefits of heat & compression
- Adjustable closures ensure an optimum fit & easy application & removal
- Compresses and supports soft tissue while retaining therapeutic heat
- Allows increased blood circulation
- Fits easily into standard footwear

DVA: RAP# AR01 For more information please refer to pg 7.

Code	Description	Size
NHA438B	McDavid A438 thermal ankle wrap Black	Universal size
NHA438S	McDavid A438 thermal ankle wrap Beige	Universal size

- Lined both sides
- One size fits most



Oppo 2101 Elastic Ankle Wrap

- Provides comfortable and uniform compression
- Made of unique extra-strength elastic and transverse nylon fibers for long-lasting, heavy-duty support
- Wrap may be pre-positioned for controlled compression

DVA: RAP# AR01 For more information please refer to pg 7.

Code	Description	Size
OPP2101	Oppo 2101 elastic ankle wrap	Universal size



Body Assist 01A10 Elastic Ankle Wrap with Heel Loop

- This one size elastic ankle wrap with loop anchor is simple to apply & very effective
- Simply hook the loop anchor over the heel & start wrapping
- The adjustable touch tape closure assures a perfect fit and locks down anywhere over itself
- Will not stick to skin

DVA: RAP# AR01 For more information please refer to pg 7.

Code	Description	Size
NH01A10B	Body Assist 01A10 elastic ankle wrap with heel loop Black	Universal size
NH01A10S	Body Assist 01A10 elastic ankle wrap with heel loop Beige	Universal size

- Pull hard & the strap locks rigid
- Orthopaedic elastic that locks like tape
- Fits easily into standard footwear



Oppo 2401 Silicon Ankle Wrap

- Provides localized support and compression, and avoids unnecessary compression to areas where it is not required
- Tension is fully adjustable to provide from light support to total compression
- Cohesive fabric, causing no pain or irritation to the skin whilst in use, comfortable to wear and painless to remove
- 7.5cm width

DVA: RAP# AR01 For more information please refer to pg 7.

Code	Description	Size
OPP2401	Oppo 2401 silicon ankle wrap	Universal size



Oppo 1001 Slip-On Thermal Ankle Support

- Open toe and heel design allows full range of movement
- Relieves pain due to strains and stiffness
- Provides compression for weak or overstressed ankles
- Helps ankle heal faster following injury

DVA: RAP# AR01 For more information please refer to pg 7.

Code	Description	Size	(cm)
OPP1001S	Oppo 1001 slip-on thermal ankle support Small	S	15.6 - 20.6
OPP1001M	Oppo 1001 slip-on thermal ankle support Medium	M	20.6 - 25.7
OPP1001L	Oppo 1001 slip-on thermal ankle support Large	L	25.7 - 30.8
OPP1001XL	Oppo 1001 slip-on thermal ankle support Extra Large	XL	30.8 - 35.9

Note: Measure circumference just above ankle bone.



Oppo 1003 Slip-On Thermal Ankle Support w/strap

- Removable surgical elastic strap allows adjustable compression and support for ankle joint
- Open toe and heel design allows full range of movement
- Relieves pain due to strains or stiffness
- Provides compression for weak or overstressed ankle

DVA: RAP# AR01 For more information please refer to pg 7.

Code	Size	(cm)
OPP1003S	S	15.6 - 20.6
OPP1003M	M	20.6 - 25.7
OPP1003L	L	25.7 - 30.8
OPP1003XL	XL	30.8 - 35.9

Note: Measure circumference just above ankle bone.



Oppo 1008 Slip-On Thermal Ankle Support

- Open heel design allows for comfortable fit and applies less pressure on the sensitive Achilles tendon area
- Detachable strap may be removed when additional compression is not needed
- Flexible spiral springs act like tendons to reinforce the ankle

DVA: RAP# AR01 For more information please refer to pg 7.

Code	Size	cm
OPP1008S	S	15.6 - 20.6
OPP1008M	M	20.6 - 25.7
OPP1008L	L	25.7 - 30.8
OPP1008XL	XL	30.8 - 35.9

Note: Measure circumference just above ankle bone.

- Provides comfortable compression for weak or overstressed ankles
- Relieves pain due to strains or stiffness



McDavid A431 Slip-On Thermal Ankle Support

- A general purpose slip-on neoprene ankle support
- Provides all the benefits of thermal compression

DVA: RAP# AR01 For more information please refer to pg 7.

Code	Size	Shoe Size
NHA431 1	S	37 - 40
NHA431 2	M	40.5 - 42.5
NHA431 3	L	43 - 45
NHA431 4	XL	45.5+

Note: Sizing by European shoe size.



McDavid A432 Thermal Ankle Support w/straps

- Thermal slip-on ankle support with 2 orthopaedic elasticised (figure 8) adjustment straps for graduated support
- Provides thermal compression with additional outer support
- Lined both sides
- Outer lining is made of heavy duty nylon for greater durability

DVA: RAP# AR01 For more information please refer to pg 7.

Code	Size	Shoe Size
NHA432 1	S	37 - 40
NHA432 2	M	40.5 - 42.5
NHA432 3	L	43 - 45
NHA432 4	XL	45.5+

Note: Fit according to shoe size (European metric).

- Protects and supports without restriction
- Fits left or right



Oppo 2004 Slip-On Adj Elastic Ankle Support

- Ideal for weak or unstable ankles, sprains, strains, or twisting injuries
- Provides firm support to the ankle joint with gentle compression
- Increases circulation to relieve pain, speed healing and maintain flexibility
- 35% cotton blend

DVA: RAP# AR01 For more information please refer to pg 7.

Code	Size	Shoe Size
OPP2004S	S	15.6 - 21.0
OPP2004M	M	21.5 - 26.0
OPP2004L	L	26.5 - 31.0
OPP2004XL	XL	31.1 - 36.2

Note: Measure circumference just above ankle bone.



Oppo 2103 Slip-On Elastic Fig 8 Ankle Brace

- 85% cotton content
- Adjustable strap maintains desired compression
- Spiral design slips on easily and stays in place
- Figure 8 construction for compression and pain relief
- Excellent support for weak or injured ankle or arches

DVA: RAP# AR01 For more information please refer to pg 7.

Code	Size	(cm)
OPP2103S	S	17.8 - 20.3
OPP2103M	M	20.3 - 22.9
OPP2103L	L	22.9 - 25.4
OPP2103XL	XL	25.4 - 27.9

Note: Measure circumference just above ankle bone.

- Suitable for a variety of ankle conditions



Oppo 2204 Slip-On Adj Elastic Ankle Support

- Provides support and relieves pain from strains and sprains
- Helps minimise further injury

DVA: RAP# AR01 For more information please refer to pg 7.

Code	Size	(cm)
OPP2204S	S	15.6 - 21.0
OPP2204M	M	21.5 - 26.0
OPP2204L	L	26.5 - 31.0

Note: Measure circumference just above ankle bone.



Stromgren S355 Stirrup Lock Ankle Support

- Designed to conform to the ankle anatomy like tape, without the pain
- Provides solid support incorporating two heel lock & two forefront lock straps
- The straps extend until they are rigid, therefore achieving a taped ankle effect without tape
- The support is locked using Velcro closure enabling easy adjustment

DVA: RAP# AR01 For more information please refer to pg 7.

Code - Black	Code - White	Size	Shoe Size
NHS355 B1	NHS355 W1	S	37 - 40
NHS355 B2	NHS355 W2	M	40.5 - 42.5
NHS355 B3	NHS355 W3	L	43 - 45
NHS355 B4	NHS355 W4	XL	45.5+

Note: Sizing by European shoe size.

- Restricts inversion & eversion injuries
- No break-in time needed
- Not bulky in a shoe & washable



McDavid A433 Dual Strap Ankle Support

- A lightweight, breathable, pull on elastic anklet
- 2 orthopaedic elastic (figure 8) adjustable Velcro straps for graduated support
- Not bulky in a shoe
- Available in white only

✓ DVA: RAP# AR01 For more information please refer to pg 7.

Code	Size	Shoe Size
NHA4331	S	37 - 40
NHA4332	M	40.5 - 42.5
NHA4333	L	43 - 45
NHA4334	XL	45.5+

Note: Fit according to shoe size (European metric).



Body Assist 300 Elastic Ankle Brace

- A general purpose adjustable spiral lift elastic ankle brace
- Provides low level orthopaedic support & protection to painful, tired ankles
- Includes an adjustable closure to assist in simple application & allows variation to compression levels
- Retains some body warmth & can increase blood circulation
- Fits easily into standard footwear

✓ DVA: RAP# AR01 For more information please refer to pg 7.

Code	Size	Shoe Size
NH300 1	S	Up to 45
NH300 2	M	45 - 50
NH300 3	L	50 - 55
NH300 4	XL	55+

Note: Measure figure.8 circumference per illustration.



Body Assist 310 Slip-On Ankle Support

- A general purpose spiral lift elastic ankle brace
- Provides low level orthopaedic support & protection to painful, tired ankles
- Retains some body warmth & can increase blood circulation
- Fits easily into standard footwear

✓ DVA: RAP# AR01 For more information please refer to pg 7.

Code	Size	(cm)
NH310 1	S	Up to 45
NH310 2	M	45 - 50
NH310 3	L	50 - 55
NH310 4	XL	50+

Note: Measure figure 8 circumference per illustration.



Body Assist 35 Slip-On Basic Ankle

- A general purpose, tubular design support
- Provides low level support & some protection to painful, tired ankles
- Retains body warmth & can increase blood circulation around the ankle
- Fits easily into standard footwear

✓ DVA: RAP# AR01 For more information please refer to pg 7.

Code - Black	Code - Beige	Size	Shoe Size
NH35 01	NH35B1	S	Up to 45
NH35 02	NH35B2	M	45 - 50
NH35 03	NH35B3	L	50 - 55
NH35 04	NH35B4	XL	55+

Note: Measure figure.8 circumference per illustration.



McDavid A511 Slip-On Elastic Ankle Support

- Tight weave basic tubular support
- Provides low level support & delivers protection to painful, tired ankles
- Retains some body warmth & can increase blood circulation

✓ DVA: RAP# AR01 For more information please refer to pg 7.

Code	Size	Shoe Size
NHA511 1	S	37 - 40
NHA511 2	M	40.5 - 42.5
NHA511 3	L	43 - 45
NHA511 4	XL	45.5+

Note: Fit according to shoe size (European metric).



Air Lite 4009 Ankle Brace

- Two rigid plastic shells have dual air layers over cushioning foam
- Air is allowed to flow within the air bladder to help reduce swelling
- Heel strap is adjustable to fit a range of sizes, and two adjustable swivel straps ensure proper placement each time
- Limits inversion/eversion while permitting near-normal flexion

DVA: RAP# AR01 For more information please refer to pg 7.

Code	Description	Size	Shoe Size
4009 M	Air Lite 4009 ankle brace Medium	M	40 - 41
4009 L	Air Lite 4009 ankle brace Large	L	42 - 44

Note: Fit according to shoe size (European metric).

- The brace designed for active people resuming activity from an acute ankle sprain



Oppo 4006 Ankle Brace

- Available with a unique heel-lock strapping system
- Nylon figure 8 straps will not stretch during exercise
- Fully adjustable even while in use
- Breathable lightweight fabric enhances comfort by allowing heat and moisture to escape throughout the brace
- Padded heel and tongue fabric is durable and provides added comfort
- May be used for left or right foot

DVA: RAP# AR01 For more information please refer to pg 7.

Code	Description	Size	Shoe Size
OPP4006S	Oppo 4006 ankle brace Small	S	40 - 42
OPP4006M	Oppo 4006 ankle brace Medium	M	43 - 45
OPP4006L	Oppo 4006 ankle brace Large	L	46 - 48
OPP4006XL	Oppo 4006 ankle brace Extra Large	XL	49 - 51

Note: Sizing by European shoe size.

- May be used for either therapeutic or prophylactic support of the ankle
- Easy lace-up application eliminates taping



Oppo 4106 Ankle Brace w/strap

- Non-stretch nylon figure 8 straps provide superior support for maximum protection
- Easy lace-up application eliminates tedious taping
- Flexible spring stays offer additional support without restricting movement
- Helps prevent inversion and eversion and controls rotational sprains
- May be used for left or right foot

DVA: RAP# AR01 For more information please refer to pg 7.

Code	Description	Size	Shoe Size
OPP4106S	Oppo 4106 ankle brace w/ strap Small	S	40 - 42
OPP4106M	Oppo 4106 ankle brace w/ strap Medium	M	43 - 45
OPP4106L	Oppo 4106 ankle brace w/ strap Large	L	46 - 48
OPP4106XL	Oppo 4106 ankle brace w/ strap Extra Large	XL	49 - 51

Note: Sizing by European shoe size.



Oppo 4005 Total Stability Ankle Brace

- Unique heel-lock strapping system
- Non-stretch figure 8 straps provide firm stability to an injured ankle, preventing inversion and eversion sprains
- Removable bilateral plastic splints for additional support
- Padded heel and tongue fabric is durable and provides added comfort

DVA: RAP# AR01 For more information please refer to pg 7.

Code	Description	Size	Shoe Size
OPP4005S	Oppo 4005 Total stability ankle brace Small	S	40 - 42
OPP4005M	Oppo 4005 Total stability ankle brace Medium	M	43 - 45
OPP4005L	Oppo 4005 Total stability ankle brace Large	L	46 - 48
OPP4005XL	Oppo 4005 Total stability ankle brace Extra Large	XL	49 - 51

Note: Sizing by European shoe size.



McDavid A101 Ankle Guard

- Suitable for those returning from injury or requiring on-going support
- Medical inserts can be removed if desired, although in place they provide additional support & protection
- Replaces costly tape & supports sprained or weak ankles
- Sewn in spring steel medical stays & an elastic heel inset for achilles tendon support
- Fits right or left foot & fully washable

DVA: RAP# AR01 For more information please refer to pg 7.

Code - Black	Code - White	Size	Shoe Size
NHA101BX	NHA101WX	XXS	Up to 37
NHA101B0	NHA101W0	XS	37.5 - 38.5
NHA101B1	NHA101W1	S	39 - 40
NHA101B2	NHA101W2	M	40.5 - 42.5
NHA101B3	NHA101W3	L	43 - 45
NHA101B4	NHA101W4	XL	45.5+

Note: Fit according to shoe size (European metric).

- Notched front allows more free plantar & dorsi flexion



McDavid A195 Ultralight Ankle Brace

- Ultra light nylon laceup with fully adjustable figure 8 straps
- Conforms to & supports sprained or weak ankles
- Stirrup straps restrict inversion & eversion injury & simulate costly tape
- Straps fully adjustable without removing shoes or re-lacing
- Elastic heel delivers Achilles tendon support

✓ DVA: RAP# AR01 For more information please refer to pg 7.

Code - Black	Code - White	Size	Shoe Size
NHA195B0	NHA195W0	XS	37.5 - 38.5
NHA195B1	NHA195W1	S	39 - 40
NHA195B2	NHA195W2	M	40.5 - 42.5
NHA195B3	NHA195W3	L	43 - 45
NHA195B4	NHA195W4	XL	45.5+

Note: Fit according to shoe size (European metric).



McDavid A199 Lightweight Laced Ankle Brace

- This lightweight version of a laced ankle brace is equally designed to conform to the ankle anatomy & to restrict inversion & eversion (rolling of the ankle)
- Includes sewn in spring steel medical stays & consists of two layers of vinyl/ nylon material
- Elastic heel achieves excellent results in supporting the achilles tendon
- Unique lining wicks perspiration away

✓ DVA: RAP# AR01 For more information please refer to pg 7.

Code - Black	Code - White	Size	Shoe Size
NHA199B0	NHA199W0	XS	37.5 - 38.5
NHA199B1	NHA199W1	S	39 - 40
NHA199B2	NHA199W2	M	40.5 - 42.5
NHA199B3	NHA199W3	L	43 - 45
NHA199B4	NHA199W4	XL	45.5+

Note: Fit according to shoe size (European metric).

- Notched front allows more free plantar & dorsi flexion movement



McDavid A189 Ankle - X Hinged Ankle Brace

- Ankle brace that offers a high level of protection & comfort for athletes of all ages
- Consists of a neoprene sleeve worn inside the rigid component
- Makes this brace very comfortable
- Pivot Hinges
- Lightweight

✓ DVA: RAP# AR01 For more information please refer to pg 7.

Code	Description	Size	Shoe Size
NHA189R1	McDavid A189 Ankle-X hinged Medium	M	41 - 44
NHA189R3	McDavid A189 Ankle-X Large/Extra Large	L/XL	45+

Note: Fit according to shoe size (European metric).

- Manoeuverability not restricted
- Very effective for high ankle sprains



McDavid A188G Ultra Graphite Hinged Ankle

- Ankle support taken to a new level
- Made to the highest professional quality, this hinged ankle brace is designed to treat all ankle injuries (including high ankle sprains)
- Engineered to reduce excessive inversion, eversion and rotation ankle injuries
- Fully Padded & very quick to apply (no laces)

✓ DVA: RAP# AR01 For more information please refer to pg 7.

Code	Size	Shoe Size
NHA188G1	S	Up to 40
NHA188G2	M	41 - 44
NHA188G3	L	45+

Note: Fit according to shoe size (European metric).

- Ideal for rehab or as injury prevention
- Works well with foot beds & orthotics
- Universal fitting for Left or Right



Oppo 1205 Ankle Guard '3'

- Reinforced exoskeleton is designed to fit ankle and foot contour, and axis of subtalar joint. It stabilizes the ankle in case of ankle sprain or ankle joint instability, and provides stable support from the distal tibia and fibula bone to the ankle during impact and sudden twist and prevents injury when running or jumping
- Plastic exoskeleton worn inside shoes controls the motion of plantarflexion during daily activity

✓ DVA: RAP# AR01 For more information please refer to pg 7.

Code	Size	(cm)
OPP1205S	S	15.6 - 20.6
OPP1205M	M	20.6 - 25.7
OPP1205L	L	25.7 - 30.8
OPP1205XL	XL	30.8 - 35.9

Note: Measure circumference just above ankle bone.

- Biomechanical design centralizes compression to maintain ankle in an ideal position during walking and running, to reduce the possibility of ankle sprain, or the severity of ankle injury as a result of heel instability



Cosmac Post-Operative Shoes

- Tnylon-mesh upper lined with cushioning foam for comfort
- Adjustable hook closure ensures correct fit
- Reinforced heel cup and shock-absorbent inner sole
- Fits left or right foot
- Shoe size: metric

DVA: RAP# AJ06 For more information please refer to pg 7.

Code - Male	Size	Shoe Size
CF701 93	S	Up to 40
CF701 95	M	40 - 43
CF701 97	L	44 - 46
CF701 99	XL	46+
Code - Female	Size	Shoe Size
CF701 83	S	Up to 36
CF701 85	M	37 - 39
CF701 87	L	40+

Note: Fit according to shoe size (European metric).



Darco All Purpose Boot

- Rocker Sole reduces plantar pressure under forefoot and heel by over 25%
- Square Toe Design acts as a bumper to protect the toes when k-wires are present and provides better Left/Right fitankle Strap seats foot firmly in shoe to reduce heel slippage and eliminate friction
- Insole can be totally removed to accommodate DARCO's innovative Peg Assist™ customizable off-loading insole (product code DA-PQ)

DVA: RAP# AJ06 For more information please refer to pg 7.

Code	Size	Female Shoe Size	Male Shoe Size
DA-APQ-0B	XS	4 - 7	
DA-APQ-1B	S	7.5 - 10	6 - 8
DA-APQ-2B	M	10.5 - 13	8.5 - 10
DA-APQ-3B	L	13+	10.5 - 12
DA-APQ-4B	XL		12.5 - 14

Note: Sizing by US shoe size.

- Removable Forefoot Closure provides security while eliminating buckle pressure



Darco Heelwedge Shoe

- Effective off-loading Footwear
- Reduces Heel pressure by over 26%
- Square Toe Design acts as a bumper to protect the toes and provides better universal left/right fit
- Ankle Strap seats foot firmly in shoe to reduce heel slippage and eliminate friction
- Zoned Outsole has an aggressive tread under the mid-foot where traction is needed most

DVA: RAP# AJ06 For more information please refer to pg 7.

Code	Size	Female Shoe Size	Male Shoe Size
DA-HQ-0B	XS	4 - 7	
DA-HQ-1B	S	7.5 - 10	6 - 8
DA-HQ-2B	M	10.5 - 13	8.5 - 10
DA-HQ-3B	L	13+	10.5 - 12
DA-HQ-4B	XL		12.5 - 14

Note: Sizing by US shoe size.

- Insole can be totally removed to accommodate DARCO's innovative Peg Assist™ customizable off-loading insole for an even more targeted off-load (product code DA-PQ)



Darco Med Surg Shoe

- Square Toe Design acts as a bumper to provide extra protection and facilitates better left/right fit
- MetaShank™ protection provides more rigid control under the metatarsal heads
- Rocker Sole reduces plantar pressure on the heel and forefoot by over 25%
- Fully compatible with DARCO's Peg-Assist™ off-loading insole (product code DA-PTQ)

DVA: RAP# AJ06 For more information please refer to pg 7.

Code - Male	Size	Shoe Size
DA-MQM-1B	S	6 - 8
DA-MQM-2B	M	8.5 - 10
DA-MQM-3B	L	10.5 - 12
DA-MQM-4B	XL	12.5 - 14
Code - Female	Size	Shoe Size
DA-MQW-1B	S	4 - 6
DA-MQW-2B	M	6.5 - 8
DA-MQW-3B	L	8.5 - 10

Note: Sizing by US shoe size.



Darco Orthowedge Shoe

- 15° Wedge Sole effectively shifts body weight to the midfoot and heel
- Reduces forefoot pressure by as much as 57%
- Square Toe Design acts as a bumper to protect the toes when k - wires are present and provides better Left/Right fit
- Insole can be totally removed to accommodate DARCO's innovative Peg Assist™ customizable off-loading insole (product code DA-PQ)

DVA: RAP# AJ06 For more information please refer to pg 7.

Code	Size	Female Shoe Size	Male Shoe Size
DA-OQ-0B	XS	4-7	
DA-OQ-1B	S	7.5-10	6 - 8
DA-OQ-2B	M	10.5-13	8.5 - 10
DA-OQ-3B	L	13+	10.5 - 12
DA-OQ-4B	XL		12.5 - 14

Note: Sizing by US shoe size.

- Zoned Outsole has an aggressive tread under the mid-foot where traction is needed most



Darco Soffie Shoe

- Economical, post-op shoe indicated for soft tissue trauma or surgery
- Semi-rigid metatarsal shank provides control of forefoot motion
- Tissue friendly upper material conforms to bony abnormalities and is breathable
- Easy to fasten hook and loop straps

✓ DVA: RAP# AJ06 For more information please refer to pg 7.

Code - Male	Size	Shoe Size
DA-STM-1B	S	6.0 - 8.0
DA-STM-2B	M	8.5 - 10.0
DA-STM-3B	L	10.5 - 12.0
DA-STM-4B	XL	12.5 - 14.0
Code - Female	Size	Shoe Size
DA-STW-1B	S	4 - 6
DA-STW-2B	M	6.5 - 8.0
DA-STW-3B	L	8.5 - 10.0

Note: Sizing by US shoe size.



Cosmac Cast Shoe

- Curved 'rocker' sole for easy ambulation
- Canvas upper with velcro closures at front and back
- Fits left or right foot

✓ DVA: RAP# AJ06 For more information please refer to pg 7.

Code	Description	Size	Shoe Length(cm)
CF6306 S	Cosmac cast shoe Small	S	23
CF6306 M	Cosmac cast shoe Medium	M	27
CF6306 L	Cosmac cast shoe Large	L	32

Note: Sizing by US shoe size.



Darco Body Armor Cast Shoe

- Ultimate cast protection in a new modern design that will appeal to all patients
- Soft but durable EVA provides shock absorption while protecting the cast from the elements
- Unique bungee closure system is easy to use, easy to adjust and prevents the heel from slipping out of the cast shoe

✓ DVA: RAP# AJ06 For more information please refer to pg 7.

Code	Size	Female Shoe Size	Male Shoe Size
DA-BACS-0	XS	Up to 5	
DA-BACS-1	S	5.5 - 8	
DA-BACS-2	M	8.5 - 10	6 - 8
DA-BACS-3	L	10.5 - 13	8.5 - 11
DA-BACS-4	XL	13.5+	11.5 - 14

- Soft, durable TPR
- Unique bungee closure system to seat and secure the cast in the shoe

Note: Sizing by US shoe size.



Darco Slimline Cast Boot

- Be adapted to fiberglass casts, bulky compression bandages and a variety of woundcare applications, making it one of the most versatile cast shoes on the market
- Forefoot Closure can be adjusted to accommodate casts or bandages and can be switched between left/right closure
- Higher Ankle Strap adds stability

✓ DVA: RAP# AJ06 For more information please refer to pg 7.

Code	Size	Female Shoe Size	Male Shoe Size
DA-SLQ-0B	XS	Up to 5	
DA-SLQ-1B	S	5.5 - 8	
DA-SLQ-2B	M	8.5 - 10	6 - 8
DA-SLQ-3B	L	10.5 - 13	8.5 - 11
DA-SLQ-4B	XL	13.5+	11.5 - 14

Note: Sizing by US shoe size.

- Rocker Sole allows for a smooth roll throughout the gait pattern



Standard Walker with Fixed Ankle

- Contoured strut design allows the walker frame to conform to the wearer's anatomy ensuring a better fit
- Shock absorbing sole reduces impact from the heel strike to improve comfort during ambulation
- Low and wide rocker bottom helps promote a natural gait and stability

✓ DVA: RAP# AR19 For more information please refer to pg 7.

Code	Description	Size	Shoe Size
OPP30091	Standard walker with fixed ankle Small	S	37 - 39
OPP30092	Standard walker with fixed ankle Medium	M	40 - 43
OPP30093	Standard walker with fixed ankle Large	L	44 - 46
OPP30094	Standard walker with fixed ankle Extra Large	XL	46 - 48

Note: Sizing by European shoe size.



Standard Walker with ROM Hinge

- Contoured strut design allows the walker frame to conform to the wearer's anatomy ensuring a better fit
- Shock absorbing sole reduces impact from the heel strike to improve comfort during ambulation
- Low and wide rocker bottom helps promote a natural gait and stability
- ROM design gives ability to set ankle at various angles

DVA: RAP# AR19 For more information please refer to pg 7.

Code	Description	Size	Shoe Size
OPP31081	Standard walker with ROM hinge Small	S	37 - 39
OPP31082	Standard walker with ROM hinge Medium	M	40 - 43
OPP31083	Standard walker with ROM hinge Large	L	44 - 46
OPP31084	Standard walker with ROM hinge Extra Large	XL	46 - 48

Note: Sizing by European shoe size.



Air Walker with Fixed Ankle

- This air walker has a rocker sole and low profile heel to facilitate a more natural gait pattern
- Adjustable air cells increase stability while decreasing pain and swelling

DVA: RAP# AR19 For more information please refer to pg 7.

Code	Description	Size	Shoe Size
OPP32091	Air Walker with fixed ankle Small	S	37 - 39
OPP32091	Air Walker with fixed ankle Medium	M	40 - 43
OPP32091	Air Walker with fixed ankle Large	L	44 - 46
OPP32091	Air Walker with fixed ankle Extra Large	XL	46 - 48

Note: Sizing by European shoe size.



Air Walker with ROM Hinge

- Cross-strapping provides firm support and stabilisation for injured ankles
- The rocker bottom provides more walking stability during rehabilitation
- Extra pads help to increase comfort, providing stability and firm support for an injured ankle
- Inflatable air liner for custom fit and support
- Settings from 45° plantar flexion and 30° dorsi-flexion in 7.5° increments

DVA: RAP# AR19 For more information please refer to pg 7.

Code	Description	Size	Shoe Size
OPP31091	Air Walker with ROM hinge Small	S	37 - 39
OPP31092	Air Walker with ROM hinge Medium	M	40 - 43
OPP31093	Air Walker with ROM hinge Large	L	44 - 46
OPP31094	Air Walker with ROM hinge Extra Large	XL	46 - 48

Note: Sizing by European shoe size.

- Uprights can be locked in fixed position of 0°, 7.5°, 15°, 22.5° or 30° plantar flexion and dorsi-flexion



Drop Foot Ankle Foot Orthosis Open

- Limits plantar flexion, common peroneal nerve injuries
- Full length sole
- Can be adjusted for a custom fit by heating, cutting and grinding
- Available in left or right fitting

DVA: RAP# AR19 For more information please refer to pg 7.

Code - Left	Code - Right	Size	Female Shoe Size	Male Shoe Size
AUPHYAFOXS-L	AUPHYAFOXS-R	XS	4 - 6	4 - 5
AUPHYAFOS-L	AUPHYAFOS-R	S	6 - 8	5 - 7
AUPHYAFOM-L	AUPHYAFOM-R	M	8 - 10	7 - 9
AUPHYAFOL-L	AUPHYAFOL-R	L	10 - 13	9 - 12

Note: Sizing by US shoe size.



Drop Foot Ankle Foot Orthosis

- Designed to hold the foot correctly
- Supports the foot to stop dragging
- Fits easily into shoe, heat mouldable, easily trimmed

DVA: RAP# AR19 For more information please refer to pg 7.

Code - Left	Code - Right	Size	Shoe Size
B770L S	B770R S	S	Up to 38
B770L M	B770R M	M	39 - 43
B770L L	B770R L	L	44 - 46
B770L XL	B770R XL	XL	47+

Note: Sizing according to European (metric) shoe size.



Valgus 4050 Arch/ Metatarsal Support

- Anatomically designed moulded rubber with leather cover
- Metatarsal dome
- Available in narrow and wide fittings
- Order by shoe size (metric) and width
- Supplied in pairs

✓ DVA: RAP# AR04 For more information please refer to pg 7.

Code - Narrow	Code - Wide	Shoe Size	Code - Narrow	Code - Wide	Shoe Size
B1801/100/33		33	B1801/100/40	B1801/200/40	40
B1801/100/34		34	B1801/100/41	B1801/200/41	41
B1801/100/35		35	B1801/100/42	B1801/200/42	42
B1801/100/36		36		B1801/200/43	43
B1801/100/37		37		B1801/200/44	44
B1801/100/38	B1801/200/38	38		B1801/200/45	45
B1801/100/39	B1801/200/39	39		B1801/200/46	46

Note: Sizing according to European (metric) shoe size.



Metatarsal 1920 Support

- Thin, flat leather support with wide metatarsal support
- Order by shoe size (metric)
- Supplied in pairs

✓ DVA: RAP# AR04 For more information please refer to pg 7.

Code	Shoe Size (European)	Code	Shoe Size (European)
B1920/35	35	B1920/41	41
B1920/36	36	B1920/42	42
B1920/37	37	B1920/43	43
B1920/38	38	B1920/44	44
B1920/39	39	B1920/45	45
B1920/40	40	B1920/46	46

Note: Sizing according to European (metric) shoe size.



Tulis 740 Standard Heel Cups

- Double ribbed classic heel cups provide relief from
- Heel strike
- Worn in shoes
- Available as pairs
- Size by weight (kg)

✓ DVA: RAP# AR04 For more information please refer to pg 7.

Code	Description	Size	Sizing: weight (kg)
B740 R	Tulis 740 standard heel cups Regular	Regular	under 80
B740 L	Tulis 740 standard heel cups Large	Large	over 80

Note: Sizing according to weight (kg).



Tulis 741 Heavy Duty Heel Cups

- Double ribbed heavy duty heel cups
- Two level rib pattern for higher level shock absorption
- Per pair
- Size by weight (kg)
- Small size for young athletes

✓ DVA: RAP# AR04 For more information please refer to pg 7.

Code	Description	Size	Sizing: weight (kg)
B741 S	Tulis 741 heavy duty heel cups Small	S	Up to 40
B741 R	Tulis 741 heavy duty heel cups Medium	M	40 - 80
B741 L	Tulis 741 heavy duty heel cups Large	L	Over 80

Note: Sizing according to weight (kg).



Tulis 743 Fatigue Mats

- TuliGEL Heel Fatigue Mats are the ideal protection when a lowprofile shock absorber is needed
- Slipping smoothly into the heel of the shoe TuliGEL Heel Fatigue Mats have the same protective design as TULI'S Heel Cups
- Universal (one size fits all)

✓ DVA: RAP# AR04 For more information please refer to pg 7.

Code	Description	Size
B743	Tulis 743 fatigue mats	Universal Size



Tulis 744 Metatarsal Cushions

- For protection during normal daily routines
- Waffle design assists in pain relief when wearing fashion or dress shoes
- Constructed of high impact TuliGEL
- Per pair
- One size fits all

✓ DVA: RAP# AR04 [For more information please refer to pg 7.](#)

Code	Description	Size
B744	Tulis 744 metatarsal cushions	Universal Size



Tulis 745 Heel Fatigue Mats

- Personal Fatigue Mats have been scientifically and medically designed to protect feet from hard, unyielding surfaces
- The unique tic-tac-toe soft waffle pattern interrupts the shock waves created while walking or running, helping to prevent fatigue, tired, swollen, aching feet and backache
- Universal (one size fits all)

✓ DVA: RAP# AR04 [For more information please refer to pg 7.](#)

Code	Description	Size
B745	Tulis 745 heel fatigue mats	Universal size

- If you work on hard concrete surfaces, TuliGEL Personal Fatigue Mats can make a real difference in how you feel



Tulis 107 Diamondbacks Heel/Arch Supports

- A very comfortable heel and arch support
- Combination of soft gel with a supportive foam arch
- Thin, easy-fitting design
- Will fit most shoe styles, including dress shoes

✓ DVA: RAP# AR04 [For more information please refer to pg 7.](#)

Code	Size	Female Shoe Size	Male Shoe Size
B107 S	S	5 - 7	3 - 5
B107 R	M	8 - 11	6 - 9
B107 L	L	12 - 16	10 - 14

Note: Sizing by US shoe size.



Heel Spur Heel Cups

- Silicone Medical Gel provide exceptional heel support, protection & comfort
- Ideal for sports use, gardening, factory staff, construction workers, office staff & for people who stand on hard surfaces
- G.C. Heel Spur Pads are made from a unique Medical Silicone Gel compound that assists to dissipate shock & shear, caused by impact to the heel & foot
- They emulate the fatty tissue, usually found on the underfoot

✓ DVA: RAP# AR04 [For more information please refer to pg 7.](#)

Code	Size	Shoe Size
NHGC66HC 1	S	37- 40
NHGC66HC 2	M	40.5 - 42
NHGC66HC 3	L	42.5+

Note: Sizing by European shoe size.

- Damaging stress forces normally absorbed by the body's musculo-skeletal system, are now absorbed by the pad & away from the body



Heel Spur Pads

- These Heel Spur Pads gently cushion the heel, while dissipating shock and shear generated by heel strike
- A removable 'tear drop' central plug allows the heel centre to be suspended around a supportive ring of silicone gel
- The pads fit snugly into the heel of a shoe
- Shock attenuation properties of this material have been proven effective in modifying heel strike trauma

✓ DVA: RAP# AR04 [For more information please refer to pg 7.](#)

Code	Size	Shoe Size
NHGC66SP 1	S	Up to 38
NHGC66SP 2	M	38.5 - 42
NHGC66SP 3	L	42.5+

Note: Sizing by European shoe size.



Gel Shoe Insole

- Provides overall support, protection, comfort & help reduce painful shock waves to the body & lighten the load on joints
- Ideal for sports use, gardening, factory staff, construction workers, office staff & for people who stand on hard surfaces
- Made from a unique Medical Silicone Gel compound that assists to dissipate shock & shear, caused by impact to the heel & foot
- Suitable for managing minor cases of splayfoot

✓ DVA: RAP# AR04 For more information please refer to pg 7.

Code	Size	Shoe Size
NHGC66FB 0	XS	37 - 38
NHGC66FB 1	S	39 - 41
NHGC66FB 2	M	41 - 43
NHGC66FB 3	L	44 - 46
NHGC66FB 4	XL	47+

Note: Sizing by European shoe size.

- Damaging stress forces normally absorbed by the body's musculo-skeletal system, are now absorbed by the footbeds & away from the body



Trio Heel Elevators

- Trio elevators come in different heights and should be placed under the heel area of the orthotic
- Choose between sizes small, medium, or large
- They are manufactured from extra firm density to prevent wearing out or crushing
- Available in 4, 6 and 8mm rises

✓ DVA: RAP# AR04 For more information please refer to pg 7.

Code - 4mm	Code - 6mm	Code - 8mm	Size	Shoe Size
TALHE 4S	TALHE 6S	TALHE 8S	S	Up to 37
TALHE 4M	TALHE 6M	TALHE 8M	M	38 - 43
TALHE 4L	TALHE 6L	TALHE 8L	L	44+

Note: Sizing by European shoe size.



Darco Peg-Assist

- Designed for use in most DARCO square-toe shoes, other than the DARCO Med-Surg Shoe (for which DA-PTQ Insoles should be used)
- Removable pegs allow for localized off-loading of wounds and ulcerations of the foot
- Pressure reduced by as much as 60% while allowing patient to remain ambulatory

✓ DVA: RAP# AR04 For more information please refer to pg 7.

Code	Size	Female Shoe Size	Male Shoe Size
DA-P- 0	XS	Up to 5	
DA-PQ-1	S	5.5 - 8	
DA-PQ-2	M	8.5 - 10	6 - 8
DA-PQ-3	L	10.5 - 13	8.5 - 11
DA-PQ-4	XL	13.5+	11.5 - 14

Note: Sizing by US shoe size.

- Poron® cover eliminates the incidence of ring edema and edge abrasion



Darco Peg-Assist Insole

- Designed for use with the DARCO Med-Surg Shoe
- Removable pegs allow for localised off-loading of wounds and ulcerations of the foot
- Pressure reduced by as much as 60% while allowing patient to remain ambulatory
- Poron® cover eliminates the incidence of ring edema and edge abrasion

✓ DVA: RAP# AR04 For more information please refer to pg 7.

Code - Male	Size	Shoe Size
DA-PTQ-M1	S	6 - 8
DA-PTQ-M2	M	8.5 - 10
DA-PTQ-M3	L	10.5 - 12
DA-PTQ-M4	XL	12.5 - 14
Code - Female	Size	Shoe Size
DA-PTQ-W1	S	4 - 6
DA-PTQ-W2	M	6.5 - 8
DA-PTQ-W3	L	8.5 - 10

Note: Sizing by US shoe size.



Oppo 1408 Achilles Brace w/silicone Pad

- The concentric ripples on the pad provide intermittent massage - like compression, to effectively reduce edema, relieve spasm and speed up the recovery process
- CoolPrene® material provides shock absorption, dynamic compression and better breathability on the injured ankle over prolonged use

✓ DVA: RAP# AR02 For more information please refer to pg 7.

Code - Left	Code - Right	Size	Shoe Size (metric)
OPP1408 S-L	OPP1408 S-R	S	15.6 - 20.6
OPP1408 M-L	OPP1408 M-R	M	20.6 - 25.7
OPP1408 L-L	OPP1408 L-R	L	25.7 - 30.8
OPP1408 XL-L	OPP1408 XL-R	XL	30.8 - 35.9

Note: Measure circumference just above ankle bone.

- The butterfly shaped pad is anatomically designed to fit the achilles tendon and provide support during motion



McDavid A436 Achilles Tendon Strap

- Applies constant mild compression at the achilles tendon through the use of a unique tubular buttress
- Helps relieve some dynamic forces caused by constant running & jumping
- Adjustable 2 way stretch neoprene strap with hook and loop closure

✓ DVA: RAP# AR02 For more information please refer to pg 7.

Code	Description	Size	cm
NHA4361	McDavid A436 achilles tendon strap Small/Medium	S/M	Up to 10
NHA4363	McDavid A436 achilles tendon strap Large/Extra Large	L/XL	10+

Note: Sizing by US shoe size.



Achilles 1400 Heel Protection Sleeve

- The soft, comfortable gel pad protects the posterior of the heel from friction while gently compressing and reducing pressure
- Washable and reusable
- Slim profile design fits most footwear

✓ DVA: RAP# AR02 For more information please refer to pg 7.

Code	Description	Size
AUGEL1400M	Achilles 1400 heel protection sleeve	One size (Small/Medium)



Adjustable Night Splint

- Patented Formfit 3D molded technology allows for variable padding thickness in strategic locations for superior comfort and fit
- Soft lycra lined foam interior is plush and breathable, eliminating heat build-up
- Three lycra lined foam padded straps with user friendly centre release buckles ensure immobilisation while maintaining comfort across the flexor tendons

✓ DVA: RAP# AR02 For more information please refer to pg 7.

Code	Size	Female Shoe Size	Male Shoe Size
AUPHYNSP S	S	Up to 7.5	Up to 7
AUPHYNSP M	M	8 - 10.5	7.5 - 10
AUPHYNSP L	L	11+	10.5+

- Adjustable dorsi-flexion straps provide a gentle stretching of the plantar fascia and achilles tendon (adjustable from 90 to 10 degrees dorsi-flexion)



Hallux Valgus 510 Night Strap

- A light and flexible strap to unload the joints of the big toe
- Especially designed for nightly or post-operative usage
- Padded with skin-caring and breathable material
- Provides pain relief and guides the big toe
- Universal size - specify left or right foot

✓ DVA: RAP# AR02 For more information please refer to pg 7.

Code - Left	Code - Right	Size
REH510 L	REH510 R	Universal size



Hallux Valgus 509 Day Strap

- A light and flexible strap to unload the joints of the big toe
- Padded for optimal comfort
- Can be used with or without shoes
- Gives pain relief and may be a condition for a normalised function of the muscles, guides the big toe
- Universal size - specify left or right foot

✓ DVA: RAP# AR02 For more information please refer to pg 7.

Code - Left	Code - Right	Size
REH509L	REH509R	Universal size



Darco Toe Alignment Splint

- Low profile metatarsal band fits easily into most footwear and reduces slippage
- Soft toe straps will not irritate skin
- Special T-Strap gently guides toe(s) into proper alignment for post-procedural healing
- One sizes fits all
- Latex Free
- Colour - White

 DVA: RAP# AR02 For more information please refer to pg 7.

Code	Description	Size
DA-TAS	Darco toe alignment splint	Universal size



Dale Abdominal Binder

- Single ply stretch loop elastic (latex-free)
- Velcro closure anywhere on belt for perfect fit
- Provides full, even pressure and aids abdominal muscle
- Colour white
- Sizing: available in either 23cm (pictured) or 30cm widths, both in S, M and L sizes

DVA: RAP# AR08 For more information please refer to pg 7.

23 cm wide 3 - panel Code	30 cm wide 3 - panel Code	Size	Circum. (cm)
DO 410	DO 810	S	Up to 114
DO 411	DO 811	M	114 - 157
DO 418	DO 818	L	152 - 191

Sizing: measure circumference of waist.



Scudotex 644 Elastic Hernia Underpants w/Pads

- Designed with special highly compressive fabric
- Anatomical shape ensures support for the abdominal area to prevent muscle prolapse and provide a balanced inguinal compression
- Foam pads fit into pockets to support inguinal hernia

DVA: RAP# AR14 For more information please refer to pg 7.

Code	Size	Waist	Hip
SCTX644 3	M	80 - 86	90 - 98
SCTX644 4	L	86 - 92	96 - 104
SCTX644 5	XL	92 - 99	102 - 111
SCTX644 6	XXL	99 - 106	109 - 118
SCTX644 7	XXXL	106 - 114	116 - 126

Measure hip and waist circumference (cm).



Scudotex 609 Hernia Support Belt w/Pads

- Inguinal truss with anatomic protective front in hygienic elastic and cotton fabric
- Adjustable leg straps go under the thighs and attach at the back to allow correct inguinal compression
- Designed with two removable rubber pads covered with hygienic cotton
- Back adjustable opening

DVA: RAP# AR14 For more information please refer to pg 7.

Code	Size	(cm)
SCTX609 2	S	75 - 80
SCTX609 3	M	80 - 86
SCTX609 4	L	86 - 92
SCTX609 5	XL	92 - 99
SCTX609 6	XXL	99 - 106
SCTX609 7	XXXL	106 - 114
SCTX609 8	XXXXL	114 - 122

Measure waist circumference (cm).



Body Assist 590 Hernia Belt

- Removable foam pads
- Under leg straps
- Easy velcro fastening and adjustment
- Made of lightweight material construction & assists to inhibit skin irritation
- The belt can be worn whilst showering or swimming

DVA: RAP# AR14 For more information please refer to pg 7.

Code	Size	(cm)
NH590 0	XS	65 - 75
NH590 1	S	75 - 85
NH590 2	M	85 - 95
NH590 3	L	95 - 105
NH590 4	XL	105 - 115

Sizing: measure waist circumference (cm).



Scudotex 682 Inguinal Hernia Belt - Heavy Duty

- Quality inguinal truss in strong elastic
- Back adjustable
- Soft cotton edges for greater comfort
- Leather-covered pads
- Adjustable leg straps
- Double pads

DVA: RAP# AR14 For more information please refer to pg 7.

Code	Description	Size	Waist
SCTX682 2	Scudotex 682 Inguinal hernia belt - heavy duty S	S	75 - 80
SCTX682 3	Scudotex 682 Inguinal hernia belt - heavy duty M	M	80 - 86
SCTX682 4	Scudotex 682 Inguinal hernia belt - heavy duty L	L	86 - 92
SCTX682 5	Scudotex 682 Inguinal hernia belt - heavy duty XL	XL	92 - 99
SCTX682 6	Scudotex 682 Inguinal hernia belt - heavy duty XXL	XXL	99 - 106

Measure waist circumference (cm).



Barrere 24 Post-Op Inguinal Belt

- Heavy duty post-operative inguinal hernia support belt
- Same as model 25 - S, but with no pads fitted
- Therefore, no left/right fitting
- Two understraps ensure correct positioning

✓ DVA: RAP# AR14 For more information please refer to pg 7.

Code	Description	Size	(cm)
B24 XS	Barrere 24 post-op inguinal belt XS	XS	76 - 81
B24 S	Barrere 24 post-op inguinal belt S	S	81 - 86
B24 M	Barrere 24 post-op inguinal belt M	M	86 - 91
B24 L	Barrere 24 post-op inguinal belt L	L	91 - 96
B24 XL	Barrere 24 post-op inguinal belt XL	XL	96 - 101
B24 XXL	Barrere 24 post-op inguinal belt XXL	XXL	101 - 106

Sizing: measure circumference (cm) 5cm below the hips, with tape measure sloping down at the front towards the abdomen.



Barrere 25 - S Inguinal Hernia Belt

- Heavy duty hernia belt for all inguinal hernias
- Available in left, right or double
- Two understraps ensure correct positioning

✓ DVA: RAP# AR14 For more information please refer to pg 7.

Code	Description	Size	(cm)
B25 - SXS	Barrere 25 - S inguinal hernia belt XS	XS	76 - 81
B25 - SS	Barrere 25 - S inguinal hernia belt S	S	81 - 86
B25 - SM	Barrere 25 - S inguinal hernia belt M	M	86 - 91
B25 - SL	Barrere 25 - S inguinal hernia belt L	L	91 - 96
B25 - SXL	Barrere 25 - S inguinal hernia belt XL	XL	96 - 101
B25 - SXXL	Barrere 25 - S inguinal hernia belt XXL	XXL	101 - 106

Sizing: measure circumference (cm) 5cm below the hips, with tape measure sloping down at the front towards the abdomen.



Barrere 26 - S Scrotal Hernia Belt

- Available in left, right or double
- Two understraps ensure correct positioning
- With suspensory and double-adjustable crossover straps to ensure complete control of any size reducible hernia

✓ DVA: RAP# AR09 For more information please refer to pg 7.

Code	Description	Size	(cm)
B26 - S XS	Barrere 26 - S scrotal hernia belt XS	XS	76 - 81
B26 - S S	Barrere 26 - S scrotal hernia belt S	S	81 - 86
B26 - S M	Barrere 26 - S scrotal hernia belt M	M	86 - 91
B26 - S L	Barrere 26 - S scrotal hernia belt L	L	91 - 96
B26 - S XL	Barrere 26 - S scrotal hernia belt XL	XL	96 - 101
B26 - S XXL	Barrere 26 - S scrotal hernia belt XXL	XXL	101 - 106

Sizing: measure circumference (cm) 5cm below the hips, with tape measure sloping down at the front towards the abdomen.



McDavid A310 Athletic Support

- A multi-purpose supporter featuring a power-knit pouch with Intera for rapid drying and cooling
- Provides greater resistance to bacteria and mildew, and the odours and skin irritation they produce
- More comfortable than cotton or synthetics

✓ DVA: RAP# AR09 For more information please refer to pg 7.

Code	Size	(cm)
NHA310 1	S	66 - 82
NHA310 2	M	82 - 97
NHA310 3	L	97 - 112
NHA310 4	XL	112 - 128

Measure around waist (cm).

- Incorporates an 8cm knit waistband and 1cm leg straps
- High rubber content assures maximum support and durability



McDavid A321 Athletic Support with Protective Cup

- A durable and comfortable supporter featuring a plastic protector cup, enclosed in a power-knit pouch, with Intera for rapid drying and cooling
- Provides greater resistance to bacteria and mildew, and the odours and skin irritation they produce
- More comfortable than cotton or synthetics

✓ DVA: RAP# AR09 For more information please refer to pg 7.

Code	Description	Size	(cm)
NHA321 1	McDavid A321 athletic support with protective cup	S	66 - 82
NHA321 2	McDavid A321 athletic support with protective cup	M	82 - 97
NHA321 3	McDavid A321 athletic support with protective cup	L	97 - 112
NHA321 4	McDavid A321 athletic support with protective cup	XL	112 - 128

Measure around waist (cm).



Supreme Suspensory Lightweight

- Lightweight scrotal support
- Designed to hold and lift the scrotum
- Relieves the strain and fatigue of swollen or sagging testicles
- Opening for penis

✓ DVA: RAP# AR09 For more information please refer to pg 7.

Code	Description	Size	(cm)
ASO 13	Supreme Suspensory lightweight S	S	76 - 89
ASO 14	Supreme Suspensory lightweight M	M	89 - 104
ASO 15	Supreme Suspensory lightweight L	L	104 - 117
ASO 15XL	Supreme Suspensory lightweight XL	XL	117 - 130

Measure around waist (cm).



Truform 243 Suspensory - Heavy Duty

- For larger scrotal swelling/enlargement
- Heavy duty construction
- 4.5cm elastic web waistband with claw-buckle fastening.
- Strong mesh pouch
- 2cm elastic leg-straps
- Opening for penis
- Sized according to pouch
- Medium is the size most often selected

✓ DVA: RAP# AR09 For more information please refer to pg 7.

Code	Description	Size
TR243M	Truform 243 suspensory - heavy duty M	M
TR243L	Truform 243 suspensory - heavy duty L	L
TR243XL	Truform 243 suspensory - heavy duty XL	XL



TSL Scrotal Support - Extra Large

- For extreme scrotal swelling/enlargement provides support and patient comfort by alleviating heavy sensation
- Comfortable to wear
- Soft Powernet fabric

✓ DVA: RAP# AR09 For more information please refer to pg 7.

Code	Description	Size	Combined Scrotum Size
TSLSS 1	TSL Scrotal Support - extra large S	S	Orange
TSLSS 2	TSL Scrotal Support - extra large M	M	Rock melon
TSLSS 3	TSL Scrotal Support - extra large L	L	Watermelon

Aidacare Online

For all of your product enquiries in one user-friendly site visit us online at www.aidacare.com.au

- New product releases - updated daily
- Clear and concise product descriptions and specifications
- Contract specific ordering information (DVA, TAC & MASS)
- Downloadable DVA RAP and other order forms
- Full colour product images
- Information on our range of service offerings
- Newsletter subscription page

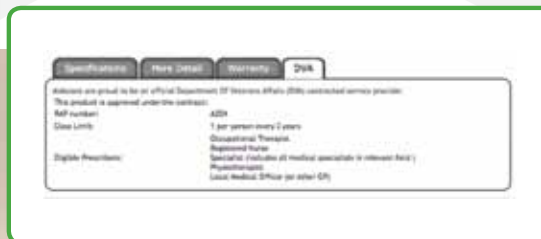

"We care for your care"



Walking Frames & Aids - Mobility



- P 295** Seat Walkers / Rollators & Accessories
- P 299** Walking Sticks & Accessories
- P 301** Crutches & Accessories
- P 303** General Accessories



Seat Walkers with Hand Brakes

- Provides assistance to those who need confidence walking and require rest en route
- Folds away for easy storage or transportation
- Height adjustable handles to suit user
- Handbrakes are lockable for stability
- Padded backrest for seating comfort
- Lightweight aluminium construction
- Supplied with removable basket and padded seat
- Warranty: 12 months



Burgundy Metallic



Blue Metallic

✓ DVA CONTRACTED
AP12..... BUY
Prescribers... Phys/OT/Ch/Ost/S/LMO
For approval rules refer to pg 7.

Code	Description	Width B/W Arms	Seat Ht.	Handle Ht.	Product Weight	Max. User Wt.	Supplier Code	✓ RAP #:
WAF705700	Seat Walker H/ Brakes 7" Wheels	435 mm	570 mm	840 - 940 mm	7.4 kg	120 kg	KA362/KF95103	AP12
WAF709600	Seat Walker H/ Brakes 6" Wheels	440 mm	557 mm	820 - 940 mm	7.4 kg	120 kg	KA365/KF95105	AP12
WAF705800	Seat Walker - Small Frame 7" Wheels	435 mm	475 mm	740 - 840 mm	7.0 kg	120 kg	KA365S/7KF95104	AP12



Seat Walker Push Down Brakes

- Provides assistance to those who need confidence walking and require rest en route
- Push down breaking system assists those with arthritis or other hand weaknesses
- Folds away for easy storage or transportation
- Height adjustable handles to suit user requirements
- Padded backrest for seating comfort
- Lightweight aluminium construction
- Burgundy or Blue metallic colours available

✓ DVA CONTRACTED
AP12..... BUY
Prescribers... Phys/OT/Ch/Ost/S/LMO
For approval rules refer to pg 7.

- Supplied with removable basket and padded seat (Vinyl bag available as an accessory)
- Warranty: 12 months

Code	Description	Width B/W Arms	Seat Ht.	Handle Ht.	Product Wt.	Max. User Wt.	Supplier Code	✓ RAP #:
WAF705600	S/ Walker P/ Down 7" Wheels	435 mm	570 mm	840 - 940 mm	7.4 kg	120 kg	KA363/KF95106	AP12

Seat Walker Accessories



Walking Stick Holder for Walker

- Attached to A Frame Seat Walkers
- Top mount clamp to securely hold the walking stick in place

Code	Description	RAP #:
WAA686885	Walking Stick Holder for Walkers	AP15



Clip on Walker Bag

- Accessory to suit Seat Walker Hand Brakes and Seat Walker Push Down Brakes
- Warranty: 12 months

Code	Description	RAP #:
WAA686460	Clip on Walker Bag	AP22



Seat Walker/A Frame Walker Basket

- Accessory to suit Seat Walker Hand Brakes and Seat Walker Push Down Brakes
- Warranty: 12 months

Code	Description	RAP #:
WAA687000	Walker Basket	AP22
WAA687001	Walker Basket - Small	AP22

✓ DVA For eligibility & prescriber info please refer to pg 7.



Wheelie Walker

- Provides assistance to those who need confidence walking and require rest en route
- Three wheels make it ideal for use in confined spaces
- Folds away for easy storage or transportation
- Height adjustable handles to suit user requirements
- Handbrakes are lockable for stability while standing
- Strong heavy gauge steel construction
- Supplied with basket and bag

✓ DVA CONTRACTED

AP12..... BUY
Prescribers... Phys/OT/Ch/Ost/S/LMO

AP21..... BUY (P.A Rqd)
Prescribers... Phys/OT/S/Ch/Ost/LMO/RN

AP22..... BUY
Prescribers... Phys/OT/S/Ch/Ost/LMO/RN

For approval rules refer to pg 7.

Code	Description	Width	Handle Ht.	Warranty	Product Wt.	Max. User Wt.	Supplier Code	✓ RAP #:
WAF705500	Wheelie Walker	635 mm	760 - 910 mm	12 months	12.5 kg	100 kg	KA359	AP12
WAA686930	Replacement Bag for Wheelie Walker							AP21
WAA687060	Replacement Basket for Wheelie Walker							AP22



Riva Multiwalker

- Provides assistance to those who need confidence walking and require rest en route
- Heavy duty walker with excellent durability
- Removable tray to access rubber seat
- Folds away for storage or transportation
- 610 mm seat height
- Large wheels for excellent manoeuvrability and stability
- Height adjustable handles to suit user requirement
- Handbrakes are lockable for stability while sitting or standing

✓ DVA CONTRACTED

AP12..... BUY
Prescribers... Phys/OT/Ch/Ost/S/LMO

For approval rules refer to pg 7.

- Supplied with large shopping and storage basket

Code	Description	B/W Arms	Seat Ht.	Handle Ht.	Warranty	Product Wt.	Max. User Wt.	Supplier Code	✓ RAP #:
WAF706100	Riva Walker	570 mm	610 mm	790 - 970 mm	12 months	15 kg	120 kg	KA366/KF95037	AP12



Maxicare Walker

- Provides assistance to those who need confidence walking and require rest en route
- Extra wide seat and reinforced frame for the bariatric user
- Folds away for easy storage or transportation
- Includes plastic tray
- Height adjustable handles to suit user requirements
- Handbrakes are lockable for stability while sitting or standing
- Padded backrest for seating comfort
- Anodised aluminium frame construction
- Supplied with removable basket and padded seat

✓ DVA CONTRACTED

AP12..... BUY
Prescribers... Phys/OT/Ch/Ost/S/LMO

For approval rules refer to pg 7.

Code	Description	B/W Arms	Seat Ht.	Handle Ht.	Warranty	Product Wt.	Max. User Wt.	Supplier Code	✓ RAP #:
WAF699400	Maxicare Walker	570 mm	560 mm	840 - 920 mm	12 months	15.5 kg	225 kg	KA365M	AP12



Heavy Duty Envoy

- The Heavy Duty Envoy is an ideal option for the oversized user
- Anodised aluminium height adjustable frame
- Loop style brakes
- Deluxe padded seat and a curved backrest
- Large 8" castor wheels are great for outdoor terrain

✓ DVA CONTRACTED

AP12..... BUY
Prescribers... Phys/OT/Ch/Ost/S/LMO

For approval rules refer to pg 7.

Code	Description	Between Arms	Seat Ht.	Handle Ht.	Warranty	Product Wt.	Max. User Wt.	✓ RAP #:
WAF705900	Heavy Duty Envoy	550 mm	510 mm	790 - 930 mm	12 months	10 kg	170 kg	AP12



Lets Go Indoor Walker

- Narrow width and easy turn excellent for indoor use
- Easy to use brake can be activated with one hand
- Supplied with removable plastic tray and carry bag
- Warranty: 12 months
- Max. user weight 100 kg



Mobilisor (Paediatric)

- Mobilisor range is a sturdy, folding, height - adjustable walking frame for children
- Includes fixed front castors and rear glides
- Warranty: 12 months
- Max. user weight (WAF704200) 60 kg (WAF708600) 80 kg

DVA For eligibility & prescriber info please refer to pg 7.

Code	Description	Width	Handle Ht.	RAP #:	Code	Description	Width	Handle Ht.	Supplier Code
WAF706150	Lets Go Indoor Walker	540 mm	790 - 900 mm	AP12	WAF704200	Mobilisor Child	410 mm	500 - 700 mm	KA358CF
WAF706156	Tray for Lets Go Indoor Walker			AP21	WAF708600	Mobilisor Junior	495 mm	700 - 1000 mm	KA358JF



Aluminium Non-Folding Walking Frame

- Provides assistance for those who have difficulty walking
- Lightweight aluminium frame ideal for indoor use
- Height adjustable to suit user requirements
- Supplied with four rubber tips



FOR SKI & WHEEL ACCESSORIES
REFER TO PG 303

DVA CONTRACTED
AP12..... BUY
Prescribers... Phys/OT/Ch/Ost/S/LMO
AP21..... BUY (P.A Rqd)
Prescribers... Phys/OT/S/Ch/Ost/LMO/RN
For approval rules refer to pg 7.

Code	Description	Width	Handle Height	Ferrule Tip	Warranty	Product Weight	Max. User Wt.	RAP #:
WAF704900	A/ Walking Frame Small	560 mm	670 - 740 mm	25 mm	12 months	1.9 kg	160 kg	AP12
WAF704800	A/ Walking Frame Medium	560 mm	760 - 840 mm	25 mm	12 months	1.9 kg	160 kg	AP12
WAF704700	A/ Walking Frame Large	560 mm	870 - 940 mm	25 mm	12 months	1.9 kg	160 kg	AP12
WAA686450	Walking Frame Front Castors							AP21



Aluminium Folding Walking Frame

- Provides assistance for those who have difficulty walking
- Folds flat for easy transportation and storage
- Lightweight aluminium frame ideal for indoor use
- Height adjustable to suit user requirements
- Supplied with four rubber tips



FOR SKI & WHEEL ACCESSORIES
REFER TO PG 303

DVA CONTRACTED
AP12..... BUY
Prescribers... Phys/OT/Ch/Ost/S/LMO
For approval rules refer to pg 7.

Code	Description	Width	Handle Height	Ferrule Tip	Warranty	Product Weight	Max. User Weight	RAP #:
WAF706700	A/ Folding Walking Frame S	610 mm	710 - 787 mm	25 mm	12 months	2 kg	127 kg	AP12
WAF706800	A/ Folding Walking Frame M	610 mm	787 - 860 mm	25 mm	12 months	2 kg	127 kg	AP12
WAF706900	A/ Folding Walking Frame L	610 mm	860 - 935 mm	25 mm	12 months	2 kg	127 kg	AP12



Forearm Gutter Walking Frame

- Provides assistance for those who have difficulty walking
- For users who have limited hand or wrist strength, can weight bear through forearms
- Unique folding design for storage or transportation (300 x 640 mm)
- Height adjustable forearm supports to suit user requirements
- Adjustable hand grips to suit user forearm length
- Swivel wheels for manoeuvrability
- Powder coated mild steel construction
- Skis available as an option instead of rear rubber tips

DVA CONTRACTED
AP12..... BUY
Prescribers... Phys/OT/Ch/Ost/S/LMO
For approval rules refer to pg 7.

Code	Description	Front Width	Rear Width	Depth	Height of Forearm Support	Warranty	Product Weight	Max. User Weight	RAP #:
WAF705950	W/ Frame Gutter	400 mm	600 mm	680 mm	860 - 1250 mm	12 months	5 kg (frame only)	100 kg	AP12



Walking Tutor Forearm Gutter Frame

- Provides assistance for those who have difficulty walking
- Tutors the user into an upright gait
- Folding design for storage or transportation
- Height adjustable forearm supports to suit user requirements
- Adjustable hand grips to suit user forearm length
- Four swivel castors for manoeuvrability
- Powder coated mild steel construction
- Skis or glides available as an option as well as padded arm rest
- Warranty: 12 months

DVA CONTRACTED

AP12..... BUY

Prescribers... Phys/OT/Ch/Ost/S/LMO

For approval rules refer to pg 7.

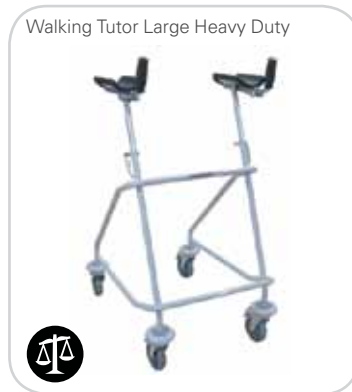
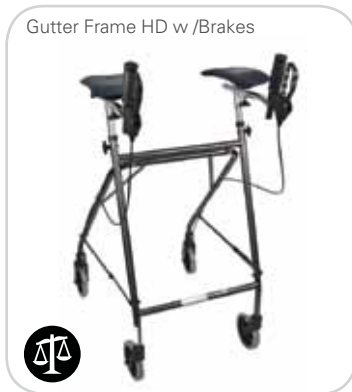
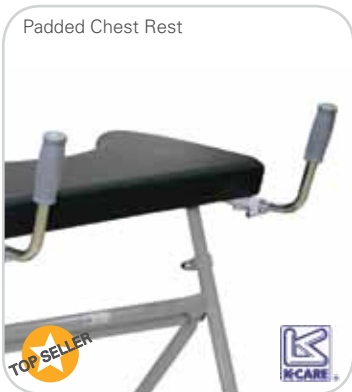

Code	Description	Depth	Height of Forearm Support	Max. User Weight	Supplier Code	RAP #:
WAF704400	Walking Tutor Small	410 mm	600 - 790 mm	60 kg	KA360C	-
WAF704500	Walking Tutor Small w/ Glides	410 mm	600 - 790 mm	60 kg	KA360CG	-
WAF704600	Walking Tutor Small w/ Padded Chest Rest	410 mm	600 - 790 mm	60 kg	KA360CPR	-
WAF709200	Walking Tutor Medium	495 mm	670 - 960 mm	80 kg	KA360J	AP12
WAF709300	Walking Tutor Medium w/ Glides	495 mm	670 - 960 mm	80 kg	KA360JG	AP12
WAF709400	Walking Tutor Medium w/ Padded Chest Rest	495 mm	670 - 960 mm	80 kg	KA360JPR	AP12
WAF708900	Walking Tutor Large	515 mm	850 - 1350 mm	100 kg	KA360A	AP12
WAF709000	Walking Tutor Large w/ Glides	515 mm	850 - 1350 mm	100 kg	KA360AG	AP12
WAF709100	Walking Tutor Large w/ Padded Chest Rest	515 mm	850 - 1350 mm	100 kg	KA360APR	AP12
KA360AHD	Walking Tutor Large Heavy Duty	900 mm	850 - 1350 mm	175 kg	KA360AHD	-
WAF699200	Gutter Frame HD w /Brakes	840 mm	1000 - 1270 mm	180 kg		-

REFER TO PAGE 154 FOR OUR RANGE OF SCOOTERS



Walking Frames & Aids - Mobility



Folding Walking Stick

- Conveniently snaps open in seconds and folds away into a small bag
- Polished hardwood handle and matt black aluminium stick
- Warranty: 12 months

DVA For eligibility & prescriber info please refer to pg 7.

Code	Description	Handle Height	Ferrule Tip	Product Weight	RAP #:
WAS744700	Folding Walking Stick	787 - 890 mm	18 mm	400 g	AP13



T Handle Walking Stick

- Adjustable height to suit user
- Polished hardwood handle and matt black aluminium stick
- Warranty: 12 months

DVA For eligibility & prescriber info please refer to pg 7.

Code	Description	Handle Height	Ferrule Tip	Product Weight	Supplier Code	RAP #:
WAS743600	T Handle W/Stick	715 - 970 mm	18 mm	365 g	KA308	AP13



Swan Neck Walking Stick with Strap

- Adjustable height to suit user
- Aluminium stick with unique foam swan handle for maximum comfort and strap for added security
- Warranty: 12 months

DVA For eligibility & prescriber info please refer to pg 7.

Code	Description	Handle Height	Ferrule Tip	Max. User Weight	RAP #:
WAS743700	Swan Walking Stick with Strap	730 - 985 mm	18 mm	100 kg	AP13
WAS743800	T Handle Swan Walking Stick Adjustable	710 - 965 mm	22 mm	127 kg	AP13
WAS744750	Bariatric Walking Stick	737 - 966 mm	28 mm	226 kg	AP13



Walking Stick Palm Grip

- Unique, biometrically shaped handle designed to evenly spread pressure across the palm of the hand
- Very useful for those with arthritis or poor grip
- Right and left hand available
- Warranty: 12 months

DVA For eligibility & prescriber info please refer to pg 7.

Code	Description	Handle Height	Ferrule Tip	Product Weight	RAP #:
WAS744300	Walking Stick Palm Right Grip	670 - 935 mm	18 mm	400 g	AP13
WAS744400	Walking Stick Palm Left Grip	670 - 935 mm	18 mm	400 g	AP13



Walking Stick Quad Base

- Adjustable height to suit user
- Four point base for extra stability
- Soft foam hand grip
- Warranty: 12 months

DVA For eligibility & prescriber info please refer to pg 7.

Code	Description	Handle Height	Base M'tment	Ferrule Tip	Product Wt.	RAP #:
WAS744600	Walking Stick Quad Small Base	740 - 970 mm	200 x 150 mm	12.5 mm	1 kg	AP06
WAS744500	Walking Stick Quad Large Base	740 - 970 mm	300 x 200 mm	15.6 mm	1.2 kg	AP06



Walking Stick Pyramid

- Adjustable height to suit user
- Pyramid base for extra stability
- Soft foam hand grip
- Warranty: 12 months

DVA For eligibility & prescriber info please refer to pg 7.

Code	Description	Handle Height	Base Measurement	RAP #:
WAS743900	Walking Stick Pyramid	790 - 920 mm	220 x 200 mm	AP06

SEE GENERAL ACCESSORIES ON PAGE 303
FOR OUR RANGE OF FERRULES (RUBBER TIPS)
AND FOR ALL TYPES OF CRUTCHES, STICKS, FRAMES





Walking Stick with Folding Seat

- Lightweight aluminium walking stick that has a built in seat
- Ideal for resting when out and about
- Compact design allows the seat to be folded up when not in use

Code	Description	Handle Height	Seat Height	Warranty
WAS744000	Walking Stick with Folding Seat	866 mm	570 mm	12 months



Walking Stick Crook Handle

- Adjustable height to suit user
- Comfortable crook handle covered in foam for comfort
- Warranty: 12 months



Walking Stick Wooden with Crook Handle

- Polished wooden walking stick with a crook handle supplied at a fixed height of 915mm
- Can be cut down to suit individual users height
- Warranty: 12 months

DVA For eligibility & prescriber info please refer to pg 7.

Code	Description	Handle Height	Ferrule Tip	Product Weight	RAP #:	Code	Description	Handle Height	Ferrule Tip	Product Weight	Supplier Code
WAS744200	Walking Stick Wooden with Crook Handle	762 - 991 mm	18 mm	400 g	AP13	WAS745500	Walking Stick Wooden with Crook Handle	915 mm	18 mm	350g	KA300



Walking Stick Holder

- Clever clip allows the walking stick to rest on a table or desk instead of the floor
- Stick inserted into a spring loaded opening and rests in the upright position



Walking Stick Wrist Strap

- Easily attaches to stem of Walking Stick with elastic strap

DVA For eligibility & prescriber info please refer to pg 7.

DVA For eligibility & prescriber info please refer to pg 7.

Code	Description	Warranty	RAP #:	Code	Description	Warranty	RAP #:
WAA686880	Walking Stick Holder	12 months	AP15	WAA686620	Walking Stick Wrist Strap	12 months	AP15

REFER TO PAGE 210 FOR OUR RANGE OF RAMPS





Forearm Crutches

- Lightweight and durable forearm crutches to suit a large range of users
- Cuff provides a secure fitting to the forearm
- Adjustable height between cuff and handle & handle and ground
- Warranty: 12 months

✓ DVA CONTRACTED
 AP03..... BUY
 Prescribers... Phys/OT/Ch/Ost/LMO/S
 For approval rules refer to pg 7.

Code	Description	User Height	Crutch Height	Ferrule	Product Weight	Max. User Weight	✓ RAP #:
WAC692000	Forearm Crutches Youth Small	1230 - 1640 mm	530 - 785 mm	22 mm	600 g (each)	127 kg	AP03
WAC691400	Forearm Crutches Adult Medium	1480 - 1860 mm	635 - 910 mm	22 mm	600 g (each)	127 kg	AP03
WAC691800	Forearm Crutches Adult Tall Large	1740 - 2040 mm	820 - 1075 mm	22 mm	600 g (each)	127 kg	AP03



Forearm Crutches Ergonomic

- Lightweight and durable forearm crutches to suit a large range of users
- Ergonomic shaped handle distributes the pressure more evenly across the hand
- Cuff provides a secure fitting to the forearm
- Adjustable height between cuff and handle & handle and ground
- Warranty: 12 months

✓ DVA CONTRACTED
 AP03..... BUY
 Prescribers... Phys/OT/Ch/Ost/LMO/S
 For approval rules refer to pg 7.

Code	Description	User Height	Crutch Height	Ferrule	Product Weight	Max. User Weight	✓ RAP #:
WAC691500	Forearm Crutches Ergonomic Medium	1585 - 1800 mm	580 - 835 mm	22 mm	715 g (each)	127 kg	AP03
WAC691900	Forearm Crutches Ergonomic Large	1706 - 2010 mm	680 - 935 mm	22 mm	715 g (each)	127 kg	AP03



Forearm Crutches Custom

- Reinforced aluminium construction designed for users with long term needs
- Absence of adjustment holes makes the crutch "silent" in use
- Supplied in one standard length and may be cut to the required length
- Please specify handle to floor height at time of order
- Warranty: 12 months

✓ DVA CONTRACTED
 AP03..... BUY
 Prescribers... Phys/OT/Ch/Ost/LMO/S
 For approval rules refer to pg 7.

Code	Description	Cuff to Handle	Handle to Floor	Ferrule Tip	Product Weight	Max. User Weight	✓ RAP #:
WAC688400	Forearm Crutches Custom	229 mm	1040 mm	22 mm	800 g (each)	190 kg	AP03



Kids Forearm Crutches

- Just for kids
- These light weight yellow Forearm Crutches are height adjustable

Code	Description	Handle Height	Ferrule	Warranty	Max. User Weight
WAC691700	Crutches Forearm Child 4 - 7 years	440 - 670 mm	18 mm	12 months	100 kg
WAC691600	Crutches Forearm Child 6 - 10 years	380 - 530 mm	18 mm	12 months	100 kg

Walking Frames & Aids - Mobility





Underarm Crutches

- Patented clip - lock adjustable handle and push button foot pieces for fast, precise measuring and fitting
- Lightweight aluminium frame
- High density rubber cushions and handgrips providing long wear and greater comfort
- Warranty: 12 months

✓ DVA CONTRACTED
 AP03..... BUY
 Prescribers... Phys/OT/Ch/Ost/LMO/S
 For approval rules refer to pg 7.

Code	Description	User Height	Crutch Height	Ferrule Tip	Product Weight	Max. User Wt.	✓ RAP #:
WAC692300	Underarm Crutches Child	1220 - 1370 mm	800 - 950 mm	22 mm	1.10 kg (each)	91 kg	-
WAC692500	Underarm Crutches Youth	1370 - 1575 mm	940 - 1145 mm	22 mm	1.25 kg (each)	136 kg	AP03
WAC692200	Underarm Crutches Adult	1550 - 1755 mm	1120 - 1320 mm	22 mm	1.25 kg (each)	136 kg	AP03
WAC692400	Underarm Crutches Adult Tall	1780 - 1980 mm	1320 - 1520 mm	22 mm	1.25 kg (each)	136 kg	AP03

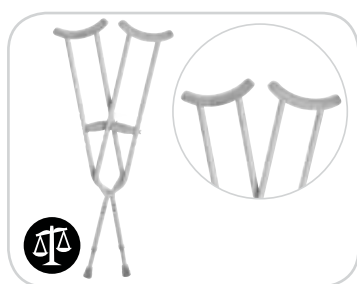

Underarm Crutches Bariatric

- Designed with strength to support the bariatric user
- Steel construction provides durability and support up to 249 kg
- Warranty: 12 months

✓ DVA CONTRACTED
 AP03..... BUY
 Prescribers... Phys/OT/Ch/Ost/LMO/S
 For approval rules refer to pg 7.

Code	Description	User Height	Crutch Height	Ferrule Tip	Product Weight	Max. User Weight	✓ RAP #:
WAC688300	Underarm Crutches Bariatric Adult	1550 - 1750 mm	1120 - 1320 mm	22 mm	4.7 kg	249 kg	AP03
WAC688200	Underarm Crutches Bariatric Adult Tall	1780 - 1980 mm	1320 - 1520 mm	22 mm	4.7 kg	249 kg	AP03



Crutch Cushion

- Replacement Axilla Cushion for Underarm Crutches

✓ DVA For eligibility & prescriber info please refer to pg 7.

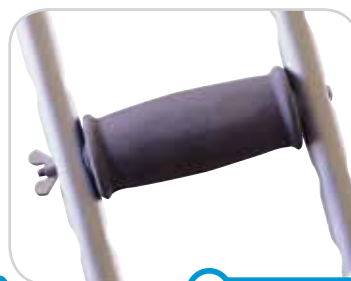

Crutch Hand Grip

- Replacement Cushion handle to suit Underarm Crutches

✓ DVA For eligibility & prescriber info please refer to pg 7.

Code	Description	✓ RAP #:	Code	Description	✓ RAP #:
WAA686240	Crutch Grey Axilla Cushion	AP21	WAA686220	Crutch Grey Hand Grip Padding	AP21
WAA686250	Crutch Grey Axilla Bariatric Cushion	AP21	WAA686230	Crutch Grey Hand Grip Bariatric	AP21



Gutter Crutches

- Ideal for those with limited hand or wrist strength
- Lightweight tubular aluminium stem and padded vinyl covered gutter for maximum comfort
- Designed for users with arthritis or an impaired grip
- Forearm trough distributes a user's weight over a large support area
- Adjustable telescopic handle rotates through 360 degrees and locks to suit individual forearm length

✓ DVA CONTRACTED
 AP03..... BUY
 Prescribers... Phys/OT/Ch/Ost/LMO/S
 For approval rules refer to pg 7.

Code	Description	Gutter Height	Ferrule Tip	Warranty	Product Weight	Max. User Weight	✓ RAP #:
WAC694200	Gutter Crutches	980 - 1235 mm	25 mm	12 months	950g (each)	127 kg	AP03



Ferrules/Rubber Tips

- High quality rubber ferrule tips suitable for use with walking frames, crutches, walking sticks and quad sticks

✓ DVA CONTRACTED
 AP21..... BUY (P.A Rqd)
 Prescribers... Phys/OT/S/Ch/Ost/LMO/RN
 For approval rules refer to pg 7.

Code	Description	✓ RAP #
WAA686280	Rubber Ferrule 12.5 mm Black (pkt 4)	AP21
WAA686290	Rubber Ferrule 15.6 mm Black (pkt 4)	AP21
WAA686300	Rubber Ferrule 16 mm Grey	AP21
WAA686310	Rubber Ferrule 18 mm Grey	AP21
WAA686332	Rubber Ferrule 18 mm Black	AP21
WAA686320	Rubber Ferrule 22 mm Grey	AP21
WAA686330	Rubber Ferrule 25 mm Grey	AP21



Glides

- Alternative to the rubber stoppers commonly used on the rear legs of aluminium folding walking frames
- Helps the frame to slide easily indoors
- Sold as each

✓ DVA CONTRACTED
 AP21..... BUY (P.A Rqd)
 Prescribers... Phys/OT/S/Ch/Ost/LMO/RN
 For approval rules refer to pg 7.

Code	Description	✓ RAP #
WAA686690	Glide White 19 mm, Black Dot	AP21
WAA686700	Glide White 22.2 mm, Green Dot	AP21
WAA686710	Glide White 25 mm, Red Dot	AP21
WAA686720	Glide White 28.6 mm, Blue Dot	AP21
WAA686730	Glide White 25.4 mm, Yellow Dot	AP21



Skis

- Alternative to the rubber stoppers commonly used on the rear legs of rollator-style walking frames
- Helps the frame to slide easily indoors, easily attached

✓ DVA CONTRACTED
 AP21..... BUY (P.A Rqd)
 Prescribers... Phys/OT/S/Ch/Ost/LMO/RN
 For approval rules refer to pg 7.

Code	Description	✓ RAP #
WAA686530	Two Piece Skis 22.2 mm (pair)	AP21
WAA686540	Two Piece Ski 28.6 mm (sold as each)	AP21
WAA686550	Two Piece Ski 25.4 mm (sold as each)	AP21



Wheels

- These light weight front castor wheels are designed to suit the Aluminium Walking Frames and Aluminium Walking Frame Folding

✓ DVA CONTRACTED
 AP21..... BUY (P.A Rqd)
 Prescribers... Phys/OT/S/Ch/Ost/LMO/RN
 For approval rules refer to pg 7.

Code	Description	✓ RAP #
WAA686450	Walking Frame Wheels (pair)	AP21

Walking Frames & Aids - Mobility

Ward & Clinic



- P 305** Medicine/Flexi Carts
- P 307** Medicine/Flexi Carts Options
- P 310** GP/Physio Room Equipment
- P 312** Kitchen Trolleys
- P 313** Instrument Trolleys
- P 315** Ward Equipment
- P 318** Patient Response Trolleys
- P 319** Weigh Chairs & Scales



Webster Cart 3 Drawer (48)

- Suitable for the Webster Medication System for 48 residents
- Features ABS plastic removable recessed top
- Universal locking drawers with magnetic drawer catches
- Wide wheel base with four 125mm swivel castors for easy transportation
- Optional waste bin and folding shelf available
- Mobile medication cart with 3 drawers
- Warranty: 36 months

Code	Description	Width	Depth	Height	Supplier Code
WAT808900	Flexi Cart Webster 3 Drawer Arctic Fox	635 mm	485 mm	1045 mm	KH220WA
WAT809000	Flexi Cart Webster 3 Drawer Admiralty Grey	635 mm	485 mm	1045 mm	KH220WAG
WAT809100	Flexi Cart Webster 3 Drawer Beige	635 mm	485 mm	1045 mm	KH220WB
WAT809200	Flexi Cart Webster 3 Drawer Blue Weave	635 mm	485 mm	1045 mm	KH220WBW
WAT809300	Flexi Cart Webster 3 Drawers Navy	635 mm	485 mm	1045 mm	KH220WN
WAT809400	Flexi Cart Webster 3 Drawers Red	635 mm	485 mm	1045 mm	KH220WR
WAT809500	Flexi Cart Webster 3 Drawers White	635 mm	485 mm	1045 mm	KH220WW



Webster Cart 2 Drawer (24)

- Suitable for the Webster Medication System for 24 residents
- Features ABS plastic removable recessed top
- Universal locking drawers with magnetic drawer catches
- Four 125mm swivel castors for easy transportation
- Optional waste bin and folding shelf available (Pictured)
- Mobile medication cart with 2 drawers
- Warranty: 36 months

Code	Description	Width	Depth	Height	Supplier Code
WAT810400	Flexi Cart Webster 2 Drawer Arctic Fox	635 mm	485 mm	1015 mm	KH222WA
WAT810500	Flexi Cart Webster 2 Drawer Admiralty Grey	635 mm	485 mm	1015 mm	KH222WAG
WAT810600	Flexi Cart Webster 2 Drawer Beige	635 mm	485 mm	1015 mm	KH222WB
WAT810700	Flexi Cart Webster 2 Drawer Blue Weave	635 mm	485 mm	1015 mm	KH222WBW
WAT810800	Flexi Cart Webster 2 Drawers Navy	635 mm	485 mm	1015 mm	KH222WN
WAT810900	Flexi Cart Webster 2 Drawers Red	635 mm	485 mm	1015 mm	KH222WR
WAT811000	Flexi Cart Webster 2 Drawers White	635 mm	485 mm	1015 mm	KH222WW



Flexi Cart: Medicine Cart 5 Drawers (48)

- Mobile medication cart with a 48 patient capacity
- Individual compartments fitted with identification labels
- Features universal locking drawers plus a deep bottom drawer for large items
- ABS plastic removable recessed top
- Optional folding shelf also available
- Warranty: 36 months

Code	Description	Width	Depth	Height	Supplier Code
WAT808200	Flexi Cart 5 Drawers Arctic Fox	635 mm	485 mm	1000 mm	KH220A
WAT808300	Flexi Cart 5 Drawers Admiralty Grey	635 mm	485 mm	1000 mm	KH220AG
WAT808400	Flexi Cart 5 Drawers Beige	635 mm	485 mm	1000 mm	KH220B
WAT808500	Flexi Cart 5 Drawers Blue Weave	635 mm	485 mm	1000 mm	KH220BW
WAT808600	Flexi Cart 5 Drawers Navy	635 mm	485 mm	1000 mm	KH220N
WAT808700	Flexi Cart 5 Drawers Red	635 mm	485 mm	1000 mm	KH220R
WAT808800	Flexi Cart 5 Drawers White	635 mm	485 mm	1000 mm	KH220W



Flexi Cart: Medicine Cart 3 Drawers (24)

- Mobile medication cart with a 24 patient capacity
- Capacity can be increased with the use of the larger bottom drawer
- Universal locking drawers with magnetic drawer catches
- Lightweight and durable construction
- Four 125mm swivel castors as well as push handles for easy transportation
- Warranty: 36 months

Code	Description	Width	Depth	Height	Supplier Code
WAT809600	Flexi Cart 3 Drawers Arctic Fox	635 mm	485 mm	975 mm	KH222A
WAT809700	Flexi Cart 3 Drawers Admiralty Grey	635 mm	485 mm	975 mm	KH222AG
WAT809800	Flexi Cart 3 Drawers Beige	635 mm	485 mm	975 mm	KH222B
WAT809900	Flexi Cart 3 Drawers Blue Weave	635 mm	485 mm	975 mm	KH222BW
WAT810100	Flexi Cart 3 Drawers Navy	635 mm	485 mm	975 mm	KH222N
WAT810200	Flexi Cart 3 Drawers Red	635 mm	485 mm	975 mm	KH222R
WAT810300	Flexi Cart 3 Drawers White	635 mm	485 mm	975 mm	KH222W



Flexi Cart: Suture 3 Drawers w/Shelf

- Two fully extendable drawers suitable for storage of suture boxes (24 per drawer),
- One fully extendable deep drawer for general storage
- Utility shelf
- Suture display cabinet with shelf (holds 30 suture boxes)
- Push handle
- Clear acrylic top for viewing of suture boxes stored in top drawer
- Warranty: 36 months

Code	Description	Width	Depth	Height	Supplier Code
WAT813700	Flexi Cart Suture 3 Drawers w/ Shelf Arctic Fox	635 mm	485 mm	1300 mm	KH229A
WAT813800	Flexi Cart Suture 3 Drawers w/ Shelf Admiralty Grey	635 mm	485 mm	1300 mm	KH229AG
WAT813900	Flexi Cart Suture 3 Drawers w/ Shelf Beige	635 mm	485 mm	1300 mm	KH229B
WAT814000	Flexi Cart Suture 3 Drawers w/ Shelf Blue Weave	635 mm	485 mm	1300 mm	KH229BW
WAT814100	Flexi Cart Suture 3 Drawers w/ Shelf Navy	635 mm	485 mm	1300 mm	KH229N
WAT814200	Flexi Cart Suture 3 Drawers w/ Shelf Red	635 mm	485 mm	1300 mm	KH229R
WAT814300	Flexi Cart Suture 3 Drawers w/ Shelf White	635 mm	485 mm	1300 mm	KH229W



Flexi Cart: Anaesthetic 5 Drawers

- Anaesthetic Cart has a 48 patient capacity
- Individual compartments fitted with identification labels
- Features universal locking drawers plus a deep bottom drawer for large items
- Stainless steel top and guard rail
- Optional folding shelf also available
- Warranty: 36 months

Code	Description	Width	Depth	Height	Supplier Code
WAT811100	Flexi Cart Anaesthetic 5 Drawers Arctic Fox	635 mm	485 mm	1000 mm	KH224A
WAT811200	Flexi Cart Anaesthetic 5 Drawers Admiralty Grey	635 mm	485 mm	1000 mm	KH224AG
WAT811300	Flexi Cart Anaesthetic 5 Drawers Beige	635 mm	485 mm	1000 mm	KH224B
WAT811400	Flexi Cart Anaesthetic 5 Drawers Blue Weave	635 mm	485 mm	1000 mm	KH224BW
WAT811500	Flexi Cart Anaesthetic 5 Drawers Navy	635 mm	485 mm	1000 mm	KH224N
WAT811600	Flexi Cart Anaesthetic 5 Drawers Red	635 mm	485 mm	1000 mm	KH224R
WAT811700	Flexi Cart Anaesthetic 5 Drawers White	635 mm	485 mm	1000 mm	KH224W



Flexi Cart: Theatre 5 Drawers

- 9 plastic- plastic tilt containers- 65w x 77h x 62d
- 6 plastic- plastic tilt containers- 95w x 113h x 91d
- 5 plastic-plastic tilt container - 120w x 164h x 133d
- Magnetic drawer catches - prevent unlocked drawers from opening while in motion
- Push handle
- Warranty: 36 months
- Stainless steel top & guard rail

Code	Description	Width	Depth	Height	Supplier Code
WAT812300	Flexi Cart Theatre 5 Drawers Arctic Fox	635 mm	485 mm	960 mm	KH227A
WAT812400	Flexi Cart Theatre 5 Drawers Admiralty Grey	635 mm	485 mm	960 mm	KH227AG
WAT812500	Flexi Cart Theatre 5 Drawers Beige	635 mm	485 mm	960 mm	KH227B
WAT812600	Flexi Cart Theatre 5 Drawers Blue Weave	635 mm	485 mm	960 mm	KH227BW
WAT812700	Flexi Cart Theatre 5 Drawers Navy	635 mm	485 mm	960 mm	KH227N
WAT812800	Flexi Cart Theatre 5 Drawers Red	635 mm	485 mm	960 mm	KH227R
WAT812900	Flexi Cart Theatre 5 Drawers White	635 mm	485 mm	960 mm	KH227W



Flexi Cart: Theatre Equipment 5 Drawers

- Accessory module complete with sharps collector recess, waste bin and three accessory shelves
- Adjustable equipment shelves - Dimensions (mm): 575w x 325d
- A.B.S. plastic removable recessed top
- Warranty: 36 months
- Magnetic drawer catches - prevent unlocked drawers from opening while in motion

Code	Description	Width	Depth	Height	Supplier Code
WAT813000	Flexi Cart Theatre Equipment 5 Drawers Arctic Fox	865 mm	485 mm	1570 mm	KH228A
WAT813100	Flexi Cart Theatre Equipment 5 Drawers Admiralty Grey	865 mm	485 mm	1570 mm	KH228AG
WAT813200	Flexi Cart Theatre Equipment 5 Drawers Beige	865 mm	485 mm	1570 mm	KH228B
WAT813300	Flexi Cart Theatre Equipment 5 Drawers Blue Weave	865 mm	485 mm	1570 mm	KH228BW
WAT813400	Flexi Cart Theatre Equipment 5 Drawers Navy	865 mm	485 mm	1570 mm	KH228N
WAT813500	Flexi Cart Theatre Equipment 5 Drawers Red	865 mm	485 mm	1570 mm	KH228R
WAT813600	Flexi Cart Theatre Equipment 5 Drawers White	865 mm	485 mm	1570 mm	KH228W



Flexi Cart Emergency

- Cart for emergency wards and facilities
- Oxygen bottle carrier & adjustable IV pole
- Four 125mm swivel castors



Folding Shelf with Flat Top

- Handy shelf for storage



Accessory Module

- Accessory module complete with sharps collector recess, waste bin and 3 accessory shelves

Code	Description	Code	Description	Code	Description
WAT812200	Emergency Cart	WAT773600	Folding Shelf with Flat Top	WAT814400	Accessory Module



Stainless Steel Top

- A stainless steel top (shown with KH22R fitted)



Plastic coated Supply Basket

- Handy storage basket



Cardiac Board

- Folding shelf with flat top

Code	Description	Code	Description	Code	Description
WAT818400	Stainless Steel Top	WAT814500	Plastic coated Supply Basket	WAT773600	Cardiac Board



Container Dispensing System

- Enables easy drug distribution, with 10 plastic bins
- Easily identified labelling system



Chart Holder

- Suits standard A4 folder



Flow Chart Holder

- Chart Holder suits standard clip boards

Code	Description	Code	Description	Code	Description
WAT814800	Container Dispensing System	WAT814900	Chart Holder - Standard A4	WAT816300	Flow Chart Holder



Drawer Labels

- Identification drawer labels



Draw Dividers

- Clear polycarbonate, adjustable with labels fitted



Flexi Cart Waste Bin

- A multi use waste bin

Code	Description	Code	Description	Code	Description
WAT815600	Drawer Labels Economy	WAT815400	Draw Dividers Clear Polycarbonate	WAT818500	Flexicart Waste Bin
		WAT815500	Draw Divider Minicards	WAT818600	Waste Bin Beige
		WAT815100	Draw Dividers & Tabs Set (2 sets)		
		WAT815200	Drawer Dividers fitted w/ ID Labels		



Drive Unit

- Retro fit to any flexi cart
- Slow/fast control knob
- Throttle lever for forward/reverse



Sharps Holder Small

- For safe disposal of sharps



Extended Base

- Extended base with full wrap-around bumper

Code	Description	Code	Description	Code	Description
WAT815700	Drive Unit	WAT818300	Sharps Holder Small	WAT815800	Extended Base

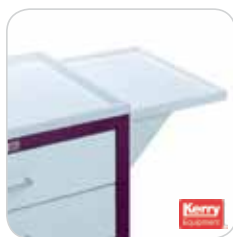

Shelf Catheter

- Folding shelf used to store catheters



Equipment Shelf

- Set of three shelves for storage

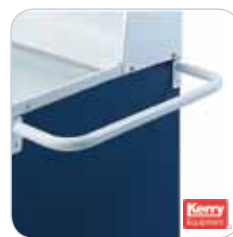

Extended Push Handle

- Aids cart maneuverability

Code	Description	Code	Description	Code	Description
WAT815900	Folding Shelf Catheter	WAT816000	Equipment Shelf Double	WAT816200	Extended Push Handle
		WAT816100	Equipment Shelf Single		



Flexible Light

- Handy light for night use



Folding Shelf with Recessed Top

- Handy shelf for storage



Folding Shelf Heavy Duty with Flat Top

- Heavy loading capacity with one handed opening
- Can replace existing shelf

Code	Description	Code	Description	Code	Description
WAT816400	Flexible Light	WAT816600	Folding Shelf with Recessed Top	WAT816650	Folding Shelf Heavy Duty with Flat Top
WAT816500	Flexible Light Rechargeable				



Folding Shelf to Store Catheters

- Folding shelf used to store catheters



Lockable Compartment

- Separate lockable compartment for controlled drugs



Lockrail

- Lock rail to suit seal or padlock

Code	Description	Code	Description	Code	Description
WAT816700	Folding Shelf to Store Catheters	WAT817000	Lockable Compartment	WAT817500	Lockrail
				WAT817550	Lockrail For Seal



Oxy Bottle Carrier

- Oxygen bottle carrier 'C' size



Stainless Steel Top with Push Handle

- Stainless steel top with push handle / guard rail



ABS Plastic Top

- Recessed (30mm) A.B.S. Plastic top (No pill cup holders)

Code	Description	Code	Description	Code	Description
WAT817600	Oxy Bottle Carrier	WAT817800	Stainless Steel Top with Push Handle	WAT817900	ABS Plastic Top



ABS Plastic Top with Pill and Cup Holder

- Recessed (30mm) A.B.S. Plastic top (With pill cup holders)

Code	Description
WAT818000	ABS Plastic Top with Pill and Cup Holder



Grey Rubber Swivel Castor

- Available in 125 or 150mm sizes



Rubber Total Lock Castor

- Available in 125 or 150mm sizes



Grey Rubber Directional Lock Castor

- Available in 125 or 150mm sizes

Code	Description	Code	Description	Code	Description
MWT469695	Grey Rubber Swivel Castor 125	MWT469640	Grey Rubber Total Lock Castor 125	MWT469625	Grey Rubber Directional Lock Castor 125
MWT469664	Grey Rubber Swivel Castor 150	MWT469665	Grey Rubber Total Lock Castor 150	MWT469692	Grey Rubber Directional Lock Castor 150

Other Accessories

Code	Description
WAT814600	Catheter Holder
WAT816800	Glove Dispenser
WAT816900	IV Pole Attachment & Pole
WAT817100	Large Container Blue
WAT817200	Large Container Grey
WAT817300	Large Container Yellow
WAT818100	Small Container Yellow
WAT817400	Large Draw
WAT817700	Pen Holder
WAT818200	Folding Shelf Flat



Examination Couch

- Complete multi - functional examination couch
- Features adjustable backrest to 85 degrees
- Seamless vinyl upholstered top
- Can be flat packed for easy transportation and storage

Code	Description	Length	Width	Height	Weight Capacity	Supplier Code
WAT820200	Examination Couch Beige	1800 mm	600 mm	840 mm	130 kg	KH320MB
WAT820500	Examination Couch Grey	1800 mm	600 mm	840 mm	130 kg	KH320G
WAT820600	Examination Couch Lithotomy Beige	1800 mm	600 mm	850 mm	130 kg	KH322B
WAT820700	Examination Couch Lithotomy Grey	1800 mm	600 mm	850 mm	130 kg	KH322G



Examination Couch Double Backrest

- Adjustable backrest. Seamless vinyl upholstered top. Flat packable for storage or transport
- Shown with optional Step and Roll Holder (refer to accessories below)

Code	Description	Depth	Width	Height	Supplier Code
WAT820300	Examination Couch Double Backrest Beige	1800 mm	600 mm	600 mm	KH320DBB
WAT820400	Examination Couch Double Backrest Grey	1800 mm	600 mm	600 mm	KH320DBG

Examination Couch Accessories

Code	Description	Supplier Code
WAT821300	Exam Couch Drop Side Rail	KH32DR
WAT822000	Exam Couch Pole Beige	KH32PB
WAT822100	Exam Couch Pole Grey	KH32PG
WAT822200	Exam Couch Roll Holder Beige	KH32RHB
WAT822300	Exam Couch Roll Holder	KH32RHG
WAT822400	Exam Couch Step & Pole Beige	KH32SB
WAT822500	Exam Couch Step	KH32SG
WAT821900	Physio Stirrups with Strap	KH32LS
WAT822700	Post Op Step Single Chrome	KH32SPC

Code	Description	Supplier Code
WAT822800	Post Op Step Single Black Large	KH32SPL
WAT822900	Post Op Step Single Grey Large	KH32SPLG
WAT821000	Exam Couch Cabinet Beige	KH32CB
WAT821100	Exam Couch Cabinet Grey	KH32CG
WAT821400	Exam Couch Lithotomy Footplate Db Beige	KH32FDB
WAT821500	Exam Couch Lithotomy Footplate Db Grey	KH32FDG
WAT821700	Exam Couch Lithotomy Footplate Sgl Beige	KH32FSB
WAT821800	Exam Couch Lithotomy Footplate Sgl Grey	KH32FSG



Ultrasound Couch Grey

- Versatile in patient positioning
- Smooth quiet electric operation (all operations electric)
- Wide wheelbase for stability
- Lightweight and easy to maneuver
- Large work surface

Code	Description	Length	Width	Height	Supplier Code
WAT820800	Ultrasound Couch Grey	2200 mm	650 mm	550 - 1000 mm	KH329
WAT820900	Drop Side Rail				KH329DR
GSP	Battery Backup				KH329B
GSP	Face Hole & Plug				KH329FH



Electric Hi/Low Examination Couch 2 Section

- Examination couch features electric high/low and friction lock backrest
- Breathing hole fitted with plug
- Adjustable height and feet for uneven floors
- High density foam and vinyl cover available in beige or grey
- Warranty: 36 months

Code	Description	Length	Width	High/Low	Max. User Weight	Supplier Code
FPP306000	Examination Couch 2 Section Beige	1950 mm	700 mm	470 - 870 mm	130 kg	KH324B
FPP306050	Examination Couch 2 Section Grey	1950 mm	700 mm	470 - 870 mm	130 kg	KH324G
FPP306100	Examination Couch 3 Section Beige	1950 mm	650 mm	470 - 870 mm	130 kg	KH335B
FPP306200	Examination Couch 3 Section Grey	1950 mm	650 mm	470 - 870 mm	130 kg	KH335G
GSP	2 Section Top					KH324
GSP	5 Section Top					KH326
GSP	Rectangular Head section					KH32RHS



Electric Hi/Low Bobath Plinth

- Plinth used for the treatment of neurological conditions, head injury and stroke patients
- Features electric high/low operation with pneumatic foot switch
- Suitable for turning, rolling and balance training
- Breathing hole fitted with plug
- Heavy duty total lock castors
- High density foam and vinyl covered top
- Warranty: 36 months

Code	Description	Length	Width	High/Low	Max. User Weight	Supplier Code
FPP306800	Bobath Plinth Beige	2000 mm	1190 mm	525 - 900 mm	130 kg	KH334B
FPP306850	Bobath Plinth Grey	2000 mm	1190 mm	525 - 900 mm	130 kg	KH334G
GSP	1 Section Top					KH333
GSP	5 Section Top					KH335
GSP	Additional Face Hole					KH35FH



Electric Hi/Low & Tilt Table

- Tilting table ideal for a rehabilitation setting where weight bearing of the client is required
- Features electric high/low and tilt operation
- Pneumatic hand switch control
- Adjustable negative and positive footrest
- High density foam and vinyl covered top

Code	Description	Length	Width	High/Low	Max. User Weight	Supplier Code
FPP306900	Tilt Table Beige	1900 mm	700 mm	500 - 900 mm	130 kg	KH336B
FPP307000	Tilt Table Grey	1900 mm	700 mm	500 - 900 mm	130 kg	KH336G
FPP307200	Chest Strap					KH36C
FPP307300	Leg Strap					KH33L
FPP307400	Waist Strap					KH33W
FPP307500	Work Table					KH336WT



Food Tray Dispenser

- Food Tray Dispenser is ideal for hospital or nursing home environment
- Lightweight, stainless steel construction
- Two fixed and two swivel 150 mm castors for easy transport
- Optional drive unit available
- Generally made to specification due to variable tray sizes
- Warranty: 12 months

Code	Description	Width	Depth	Height	Supplier Code
WAT823600	Food Tray Dispenser Trolley 16	1000 mm	500 mm	1390 mm	KH430
WAT824000	Food Tray Dispenser Trolley 24	1460 mm	500 mm	1390 mm	KH431
WAT823800	Food Tray Dispenser Trolley Drive Unit				KH430DU
WAT823900	Food Tray Dispenser Trolley Tarp Cover 16 Tray				KH430TC
WAT824200	Food Tray Dispenser Trolley Tarp Cover 24 Tray				KH431TC
WAT824700	Food Tray Plastic				KH43T



Tray Clearing Trolley

- Tray Clearing Trolley is ideal for hospital or nursing home environment
- Stainless steel construction featuring two or three shelves design
- Four 150 mm swivel castors
- Warranty: 12 months

Code	Description	Width	Depth	Height	Supplier Code
WAT824300	Tray Clearing Trolley 2 Shelf with Receptacles	1100 mm	500 mm	1000 mm	KH437
WAT824400	Tray Clearing Trolley 2 Shelf without Receptacles	1100 mm	500 mm	1000 mm	KH435
WAT824500	Tray Clearing Trolley 3 Shelf with Receptacles	810 mm	500 mm	965 mm	KH436
WAT824600	Tray Clearing Trolley 3 Shelf without Receptacles	810 mm	500 mm	965 mm	KH438

REFER TO LAUNDRY & CLEANING
PG 131 FOR OUR FULL RANGE OF
LINEN TROLLEYS AND COMMERCIAL
CLEANING EQUIPMENT





Economy Instrument Trolley

- Instrument Trolley with push handles on both sides
- Epoxy Coated Frame
- Guard rails on three sides
- 75 mm twin wheels
- Warranty: 36 months

Code	Description	Width	Depth	Height	Supplier Code
WAT805300	Economy 500 2 S/S Shelves Epoxy PC Frame	500 mm	500 mm	1015 mm	KH140
WAT806200	Economy 600 2 S/S Shelves Epoxy PC Frame	600 mm	500 mm	1015 mm	KH142
WAT806800	Economy 800 2 S/S Shelves Epoxy PC Frame	800 mm	500 mm	1015 mm	KH150



Economy Instrument Trolley with Drawer

- Instrument Trolley with push handles on both sides plus one stainless steel drawer
- Epoxy Coated Frame
- Guard rails on three sides
- 75 mm twin wheels
- Warranty: 36 months

Code	Description	Width	Depth	Height	Supplier Code
WAT805400	Economy 500 2 S/S Shelves & 1 Drawer Epoxy PC Frame	500 mm	500 mm	1015 mm	KH140D
WAT806300	Economy 600 2 S/S Shelves & 1 Drawer Epoxy PC Frame	600 mm	500 mm	1015 mm	KH142D
WAT806900	Economy 800 2 S/S Shelves & 1 Drawer Epoxy PC Frame	800 mm	500 mm	1015 mm	KH150D



Economy Instrument Trolley with 2 Drawers

- Instrument Trolley with push handles on both sides plus two stainless steel drawers
- Epoxy Coated Frame
- Guard rails on three sides
- Stainless steel shelves
- 75 mm twin wheels
- Warranty: 36 months

Code	Description	Width	Depth	Height	Supplier Code
WAT805500	Economy 500 2 S/S Shelves & 2 Drawers Epoxy PC Frame	500 mm	500 mm	1015 mm	KH140DD
WAT773300	Economy 600 2 S/S Shelves & 2 Drawers Epoxy PC Frame	600 mm	500 mm	1015 mm	KH142DD
WAT807100	Economy 800 2 S/S Shelves & 2 Drawers Epoxy PC Frame	800 mm	500 mm	1015 mm	KH150DD



Economy Instrument Trolley with 2 Drawers (Wide)

- Wide Instrument Trolley with push handles on both sides plus two stainless steel drawers
- Epoxy Coated Frame
- Guard rails on three sides
- Stainless steel shelves

Code	Description	Width	Depth	Height	Supplier Code
WAT807000	Instrument Trolley Wide with 2 Drawers & Epoxy Powder Coated	800 mm	500 mm	1015 mm	KH150D2

- 75 mm twin wheels
- Warranty: 36 months



Premium Instrument Trolley

- Instrument Trolley with push handles on both sides
- Stainless steel or chrome frame
- Guard rails on three sides
- 100mm HD grey swivel contour
- Warranty: 36 months

Code	Description	Width	Depth	Height	Supplier Code
WAT805600	Premium 500 2 S/S Shelves Chrome Frame	500 mm	500 mm	1015 mm	KH141
WAT773400	Premium 600 2 S/S Shelves Chrome Frame	600 mm	500 mm	1015 mm	KH143
WAT807200	Premium 800 2 S/S Shelves Chrome Frame	800 mm	500 mm	1015 mm	KH151
WAT805900	Premium 500 2 S/S Shelves S/S Frame	500 mm	500 mm	1015 mm	KH141S
GSP	Premium 600 2 S/S Shelves S/S Frame	600 mm	500 mm	1015 mm	KH143S
WAT807500	Premium 800 2 S/S Shelves S/S Frame	800 mm	500 mm	1015 mm	KH151S



Premium Instrument Trolley with Drawer

- Instrument Trolley with push handles on both sides plus one stainless steel drawer
- Stainless steel or chrome frame
- Guard rails on three sides
- 100 mm castors
- Buffer Discs (Swivelling)
- Warranty: 36 months

Code	Description	Width	Depth	Height	Supplier Code
WAT805700	Premium 500 2 S/S Shelves & 1 Drawer Chrome Frame	500 mm	500 mm	1015 mm	KH141D
WAT806400	Premium 600 2 S/S Shelves & 1 Drawer Chrome Frame	600 mm	500 mm	1015 mm	KH143D
WAT807300	Premium 800 2 S/S Shelves & 1 Drawer Chrome Frame	800 mm	500 mm	1015 mm	KH151D
WAT806000	Premium 500 2 S/S Shelves & 1 Drawer S/S Frame	500 mm	500 mm	1015 mm	KH141SD
WAT806600	Premium 600 2 S/S Shelves & 1 Drawer S/S Frame	600 mm	500 mm	1015 mm	KH143SD
WAT807600	Premium 800 2 S/S Shelves & 1 Drawer S/S Frame	800 mm	500 mm	1015 mm	KH151SD



Premium Instrument Trolley with 2 Drawers

- Instrument Trolley with push handles on both sides plus two stainless steel drawers
- Stainless steel or chrome frame
- Guard rails on three sides
- Stainless steel shelves
- 100 mm castors
- Buffer Discs (Swivelling)
- Warranty: 36 months

Code	Description	Width	Depth	Height	Supplier Code
WAT805800	Premium 500 2 S/S Shelves & 2 Drawers Chrome Frame	500 mm	500 mm	1015 mm	KH141DD
WAT806500	Premium 600 2 S/S Shelves & 2 Drawers Chrome Frame	600 mm	500 mm	1015 mm	KH143DD
WAT807400	Premium 800 2 S/S Shelves & 2 Drawers Chrome Frame	800 mm	500 mm	1015 mm	KH151DD
WAT806100	Premium 500 2 S/S Shelves & 2 Drawers S/S Frame	500 mm	500 mm	1015 mm	KH141SDD
WAT806700	Premium 600 2 S/S Shelves & 2 Drawers S/S Frame	600 mm	500 mm	1015 mm	KH143SDD
WAT807700	Premium 800 2 S/S Shelves & 2 Drawers S/S Frame	800 mm	500 mm	1015 mm	KH151SDD



Premium Instrument Trolley with 2 Drawers (Wide)

- Wide Instrument Trolley with push handles on both sides plus two stainless steel drawers
- Stainless steel or chrome frame
- Guard rails on three sides
- Stainless steel shelves

Code	Description	Width	Depth	Supplier Code
GSP	Premium 800 2 S/S Shelves & 2 Drawers (side by side) Chrome Frame	800 mm	500 mm	KH151DD
WAT807650	Premium 800 2 S/S Shelves & 2 Drawers (side by side) S/S Frame	800 mm	500 mm	KH151SD2

- 100 mm castors
- Buffer Discs (Swivelling)
- Warranty: 36 months



Instrument Trolley Flat Top

- Flat Topped Instrument Trolley is ideal for theatre use
- Stainless steel frame
- Flat top with rounded corners
- Lightweight robust construction
- 100 mm heavy duty castors and buffer discs
- Buffer Discs (Swivelling)

Code	Description	Width	Depth	Height	Supplier Code
WAT807800	Premium 500 Flat Top 2 S/S Shelves & Stainless Steel Frame	500 mm	500 mm	950 mm	KH152
WAT807900	Premium 800 Flat Top 2 S/S Shelves & Stainless Steel Frame	800 mm	500 mm	950 mm	KH153
WAT808000	Premium 1060 Flat Top 2 S/S Shelves & Stainless Steel Frame	1060 mm	500 mm	950 mm	KH154

- Warranty: 36 months



Lock Option

- Draw lock for instrument trolleys

Code	Description
GSP	Lock Option



Stethoscope Luxury Dual Head

- Well designed economical stethoscope
- Light weight aluminum reversible head & chest piece
- Non chill ring for patient comfort
- Warranty: 12 months

Code	Description
GMD300100	Stethoscope Luxury Dual Head Black
GMD300110	Stethoscope Luxury Dual Head Magenta
GMD300120	Stethoscope Luxury Dual Head Navy Blue



Stethoscope Liberty Classic

- Classic stainless steel stethoscope
- Stainless steel chest piece
- Double inner spring binaural
- Non chill ring and diaphragm-retaining ring for patient comfort
- Warranty: 12 months

Code	Description
GMD300200	Stethoscope Liberty Classic Black
GMD300210	Stethoscope Liberty Classic Magenta
GMD300220	Stethoscope Liberty Classic Navy Blue



Sphygmomanometer Basic

- Palm style sphygmomanometer designed for convenience with left or right handed use
- Large 55 cm dial
- Includes adult cuff plus nylon carry case
- Latex free
- Warranty: 12 months

DVA For eligibility & prescriber info please refer to pg 7.

Code	Description	RAP #:
GMD300280	Sphygmomanometer Basic Aneroid One Hand	AS01



Sphygmomanometer Aneroid

- Hand held Sphygmomanometer features 300 mmHg non stop pin manometer
- Velcro cuff complete with bladder, bulb & valve
- Comes with leatherette zipped case
- Warranty: 12 months

DVA For eligibility & prescriber info please refer to pg 7.

Code	Description	RAP #:
GMD300300	Sphygmomanometer Aneroid	AS01
GMD300305	Sphygmomanometer Aneroid - Large	AS01



Sphygmomanometer Aneroid Erka Switch

- Hand held Sphygmomanometer features outstanding ergonomic design
- Allows for simple adaption for the right or left handed user
- User friendly valve cap for ease of use
- Latex free
- Warranty: 12 months

Code	Description
GMD300310	Sphygmomanometer Aneroid Erka Switch



Sphygmomanometer Digital Semi Auto

- Digital Semi Auto measures systolic and diastolic pressure and pulse
- Easy to read digital display
- Automatic deflation plus automatic off
- Self adjusting D - bar cuff for one handed application
- Warranty: 12 months

Code	Description
GMD300320	Sphygmomanometer Digital Semi Auto



Sphygmomanometer Digital Auto

- Hand held automatic Sphygmomanometer measures systolic and diastolic pressure and pulse
- Features a unique memory of the last 7 readings
- Easy to read digital display
- Warranty: 12 months

DVA For eligibility & prescriber info please refer to pg 7.

Code	Description	RAP #:
GMD300330	Sphygmomanometer Digital Auto	AS01



Blood Pressure Monitor Semi Automatic

- Measures & simultaneously displays Systolic, Diastolic & Pulse
- Semi automatic, one button pressurization, measurement & exhaust
- Automatic power - off function to preserve battery life

DVA For eligibility & prescriber info please refer to pg 7.

Code	Description	RAP #:
GMD332025	Blood Pressure Monitor Semi Automatic	AS01



Sphygmomanometer Aneroid Erka Vario Wall Model

- High quality precision manometer designed to fix directly to a wall
- Housing made from high quality ABS in signal white/light grey
- Manometer features a scale inclined by 12 degrees
- Warranty: 12 month

Code	Description
GMD300380	Sphygmomanometer Aneroid Erka Vario Wall Model



Sphygmomanometer Aneroid Erka Vario Desk Model

- High quality precision manometer designed to sit on a stable, flat surface
- Housing made from high quality ABS in signal white/light grey
- Manometer features a scale inclined by 12 degrees
- Warranty: 12 months

Code	Description
GMD300370	Sphygmomanometer Aneroid Erka Vario Desk Model



Sphygmomanometer Aneroid Erka Vario Trolley Light Weight

- Sold as a kit consisting of mobile trolley with five star base plus quality precision manometer
- Warranty: 12 months

Code	Description
GMD300340	Sphygmomanometer Aneroid Erka Vario Trolley Light Weight
GMD300350	Sphygmomanometer Aneroid Erka Vario Trolley Medium Weight
GMD300360	Sphygmomanometer Aneroid Erka Vario Trolley Heavy Weight



Sphygmomanometer Aneroid

- Available in trolley or wall model
- Large, easy to read 150mm dial
- Nylon velcro cuff, bladder, bulb and valve included
- Also supplied with nickel plated air release valve plus 8ft of coil tubing

DVA For eligibility & prescriber info please refer to pg 7.

Code	Description	RAP #:
GMD333530	Sphygmomanometer Aneroid Trolley Model	AS17
GMD300375	Sphygmomanometer Aneroid Wall Model	AS17



Thermometer Digital Clinical

- Thermometer is easy to read
- Beeps when ready with auto shut off
- Features memory of the last measured temperature
- 100 + hours of battery life
- Warranty: 12 months

Code	Description
GMD300390	Thermometer Digital Clinical
GMD300400	Thermometer Digital Clinical Flexible Tip
GMD300410	Thermometer Digital Clinical Liberty Rapid Read



Thermometer Digital Ear Tympanic

- Measurement temperature range of 33.5 - 42.0 degrees
- Performance of up to 4000 uses with AAA batteries (not included)
- Warranty: 12 months

Code	Description	Length	Width	Depth
GMD300420	Thermometer Digital Ear Tympanic	140 mm	70 mm	40 mm
GMD300430	Replacement Disposable Ear Covers			



Pick-Pocket

- The Pick-Pocket increases efficiency, No more running back and forth for scissors or more tape, measures 20cm x 15cm
- Secure zip compartment for your valuables. Also perfect for carrying your mobile phone or PDA
- Pens and scissors can be safely stored in the Pick-Pocket

Code	Description
GSP	Pick-Pocket



Blood Collection Chair

- Ergonomic chair provides comfort for both patient and medical professional
- Padded armrests and Footrest
- Lumbar supportive backrest
- Warranty: 24 months

Code	Description	Seat Height	Seat Length	Seat Width	Supplier Code
WAT823000	Blood Collection Chair Beige	660 mm	440 mm	450 mm	KH375B
WAT823100	Blood Collection Chair Grey	660 mm	440 mm	450 mm	KH375G



X Ray Viewer

- X - Ray Viewer has a robust epoxy coated mild steel body
- Features double ballast electrical system to extend tube life
- Warranty: 12 months

Code	Description	Length	Width	Height	Supplier Code
WAT819700	X - Ray Viewer Single	395 mm	100 mm	555 mm	KH315S
WAT819500	X - Ray Viewer Double	790 mm	100 mm	555 mm	KH315D
WAT819600	X - Ray Viewer Quad	1580 mm	100 mm	555 mm	KH315Q
WAT819800	X - Ray Viewer Triple	1185 mm	100 mm	555 mm	KH315T

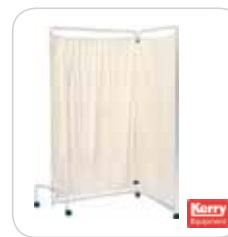

Folding Screen

- Mobile Folding Screen provides privacy for patients
- Folds flat for easy transportation and storage
- Warranty: 12 months

Code	Description	Width	Depth	Height	Supplier Code
WAT825000	Folding Screen 2 Bay Beige	1550 mm	550 mm	1800 mm	KH513B
WAT825100	Folding Screen 2 Bay Grey	1550 mm	550 mm	1800 mm	KH513G
WAT825200	Folding Screen 3 Bay Beige	2300 mm	550 mm	1800 mm	KH514B
WAT825300	Folding Screen 3 Bay Econ	2300 mm	550 mm	1800 mm	KH514E
WAT825400	Folding Screen 3 Bay Grey	2300 mm	550 mm	1800 mm	KH514G



Chart Trolley Mobile

- Spring assisted high/low adjustment
- Easy to operate spring loaded flow chart clips
- 125mm total lock castors offers good manoeuvrability
- Pen holder (full length of table)

Code	Description	Supplier Code
WAT818800	Chart Trolley Mobile	KH240



Mobile IV Stand

- Features stable, five star polyurethane base to minimise staff injury and wall or furniture damage
- Adjustable two point 'Pig Tail' IV attachment

✓ DVA CONTRACTED

AT12 HIRE
Prescribers... LMO/S/RN/OT
For approval rules refer to pg 7.

Code	Description	Base	Height	Supplier Code	✓ RAP #:
WAT819200	Mobile IV Stand - Plastic Base	580 mm	1300 - 2200 mm	KH310P	AT12
WAT819450	IV Stand Mobile Telescopic S/ Steel Pole	500 mm	1300 - 2200 mm	KH314	AT12
WAT819100	Mobile IV Stand - Poly Base	500 mm	1300 - 2200 mm	KH310	AT12
WAT819900	IV Pole Hook 3 Prong			KH31VH3	
WAT820000	IV Pole Hook 4 Prong			KH31VH4	
WAT820100	IV Pole PH			KH31PH	



Mobile IV Stand with Syringe Pump Stand Mount

- Features stable, five star polyurethane base to minimise staff injury and wall or furniture damage
- Mount pole offset from base to ensure syringe pump mounts over the centre of gravity
- Accepts most volumetric infusion pumps, syringe pumps and PCA pumps

✓ DVA CONTRACTED

AT12 HIRE
Prescribers... LMO/S/RN/OT
For approval rules refer to pg 7.

Code	Description	Base	Height	Supplier Code	✓ RAP #:
WAT819300	Mobile IV Stand with Syringe Pump Stand Mount	500 mm	1600 - 2200 mm	KH312	AT12



Syringe Pump Stand Mobile

- Accepts most volumetric infusion pumps, syringe pumps & PCA pumps. The mount pole is offset from the base to ensure the syringe pump mounts over the centre of gravity.
- 6 Star stainless steel base

✓ DVA CONTRACTED

AT12 HIRE
Prescribers... LMO/S/RN/OT
For approval rules refer to pg 7.

Code	Description	Base	Height	Supplier Code	✓ RAP #:
WAT819400	Syringe Pump Stand Mobile	1525 mm	1985 mm	KH313	AT12



Anaesthetic Stool

- Comfortable, height adjustable stool for use in the workplace
- 50 mm twin wheels
- Gas assisted height adjustment
- Padded vinyl seat
- Polished aluminium five star base
- Warranty: 24 months

Code	Description	Height	Supplier Code
WAT803100	Anaesthetic Stool Deluxe with Backrest & Armrests	600 - 850 mm	KH132A
WAT803400	Anaesthetic Stool Deluxe	600 - 850 mm	KH131
WAT803500	Anaesthetic Stool Deluxe with Backrest	600 - 850 mm	KH132
WAT803200	Anaesthetic Stool Economy	600 - 850 mm	KH131E
WAT803300	Anaesthetic Stool Polyurethane Seat	600 - 850 mm	KH131U



Wash Bowl

- Wash bowl is autoclavable for sanitising
- Moulded plastic construction
- Can also be used for bedside commodes



Kidney Dish Clear Plastic Disposable

- Kidney Dish range is used to hold dressings or instruments
- Available in a number of sizes
- Available in clear plastic disposable or green autoclavable for easy sanitising

DVA For eligibility & prescriber info please refer to pg 7.

Code	Description	RAP #:	Code	Description	Capacity
WAT761200	Wash Bowl	BE03	WAT770400	Kidney Dish Clear Plastic Disposable	700 ml
			WAT770500	Kidney Dish Green Autoclavable	200 ml
			WAT770600	Kidney Dish Green Autoclavable	600 ml
			WAT770700	Kidney Dish Green Autoclavable	800 ml



Response Trolley

- Response Trolley is fully equipped to handle any emergency situation
- Hydraulic lift operation and Trendelenburg foot pedals
- Four 200 mm total locking castors
- Full length X - Ray translucent top
- 70 mm seamless Dartex mattress
- Warranty: 24 months

Code	Description	Length	Width	Height	Max. User Weight	Supplier Code
WAT826100	Response Trolley	2200 mm	850 mm	650-950 mm	220 kg	KH607
WAT826200	Response Trolley Adjustable Arm					KH607AA
WAT826300	Response Trolley Fifth Wheel					KH607FW
WAT826400	Response Trolley IV Pole					KH607IV
WAT826500	Response Trolley Knee Break					KH607KB
WAT826700	Response Trolley Mattress (100 mm)					KH607MT
WAT826600	Response Trolley Mattress (70 mm)					KH607M
WAT827100	Response Trolley Monitor					KH607PS
WAT826800	Response Trolley OxygenCarrier					KH607OX
WAT826900	Response Trolley Oxygen Carrier D Oxygen Carrier D					KH607OXD
WAT827000	Response Trolley Push Handle					KH607PH
WAT827200	Response Trolley Raised Monitor Platform					KH607RP
WAT827300	Response Trolley X Ray Cassette					KH607XC



Patient Trolley Hi/Lo Hydraulic

- Full wrap around PVC bumper
- Rapid high/low adjustment - operated with dual foot pedals on both sides Pneumatic assisted 15 degree trendelenburg and reverse trendelenburg
- Pneumatic assisted backrest - fully adjustable to 85 degrees
- Full length self locking folding side rails
- Short wheel base for easy manoeuvrability
- Removable mesh utility baskets
- Four point location / adjustable IV pole
- Undercarriage IV pole storage
- Drop down stainless steel "T" type push handles
- "C" size Oxygen bottle carrier

Code	Description	Length	Width	Height	Supplier Code
WAT827400	Patient Trolley Hi/Lo Hydraulic	2100 mm	780 mm	840 mm	KH608
WAT827500	Patient Trolley Fixed Height w/ Trendelenburg	2100 mm	780 mm	840 mm	KH608FT
WAT827600	Patient Trolley Mattress	1950 mm	600 mm	60 mm	KH608M
WAT827700	Patient Trolley Mattress	1950 mm	600 mm	100 mm	KH608MT
WAT827800	Patient Trolley Top Panel				KH608SST



Weigh Chair Digital

- Ideal for accurate and convenient patient weighing
- Easy to read weight display
- Swivel wheels with safety brakes plus built in footrests
- Easy to clean surfaces essential in health care environments
- 100 hours use from regular batteries

Code	Description	Width	Depth	Height	Warranty	Max. User Weight
LSS377700	Weigh Chair Digital	680 mm	635 mm	880 mm	12 months	150 kg



Weigh Chair Digital Bariatric

- Ideal for accurate and convenient bariatric patient weighing
- Ergonomically designed Digital Weigh Chair is purpose built for the bariatric user
- 500kg weight capacity plus extra large seating capacity
- Portable

Code	Description	Width	Depth	Height	Warranty	Max. User Weight
LSS362500	Weigh Chair Digital Bariatric	800 mm	990 mm	950 mm	12 months	500 kg



Personal Scale Digital

- Personal Digital Scale is portable and features high accuracy rate of 20 grams
- Non-slip weighing platform
- Easy to use keypad

Code	Description	Width	Depth	Height	Warranty	Max. User Weight
LSS377690	Personal Scale Digital	390 mm	712 mm	773 mm	12 months	200 kg



Wheelchair Scale Digital

- Wheelchair Scale with low profile ramp design
- Powder coated steel construction
- Non-slip surface
- Portable

Code	Description	Width	Depth	Warranty	Max. User Weight
LSS362000	Wheelchair Scale Digital	1100 mm	1300 mm	12 months	300 kg

Wheelchairs & Seating



- P 321** Basic Manual Wheelchairs
- P 323** Custom Manual Wheelchair - Overview
- P 335** Power Wheelchair - Overview
- P 346** Wheelchair Cushion - Overview
- P 363** Wheelchair Backrests
- P 369** Wheelchair Accessories - General



OSD Lightweight Wheelchair

- Ideal lightweight wheelchair for home or hospital use
- Swing-away detachable footrests
- 24" quick-release pneumatic rear wheels plus 6" front castors
- Folding frame for easy storage and transportation
- Durable lightweight aluminium
- Features double cross bar and reinforced seat to backrest for added strength
- Supplied with seat cushion
- Accessories include elevating legrests, solid rear tyres, oxygen bottle carrier, anti-tip bars, stump supports
- Warranty: 2 years on frame

DVA CONTRACTED

AP17..... HIRE
Prescribers... Phys/OT/Ch/Ost/S/LMO

AP14..... BUY
Prescribers... Phys/OT/Ch/Ost/S/LMO

For approval rules refer to pg 7.

Code	Description	Colour	Seat Width	Seat Depth	Back Height	Warranty	Frame Wt.	Product Wt.	Max. User Wt.	RAP #:
MWS440100	OSD Lightweight 350 Blue	Blue	350 mm	400 mm	400 mm	24 months	7.4 kg	17.20 kg	100 kg	AP17
MWS440700	OSD Lightweight 350 Silver	Silver	350 mm	400 mm	400 mm	24 months	7.4 kg	17.20 kg	100 kg	AP17
MWS440200	OSD Lightweight 400 Blue	Blue	400 mm	400 mm	400 mm	24 months	7.6 kg	17.40 kg	100 kg	AP17
MWS440800	OSD Lightweight 400 Silver	Silver	400 mm	400 mm	400 mm	24 months	7.6 kg	17.40 kg	100 kg	AP17
MWS440300	OSD Lightweight 450 Blue	Blue	450 mm	400 mm	400 mm	24 months	7.9 kg	17.70 kg	100 kg	AP17
MWS440900	OSD Lightweight 450 Silver	Silver	450 mm	400 mm	400 mm	24 months	7.9 kg	17.70 kg	100 kg	AP17
MWS440500	OSD Lightweight 500 Blue	Blue	500 mm	400 mm	400 mm	24 months	8.1 kg	17.90 kg	100 kg	AP17
MWS441100	OSD Lightweight 500 Silver	Silver	500 mm	400 mm	400 mm	24 months	8.1 kg	17.90 kg	100 kg	AP17
WCA858440	Stump Support, Left									AP14
WCA858450	Stump Support, Right									AP14
WCA858460	Anti Tip Bars - All OSD Chairs									AP14
WCA858455	OSD Lightweight - S/A Legrest Blue									AP14
WCA858451	OSD Lightweight - S/A Legrest Chrome									AP14
WCA858370	Elevating Legrest Blue, Left									AP14
WCA858390	Elevating Legrest Blue, Right									AP14
WCA858420	Elevating Legrest Silver, Left									AP14
WCA858430	Elevating Legrest Silver, Right									AP14



OSD Standard Wheelchair

- Ideal wheelchair for home or hospital use
- Swing-away detachable footrests and removable armrests
- 24" quick-release pneumatic rear wheels plus 8" front castors
- Folding frame for easy storage and transportation
- Available with accessories including elevating legrests, solid rear tyres and oxygen bottle carrier
- Durable steel construction
- Warranty: 2 years on frame

DVA CONTRACTED

AP17..... HIRE
Prescribers... Phys/OT/Ch/Ost/S/LMO

AP14..... BUY
Prescribers... Phys/OT/Ch/Ost/S/LMO

For approval rules refer to pg 7.

Code	Description	Colour	Seat Width	Seat Depth	Back Height	Warranty	Frame Wt.	Product Wt.	Max. User Wt.	RAP #:
MWS441400	OSD Standard 350 Chrome	Chrome	350 mm	400 mm	400 mm	24 months	10.6 kg	18.8 kg	100 kg	AP17
MWS441500	OSD Standard 400 Chrome	Chrome	400 mm	400 mm	400 mm	24 months	10.7 kg	18.9 kg	100 kg	AP17
MWS441200	OSD Standard 450 Blue	Blue	450 mm	400 mm	400 mm	24 months	10.8 kg	19.0 kg	100 kg	AP17
MWS441600	OSD Standard 450 Chrome	Chrome	450 mm	400 mm	400 mm	24 months	10.8 kg	19.0 kg	100 kg	AP17
MWS441300	OSD Standard 500 Blue	Blue	500 mm	400 mm	400 mm	24 months	11.1 kg	19.3 kg	100 kg	AP17
MWS441700	OSD Standard 500 Chrome	Chrome	500 mm	400 mm	400 mm	24 months	11.1 kg	19.3 kg	100 kg	AP17
MWT469840	24" Solid Rear Wheels									-
MWT469850	12" Transit Wheels									-
WCA858360	Elevating Legrest Blue, Left									AP14
WCA858380	Elevating Legrest Blue, Right									AP14
WCA858400	Elevating Legrest Chrome, Left									AP14
WCA858410	Elevating Legrest Chrome, Right									AP14
WCA859770	Oxygen Bottle Carrier									AP14



TOP SELLER

OSD Transit Wheelchair

- Attendant propelled wheelchair ideal for home or hospital use
- Swing-away detachable footrests and removable armrests
- 12" quick-release pneumatic rear wheels plus 8" front castors
- Folding frame for easy storage and transportation
- Available with accessories including elevating legrests and oxygen bottle carrier
- Durable steel construction
- Warranty: 2 years on frame

✓ DVA CONTRACTED

AP17..... HIRE
Prescribers... Phys/OT/Ch/Ost/S/LMO
For approval rules refer to pg 7.

Code	Description	Colour	Seat Width	Seat Depth	Back Height	Warranty	Frame Weight	Product Weight	Max. User Weight	✓ RAP #:
MWS441800	OSD Transit 400	Burgundy	400 mm	400 mm	400 mm	24 months	10.8 kg	16.0 kg	100 kg	AP17
MWS441900	OSD Transit 450	Burgundy	450 mm	400 mm	400 mm	24 months	11.0 kg	16.2 kg	100 kg	AP17
MWS442000	OSD Transit 500	Burgundy	500 mm	400 mm	400 mm	24 months	11.2 kg	16.4 kg	100 kg	AP17



Push Pull Wheelchair

- Single arm propelled wheelchair for home or hospital use
- Push pull lever designed for users with adequate upper limb strength in one arm
- Folding frame for easy storage and transportation
- Swing-away detachable footrests and removable armrests
- 24" quick-release pneumatic rear wheels plus 8" front castors
- Durable steel construction

✓ DVA CONTRACTED

AP19..... HIRE (P.A Rqd)
Prescribers... Phys/OT/S/LMO
For approval rules refer to pg 7.

Code	Description	Colour	Seat Width	Seat Depth	Back Height	Product Weight	Max. User Weight	✓ RAP #:
MWS442400	Push Pull Left 410mm	Chrome	410 mm	410 mm	410 mm	19.5 kg	120 kg	AP19
MWS442500	Push Pull Right 410mm	Chrome	410 mm	410 mm	410 mm	19.5 kg	120 kg	AP19
MWS442600	Push Pull Left 440mm	Chrome	440 mm	410 mm	410 mm	19.5 kg	120 kg	AP19
MWS442700	Push Pull Right 440mm	Chrome	440 mm	410 mm	410 mm	19.5 kg	120 kg	AP19
MWS442800	Push Pull Left 500mm	Chrome	500 mm	410 mm	410 mm	19.5 kg	120 kg	AP19
MWS442900	Push Pull Right 500mm	Chrome	500 mm	410 mm	410 mm	19.5 kg	120 kg	AP19



TOP SELLER

SUNRISE MEDICAL

Heavy Duty & Super HD Wheelchair

- Reinforced wheelchair for bariatric users
- Extra wide seat widths and reinforced construction accommodates larger users
- Moulded composite mag wheels
- Swing-away detachable footrests and removable padded armrests
- Durable chrome-plated steel construction

✓ DVA CONTRACTED

AP17..... HIRE
Prescribers... Phys/OT/S/Ch/Ost/LMO
AP14..... BUY
Prescribers... Phys/OT/Ch/Ost/S/LMO
For approval rules refer to pg 7.

Code	Description	Colour	Seat Width	Seat Depth	Back Height	Product Weight	Max. User Weight	✓ RAP #:
MWS442910	Wheelchair Heavy Duty 20"	Chrome	500 mm	400 mm	400 mm	20.1 kg	136 kg	AP17
MWS442911	Wheelchair Heavy Duty 22"	Chrome	550 mm	450 mm	400 mm	27.2 kg	204 kg	AP17
MWS442912	Wheelchair Heavy Duty 24"	Chrome	600 mm	450 mm	400 mm	27.2 kg	204 kg	AP17
WCA858005	Elevating Legrests for HD							AP14
WCA858007	Stump Support Left for HD							AP14
WCA858008	Stump Support Right for HD							AP14
MWS442902	Wheelchair Super HD 28"	Chrome	700 mm	500 mm	450 mm	37.8 kg	318 kg	AP17
MWS442903	Wheelchair Super HD 30"	Chrome	750 mm	500 mm	450 mm	37.8 kg	318 kg	AP17
WCA858009	Stump Support Left for Super HD							AP14
WCA858010	Stump Support Right for Super HD							AP14
WCA858006	Elevating Legrests for Super HD							AP14



Custom Manual Wheelchair - Overview

Tilt-in-Space Wheelchairs:	Pg
• OSD Relax T.I.S	323
• Quickie IRIS T.I.S	323
Rigid & Folding Wheelchairs:	
Sunrise Medical	
• Adult Rigid & Folding.....	324
• Paediatric Rigid and Folding.....	326
Pride	
• Adult Lightweight Folding.....	328
Otto Bock	
• Adult Rigid & Folding.....	329
• Paediatric Rigid and Folding.....	332
TiLite	
• Titanium Rigid & Folding.....	333

Tilt-in-Space Wheelchairs



TOP SELLER

Consult with Aidacare's C.A.S.E.
(Custom And Specialised Equipment) team for this item.

OSD Relax Tilt In Space

- The Relax Tilt In Space Wheelchair is feature packed designed to deliver comfort & support to the user. The tilt mechanism is designed to redistribute weight from the seat surface to the backrest.
- Adjustable height push handles
- Elevating legrests
- Adjustable head support
- Adjustable height and removable armrests
- Contoured backrest
- Width & depth adjustable seat sizing
- 7" x 1 3/4" solid front castors

DVA CONTRACTED

AP17 HIRE (P.A Rqd)
Prescribers... Phys/OT/Ch/Ost/S/LMO

AP14 BUY
Prescribers... Phys/OT/Ch/Ost/S/LMO

For approval rules refer to pg 7.

- 24" x 1 3/8" rear wheels with puncture proof tyres
- Backrest recline
- Warranty: 2 years on frame

Please note: Pictured with Optional Accessory - Tray Table.

Code	Description	Colour	Seat Width	Seat Depth	Back Height	Frame Wt.	Product Wt.	Max. User Weight	RAP #:
MWS442050	Relax Tilt In Space Wheelchair	Chrome	400 - 450 mm	420 - 480 mm	650 - 1000 mm	21.4 kg	38.8 kg	140 kg	AP17
WCA858465	Relax Tilt In Space - Tray Table								AP14



TOP SELLER



Consult with Aidacare's C.A.S.E.
(Custom And Specialised Equipment) team for this item.

Quickie IRIS (Intelligent Rotation In Space)

- The revolutionary rotation-in-space design provides a smaller rotational arc ideally matching the user's center of gravity
- This combined with up to 60° of posterior rotation and hi-resolution adjustment, provides the ultimate in control, maneuverability, and stability
- The Quickie IRIS offers the latest in multiple tilt ranges, swing-in swing-out hangers, and easy adjustments making it the premiere rotation-in-space chair in its class
- Quickie Iris is approved for use in vehicles.
- The result: an astoundingly lightweight, durable, and easily transportable wheelchair
- Lightweight at 17.8kg (depending on configuration)
- Foot-release tilt actuator removes exposed cables
- Weight capacity to 160kg
- Fully customisable frame widths
- 55-degree weight shift tilt
- Low seat-to-floor heights, from 10.5" to 12.5"
- Multiple specialty options such as reclining backrest; vent-and-battery tray; and one-arm-drive available
- Choice of 70/80/90-degree swingaway footrests
- Choice of 12"/16"/20"/22"/24" quick release or fixed rear wheels
- Choice of 4", 6" or 8" poly castors
- Quickie Time-Fit Growth option within 5 years of purchase

Code	Description	Seat Width	Seat Depth	Warranty	Product Weight	Transport Weight	Max. User Weight
MWC427130	Quickie IRIS	350 - 550 mm	350 - 550 mm	Lifetime (frame)	17.8 kg	13 kg	113 kg (STD) 160kg (HD)

Note: Refer page 327 for Zippie IRIS (paediatric)

Wheelchairs & Seating



Sunrise Medical - Custom Manual Wheelchairs



Adult Rigid & Folding - Range Overview

RIGID				FOLDING				
Quickie Q7	Quickie GT	Quickie GP/GPSA (fixed shown)	Quickie GPV	Quickie Xenon	Quickie 2	Quickie 2 HP	Quickie 2 Lite	Quickie LX
Rigid - Open	Rigid - Open	Rigid - Traditional Fixed or Swing-Away	Rigid - Traditional	Folding - Open	Folding - Traditional	Folding - Traditional	Folding - Open Swing-Away	Folding - Traditional
Refer: Pg 324	Refer: Pg 325		Refer: Pg 325	Refer: Pg 325	Refer: Pg 326	Refer: Pg 326	Refer: Pg 326	

As these wheelchairs are highly customisable, Aidacare have selected a sample to feature in this Catalogue.

Aidacare is able to supply all of these products in all states of Australia.

Please contact your Aidacare C.A.S.E consultant on 1300 133 120 for further advice.

C.A.S.E (Custom And Specialised Equipment)

Where you see this symbol, the product you are looking at could be highly customisable. Please consult with your Aidacare C.A.S.E consultant for guidance on product selection and fitting before ordering.



Hydroformed Castor Housing



4-Link Rear Suspension

QUICKIE Q7 (depending on configuration)



Overview & Features:

- Ultra-lightweight: 5.8kg - 8kg (depending on configuration) with wheels
- The Quickie® Q7 with 7000 Series Aluminium and ShapeLoc Technology combined with a Sleek, Ultra-modern design, lives up to Quickie's reputation for cutting edge design and style
- Ovalized 7000-series aluminium tubing is used in the frame, axle plate, and caster housing in order to create this extremely light-weight wheelchair, without compromising on performance. Its vertical strength decreases frame flex and increases overall rigidity
- Featuring 2 unique frames, the Q7 has the Adjustable frame; allowing for environmental and physical changes and the Active Rigid frame; for the user who knows exactly what he or she wants in a chair
- The Hydroformed Caster Housing creates a unique, streamlined shape and form without compromising adjustability or weight
- Featuring the exclusive 4 link rear suspension with a live axle and independent coil spring system. Allowing a smoother, stable ride over a variety of terrain
- New backrest options include telescoping push handles that provide infinite height adjustability and Ballistic Nylon or 3DX Spacer Fabric upholstery
- Over 20 frame colours and 6 hardware colours can be blended into hundreds of possible custom combinations.
- Lifetime frame warranty

Consult with Aidacare's C.A.S.E.
(Custom And Specialised Equipment) team for this item.

Available Colours:



Frame Style	Rigid - Open	Seat Width	12" to 20"
Standard Weight	8 kg	Seat Depth	12" to 22"
User Weight Capacity	120 kg	Back Angle Adj.	85° to 102°
Fold-Down Back	Yes	Camber	0°, 3°, 6°, 9°
		Tension Adj. Upholstery	Yes

Best Suited by:



JAY Lite Cushion



J3 Mid/Lower Thoracic Backrest



Platform Footrest



Auto-folding Footrest

QUICKIE XENON (depending on configuration)



Overview:

Quickie has combined the latest ultra-light, hydroformed aluminium technology with innovative design and engineering to create the Xenon. At just under 8.4kg assembled and 6kg without wheels the Xenon is one of the lightest folding wheelchairs on the market.

The attention to detail in the design of the Xenon provides a lightweight, efficient driving and handling experience that is easy to fold, lift and transport.

Backrest Options:

- Standard Back
- Tension Adjustable Back
- Ballistic Back Upholstery
- 3DX Upholstery

Features:

- Weighs under 6kg (Frame only)
- Easy one-hand opening
- Quickie Locking System mechanism improves transportability of folded chair
- Stylish designer backrest solutions integrated into the flow of the frame
- Adjustable backrests are easy to adjust from -15° degrees to +18° in 3° increments measured to the frame
- Over 20 frame colours and 6 hardware colours can be blended into hundreds of possible custom combinations
- Lifetime frame warranty

Consult with Aidacare's C.A.S.E.
(Custom And Specialised Equipment) team for this item.

Best Suited by:



JAY Lite Cushion



Seat Width	32 - 46 cm	Seat Height Rear	40 - 50 cm
Seat Depth	34 - 50 cm	Seat Angle	0° to 12°
Back Height	25 - 47.5 cm	Frame Angle	80° & 88°
Back Angle	-15° to +18°	Weight	from 8.4 kg
Seat Height Front	43 - 57 cm	Max. User Weight	125 kg

Quickie GT



Quickie GT is an ultra lightweight single-axle rigid frame chair for maximum strength and performance at the lowest possible weight. Adjustable to the user's specifications, it offers multiple modifications. The GT parts are compatible with the rest of the Quickie manual family and is 10% lighter than before. The Quickie GT is a chair made for performance and durability.



Features:

- Ultra-lightweight from 9.7kg in 16" x 16" configuration
- Quickie GT comes in all seat widths and depths from 12x12" to 20x20" (300-500mm) and your choice of front frame angles
- Lite Spoke wheels are the perfect addition to the GT. The Lite Spoke have a new Quickie hub design and come standard on multiple manual chairs
- New Folding Lockdown Angle Adjustable Backrest provides a back angle adjustment range of 17°, 12°, 7°, 2°, -3°, -8°
- The GT offers 20 frame colour options, and an additional 8 Kolorfusion colours.
- Lifetime Frame Warranty

Consult with Aidacare's C.A.S.E.
(Custom And Specialised Equipment) team for this item.

Quickie GP/GPV (depending on configuration)

The GP line of wheelchairs are ideal for active users who need a chair for everyday use as well as sports activities. At 9.8kg (or 9kg with Titanium axles) the one-piece welded frame offers a solid rigid ride and an overall lighter chair weight.

With a variety of options, the GP series can be customized to fit. Tall, short, long or wide, any individual can find a home in a GP.



Features:

- Ultra-lightweight from 9 - 9.8kg (with titanium axles) with wheels
- Standard with a 70° front frame angle; the GPV front end option tapers inward in a V-like fashion. Both of these features are designed to hold the legs in a tighter position to provide exceptional manoeuvrability
- Adjustable axle positions available for centre of gravity adjustment
- Optional sports-orientated Quickie performance wheels (basketball and tennis)
- Multiple axle plate options such as double slot and amputee are available to meet individual needs
- Camber on the GPV can be adjusted from 0-12° in two degree increments for easier propulsion
- Lifetime Frame Warranty

Consult with Aidacare's C.A.S.E.
(Custom And Specialised Equipment) team for this item.



Quickie 2 & Quickie 2 Lite (depending on configuration)

Recently redesigned to reduce frame weight, and to add versatility, the Quickie 2 is an exceptionally customisable active folding wheelchair.

The modular nature of the Q2 offers multiple front frames and seat rails in combination with an independent cross brace and rear frame. This is important when considering any potential changes in a user's condition, function, growth and/or environment.

Q2 Lite: 12.6kg. (16x16" frame, 24" spoke wheels, armrests, wheel locks and hangers)

Features:

- Lightweight at 13.2kg fully assembled with wheels and std configuration
- Huge range of customisable options, including a full range of footrests, armrests, legrests, wheels and castors, and now front suspension options
- Available in seat widths and depths from 12x12" to 20x20" (300-550mm) and heavy Duty models (to 160kg) are available in frame widths from 18"
- Angle Adjustable Backrest provides multiple back angles and adapts to the user's PSIS (Posterior Superior Iliac Spine) height
- With over 20 caster wheel options, rear wheel, tire and handrim combinations, the Quickie 2 can meet your individual needs
- Lifetime Frame Warranty



Consult with Aidacare's C.A.S.E.
(Custom And Specialised Equipment)
team for this item.

Quickie 2 HP

The Quickie 2HP is a high performance Quickie 2.

Like the Quickie 2, it features a very wide range of options.

Unlike the Quickie 2, its design features a more active ride. With the fixed front frame, slotted caster forks, and a wide selection of performance wheels, the Quickie 2HP has a very rigid chair feel.



Features:

- Lightweight at 11.4kg with wheels but excluding footrests
- Offset axle plate, multi-adjustable caster fork and expanded caster housing. These features double the number of seat-to-floor height adjustments possible on the chair and they also allow for a deeper seat angle
- standard with either a 60° or 70° front frame. Its fixed front-frame construction gives the Quickie 2HP the type of performance found in most high performance rigid chairs
- On 18" - 22" widths Heavy Duty option available that offers a 160kg weight capacity
- Caster housing adjustments allow for true fork alignment when changing seat angles
- Armrest options allow the ability to customize for optimal user support, positioning and transfer needs

Consult with Aidacare's C.A.S.E.
(Custom And Specialised Equipment)
team for this item.

Sunrise Medical - Custom Manual Wheelchairs



Paediatric Rigid & Folding - Range Overview

FOLDING W/TILT	FOLDING		RIGID W/TILT		RIGID	
Zippie TS/ TS SE	Zippie GS/ GS SE	Quickie 2 Kids	Zippie TS/ TS SE	Zippie IRIS / IRIS SE	Zippie Zone	Zippie GS/ GS SE
KEY SELLING POINTS						
<ul style="list-style-type: none"> • Tilt-in-space up to 45° • Lightweight welded aluminium frame construction ideal for portability • Designed to accept the widest possible variety of seating solutions 	<ul style="list-style-type: none"> • Build-in growth system • Available in reverse configuration • Proven design and the highest quality construction for trouble-free durability 	<ul style="list-style-type: none"> • Build in Quickie Trufit Growth Kit • Customisable frame 11"-18" frame width 	<ul style="list-style-type: none"> • Tilt-in-space up to 45° • Lightweight welded aluminium frame construction ideal for portability • Designed to accept the widest possible variety of seating solutions 	<ul style="list-style-type: none"> • Patented rotation-in-space ensure center of gravity always remain in the center of the base • Lightweight • Can be disassembled for transport 	<ul style="list-style-type: none"> • Ultra lightweight • Grow capabilities • Easy adjustments • Cool style 	<ul style="list-style-type: none"> • Build-in growth system • Available in standard configuration shown) • Proven design and the highest quality construction for trouble-free durability
INTENDED CONSUMER						
Juvenile 4 - 16 years old Tilt accepts seating transportability	Juvenile 4 - 16 years old self propelling. reverse wheel configuration optional	Juvenile 4 - 16 years old Folding accepts seating self propelling	Juvenile 4 - 16 years old Tilt accepts seating	Juvenile 4 - 16 years old Tilt (rotation) accepts seating	Juvenile 4 - 16 years old self propelling	Juvenile 4 - 16 years old self propelling accepts reverse wheel configuration optional
Refer: Pg 328		Refer: Pg 328		Refer: Pg 327	Refer: Pg 327	



Series 7000 Aluminium



Hydroformed Caster Housing

ZIPPIE ZONE

Overview:

The Zippie Zone is an ultra-lightweight, fully customisable, paediatric rigid chair with great options including a flip-up footrest, sideguards with built-in hublock access, abducted front frame and inset backrest. The Zone ergonomically fits some of the smallest children, allowing the greatest wheel access for enhanced mobility, with built-in growth capability.

Features:

- Ultra Light: 6.4kg (10x10" w/ wheels)
- Range of "cool" options: Glow (in the dark) frame color, gold anodized parts, folding lock down backrest, Spinerge wheels and a flip-back angle adjustable footplate

- Growth Built-in: 3" of built-in depth growth in the frame; Extra 2" of seat sling upholstery is extendable with growth
- Lightweight wheels and aggressive camber can help with wheel access and user independence
- Hydroformed caster housing creates a unique, streamlined caster housing shape without compromising adjustability or weight.
- Lifetime Warranty on Frame (One-year on parts)

Consult with Aidacare's C.A.S.E.
(Custom And Specialised Equipment) team for this item.

Available Colours:



Chair Weight	6.4 kg	Frame Seat Width	8" to 16"
Weight Capacity (w/o seating)	75 kg	Seat Depth	8" to 18"
Overall Width	Seat width +7"	Back Angle Adj.	-8° to 27°
Tubing Diameter	Oval	Front Seat to Floor Height	14" to 19"
		Rear Seat to Floor Height	13" to 19"

Accessories:



JAY Combi /Soft Combi Cushion



JAY J3 Posterior Backrest



Swing in, Swing Out Hangers



55-degree weight shift tilt

ZIPPIE IRIS

Overview:

The newly upgraded Zippie® IRIS features the revolutionary rotation-in-space design and provides a smaller rotational arc ideally matching the pediatric user's center of gravity.

The Zippie® IRIS now offers swing-in swing-out hangers, and easy adjustments making it the premiere rotation-in-space chair in its class.

Zippie Iris is approved for use in vehicles.

Features:

- Fully customisable frame widths 10-18", depths 10-18"

- Quickie True-Fit Growth option within 5 years of purchase
- 55-degree weight shift tilt
- Low seat-to-floor heights, from 11"
- Angle adjustable folding backrest
- Dual post armrests
- Your choice of 70/80/90-degree swingaway footrests
- Your choice of 12"/16"/20"/22"/24" quick release or fixed rear wheels
- Your choice of 4", 6" or 8" poly castors

Consult with Aidacare's C.A.S.E.
(Custom And Specialised Equipment) team for this item.

Accessories:



JAY - GS (Paediatric)



JAY J2 - Pic. mounted with lateral supports

Chair Weight	10 kg	Frame Seat Width	10" to 18"
Weight Capacity (w/o seating)	75 kg	Seat Depth	10" to 18"
Overall Width	Frame width +8"	Back Angle Adj.	85° to 120°
Tubing Diameter	Frame 1" Seat Raul: 1"	Front Seat to Floor Height	12.5" to 19.5" w/drop seat 11" to 17.5"
		Rear Seat to Floor Height	12.5" to 19.5" w/drop seat 11" to 17.5"



Zippie TS – Folding T.I.S



Zippie TS is a folding tilt in space wheelchair for kids, available with a cross-folding or rigid seat frame.

The cross-folding design allows a more compact folded position ideal for the smallest of car boots. Zippie TS features 45 degrees of tilt and is grows in both width and depth. The frame is fully customisable and configurable, with adjustable back angle and seat heights and is available with a full range of footrests, armrests, legrests, wheels and castor options.



Features:

- Fully customisable growing frame widths 10-18", depths 10-20"
- 45 degree gas tilt
- Angle adjustable folding backrest
- Flip-up armrests
- Your choice of 70/80/90-degree swingaway footrests
- Your choice of 12"/16"/18"/20"/22"/24" quick release or fixed rear wheels
- Your choice of 5", 6" or 8" poly castors
- Basic seating package (MASS Customers only) – standard seat pan and Jay Basic cushion, Jay Basic backrest, Whitmyer 10" Plush Pad on Cobra mount

Consult with Aidacare's C.A.S.E.
(Custom And Specialised Equipment)
team for this item.

Quickie 2 Kids

All Quickie 2 models include a Quickie Tru Fit Growth kit, making it an ideal chair for the growing child.

The Quickie 2 is a fully customisable folding wheelchair and features a large selection of options including a full range of footrests, armrests, legrests, wheels and castors. Quickie 2 is available in 12x12" configuration and accepts most modular seating products. This chair is approved for use in motor vehicles when purchased with the Quickie Transit System.



Features:

- Fully customisable frame dimensions 210 - 550 mm
- Quickie True Fit Growth Kit within 3 years of purchase
- Fully adjustable rear axle and castor forks
- Height adjustable backrest
- Padded swing-away armrests
- 70-degree swing-in/swing-out leg rests with composite footplates and heel loops
- Quick-release Litespoke rear wheels with pneumatic tyres

Consult with Aidacare's C.A.S.E.
(Custom And Specialised Equipment)
team for this item.

Pride Mobility - Custom Manual Wheelchairs

Adult Folding

Litestream® XF



The Litestream® XF ultralight manual wheelchair uses a unique, innovative, rigidizing double X folding frame that delivers the versatility and performance of a rigid frame while folding to a width of only 9" for easy transport. The Litestream XF accepts a broad selection of accessories to meet a wide variety of needs and personal preferences while remaining an excellent overall value. The Litestream XF is also available in an HD configuration that weighs just 39 lbs. and features a cane-to-cane rigidizing bar for added stability.

HD configuration



Ultra-hemi configuration



Consult with Aidacare's C.A.S.E.
(Custom And Specialised Equipment)
team for this item.



Otto Bock - Custom Manual Wheelchairs

Adult Folding:

- Start & Start Comfort 329
- Motus 330

Adolescent:

- Avantgrade..... 330
- Voyager..... 331
- Blizzard..... 331

Paediatric:

- Teeny Plus..... 332
- BRAVO racer..... 332
- Start M6 Junior..... 332



Start

- This entry level custom lightweight folding wheelchair is offered with a large range of accessories and key elements included as standard
- Start is ideal for basic customization and offers adjustment in seat depth for optimal fit
- Optional accessories include height adjustable push handles and armrests, stump supports, elevating legrests, tray and many more
- Special models include a Drum Brake version, a Drum Brake with Reclining backrest version, and a Dual Rim one arm drive version, are also available

Standard Features:

- Flip-up armrests with 1-2cm height adjustment
- Swing-in/swing-out removable footrests
- 24" quick release spoke wheels with solid tyres
- 8" castors

Code	Description	Colour	Seat Width	Seat Depth	Back Height	Warranty	Frame Weight	Product Weight	Max. User Weight
MWC427350	Start 45.5	Silver	455 mm	400 - 460 mm	425 mm	24 months	10.5 kg	15.5 kg	125 kg
MWC427340	Start 40.5	Silver	405 mm	400 - 460 mm	425 mm	24 months	10.5 kg	15.5 kg	125 kg
MWC427352	Start 50.5	Silver	505 mm	400 - 460 mm	425 mm	24 months	10.5 kg	15.5 kg	125 kg
MWC427353	Start 45.5 w/ Drum Brakes	Silver	455 mm	400 - 460 mm	425 mm	24 months	N/A	15.5 kg	125 kg
MWC427354	Start 50.5 w/ Drum Brakes	Silver	505 mm	400 - 460 mm	425 mm	24 months	N/A	15.5 kg	125 kg
MWC427355	Start 45.4 w/ Drum Bakes & Recline	Silver	455 mm	400 - 460 mm	425 mm	24 months	N/A	15.5 kg	125 kg
MWC427356	Start with Dual Rim One Arm Drive	Silver	505 mm	400 - 460 mm	425 mm	24 months	N/A	15.5 kg	125 kg
MWC427440	Start XXL 500	Silver	505 mm	430 - 490 mm	400 - 475 mm	24 months	10.1 kg	17.5 kg	160 kg
MWC427450	Start XXL 550	Silver	555 mm	430 - 490 mm	400 - 475 mm	24 months	10.1 kg	17.5 kg	160 kg
MWC427460	Start XXL 580	Silver	580 mm	430 - 490 mm	400 - 475 mm	24 months	10.1 kg	17.5 kg	160 kg



Start Comfort

- Start Comfort is a step up from Start, offering additional elements such as adjustable backrest height, tension-adjustable backrest upholstery, and adjustable rear axle position for optimal wheelchair setup
- The chair is available in a wide range of sizes and can adjust to a wide variety of seat heights
- A hemi kit is available to allow extra low seat heights and a one-hand activated wheel lock system are readily available
- A dual rim one arm drive kit, or drum brakes are available as a special order

Standard Features:

- Height adjustable backrest
- Tension-adjustable backrest upholstery
- Flip-up armrests with 1-2cm height adjustment
- Swing-in/swing-out removable footrests: 24" quick release spoke wheels with solid tyres
- 6" castors

Code	Description	Colours	Seat Width	Seat Depth	Back Height	Product Weight	Max. User Weight
MWC427360	Start Comfort 380	Silver	380 mm	400 - 460 mm	420 - 470 mm	14.5 kg (12.7 without wheels)	125 kg
MWC427370	Start Comfort 405	Silver	405 mm	400 - 460 mm	420 - 470 mm	14.5 kg (12.7 without wheels)	125 kg
MWC427380	Start Comfort 430	Silver	430 mm	400 - 460 mm	420 - 470 mm	14.5 kg (12.7 without wheels)	125 kg
MWC427390	Start Comfort 455	Silver	455 mm	400 - 460 mm	420 - 470 mm	14.5 kg (12.7 without wheels)	125 kg
MWC427400	Start Comfort 480	Silver	480mm	400 - 460 mm	420 - 470 mm	14.5 kg (12.7 without wheels)	125 kg



Ottobock
QUALITY FOR LIFE

Consult with Aidacare's C.A.S.E.
(Custom And Specialised Equipment)
team for this item.

Motus TOP SELLER

Folding adaptive wheelchair with modular design and removable footrests

- Aluminium tube frame with central crossbrace
- Swing-away footrest holders
- Individual footrests, plastic footplates, angle-adjustable
- 22" and 24" rear wheels
- Different position, track and camber settings of the rear wheels are possible
- Different height settings of the back tubes are possible
- Back upholstery, adaptable
- Wheel lock is designed as pressure-activated or traction-activated wheel lock

Seat Width	355 - 555 mm
Seat Depth	360 - 540 mm
Back Height	300 - 500 mm
Total Width	520 - 720 mm with standard rear wheels 555 - 755 mm with rear wheels with drum brake
Total Height	730 - 109 mm
Total Length	805 - 1110 mm
Armrest Height	210 - 300 mm
Front Seat Height	420 - 520 mm
Rear Seat Height	360 - 520 mm
Weight	Approx. 13 kg
Load Capacity	125 / 140 kg
Lower Leg Length	340 - 520 mm



Ottobock
QUALITY FOR LIFE

Avantgarde 3

- Folding frame customisable active wheelchair with modular structure. Three key versions in the range include: CLT (Lite); CV (Variable); CS (Sporty).
- Aluminium construction with double crossbrace maximises rigidity
- Closed anterior frame with integrated footrest (not available in CV model)
- Adaptable back upholstery and angle-adjustable footplates
- Anterior frame angle of 70° or 80° (not available in CV model) depending on the required knee angle and leg position
- Drive wheel adapter to fine-tune the tipping-point, wheel-base, seat angle, wheel camber, and toe-in
- Steering caster adapter to adjust the anterior seat height and leading/trailing correction

	CLT	CV	CS
Seat Width	32 - 50 mm	32 - 50 mm	32 - 50 mm
Seat Depth	36 - 52 mm	36 - 52 mm	36 - 52 mm
Back Height	25 - 50 mm	25 - 50 mm	25 - 50 mm
Load Capacity	100 kg	140 kg	140 kg
Prod Weight	9 - 10 kg	12 kg	11 kg
Main Application	- Paraplegia - Tetraplegia - Spina bifida - MS - MD	- Hemiplegia - MS - MD - Parkinsons	- Paraplegia - Tetraplegia - Spina bifida - MS - Amputation

Consult with Aidacare's C.A.S.E.
(Custom And Specialised Equipment)
team for this item.



Ottobock
QUALITY FOR LIFE

Avantgarde XXL

Folding wheelchair for active use in compact frame design with removable footrests

- Aluminium frame with double crossbrace
- Aluminium side panels and footrest (no extra charge)
- Optional with offset front frame
- Choice of single-panel footrest or individual footrests, angle-adjustable, swingaway to the outside
- 22", 24" or 26" rear wheels w/ different rear wheel position settings possible
- Possible wheel camber setting of 0°, 2° or 4°
- Continuously adjustable caster journal angle up to 15° seat inclination
- Standard version includes adjustable back upholstery, different possible back height settings and push handles

	VR	XXL
Seat Width	320 - 500 mm	500 - 620 mm
Seat Depth	360 - 480 mm	700 - 1035 mm
Back Height	250 - 500 mm	400 - 560 mm
Width	480 - 700 mm	790 - 1140 mm
Total Height	580 - 1100 mm	250 - 500 mm
Length	705 - 880 mm	From 260mm
Variable Armrest Height	200 - 300 mm	66.5 - 820 mm
Seat Height (front/rear)	400 - 560 mm 370 - 530 mm	450 - 535 mm /400 - 535 mm
Weight/Load Capacity	11.8/125 kg	15.2/180 kg
Back angle/Ergo back	+9° to -9°	200 - 300 mm
Lower Leg Length	160 - 550 mm	160 - 550 mm

Consult with Aidacare's C.A.S.E.
(Custom And Specialised Equipment)
team for this item.



Ottobock
QUALITY FOR LIFE

Voyager & Voyager Life

Rigid frame wheelchair for active use

- Open frame construction
- Continuously adjustable centre of gravity
- Individual setting possibilities: seat inclination, back angle
- Wheel camber is selectable from 0° to 15° in increments of 3°
- Optional front frame offset

Voyager Light Edition:

- Infinity rear wheels
- Aluminium footrest bars
- Breathable, light back upholstery
- Aluminium screws

Consult with Aidacare's C.A.S.E.
(Custom And Specialised Equipment)
team for this item.

Front frame angle 75°

Seat Width	320 - 460 mm
Seat Depth	360 - 480 mm
Back Height	250 - 450 mm
Fixed/variable armrest	225 - 315 mm /400 - 530 mm
Seat height (front/ rear)	400 - 555 mm
Width	520 - 975 mm
Total height	610 - 1160 mm
Length	745 - 965 mm
Weight/ load capacity	From 9.8/120 kg
Weight/load capacity light edition	From 9 kg/120 kg
Back angle	63°/105°
Lower leg length	360 - 520 mm

Noted: Front frame angle adjustable to 85°
and changes seat height to 433 - 530 mm



Ottobock
QUALITY FOR LIFE

Blizzard

Rigid frame wheelchair for active use

- Extremely stable aluminium construction
- Continuous centre of gravity adjustment
- Different back angle, seat angle and seat height settings are possible
- Backrest foldable for transport; side panels automatically slide down
- Different front frame angles as well as offset frame available
- Multiple award-winning design
- Vast range of options

Consult with Aidacare's C.A.S.E.
(Custom And Specialised Equipment)
team for this item.

Seat Width	320 - 460 mm
Seat Depth	360 - 480 mm
Back Height	250 - 500 mm
Weight	Approx. 9.5 kg
Front Seat Height	430 - 530 mm
Rear Seat Height	380 - 520 mm
Max. User Weight	120 kg
Front Frame Angle	75°/85°



Ottobock
QUALITY FOR LIFE

Avantgarde Teen 2 & Teen 2 VR

Folding wheelchair for active use for children, youths and small adults

- Aluminium tube frame with crossbrace
- Abduction frame (60 mm) can be selected
- Aluminium footrest, choice between single-panel footrest or individual footrests
- Back is adaptable and different height settings are possible
- Aluminium side panels
- Fixed footrest holders
- Rear frame can be adapted to grow with the user (+20 and +40 mm)
- Rear wheels with quick-release axles
- Wheel lock

Teen 2 VR Features:

- Swing-away removable footrest holders
- Seat depth: 300 - 400 mm
- Seat width: 260 - 360 mm
- Lower leg length: 250 - 410 mm

Seat Width	220 - 360 mm
Seat Depth	240 - 400 mm
Total Width	460 - 665 mm
Back Height	175 - 400 mm
Total Height	635 - 1080 mm
Length	680 - 940 mm
Folding size	From 260 mm
Variable Armrest Height	210 - 300 mm
Weight/load Capacity	10/90 kg
Seat Height (front/rear)	410 - 520 mm/ 350 - 480 mm
Lower Leg Length	160 - 450 mm
Back Angle	-9° to +9°

Consult with Aidacare's C.A.S.E.
(Custom And Specialised Equipment)
team for this item.



Otto Bock
QUALITY FOR LIFE

Teeny Plus

Wheelchair for active use that can be adapted to grow with the user; for children and youths

- Aluminium tube frame with telescoping crossbrace, different settings are possible
- Seat width and seat depth can be adapted to the user's growth – without changing parts
- Aluminium footrest, choice between single-panel footrest or individual footrests
- Back upholstery, adaptable
- Rear wheels with quick-release axles
- 8 rear wheel position settings with wheel lock

Seat Width	230 - 335 mm
Seat Depth	240 - 365 mm
Total Width	460 - 725 mm
Back Height	250 - 350 mm
Total Height	645 - 1065 mm
Length	680 - 1000 mm
Folding Size	From 330 mm
Fixed/Variable Armrest Height	170 - 270 mm
Weight/Load Capacity	11/50 kg
Seat Height (front/rear)	375 - 490 mm / 345 - 470 mm
Lower Leg Length	150 - 430 mm

Consult with Aidacare's C.A.S.E.
(Custom And Specialised Equipment) team for this item.



Otto Bock
QUALITY FOR LIFE

BRAVO racer

Rigid frame wheelchair for active use for children and youths

- Aluminium frame with rigid chassis
- Front frame with wide abduction
- Extremely stable single-panel footplate construction
- Different seat height, seat depth, back position, back angle and centre of
- gravity settings are possible
- 20", 22" and 24" rear wheels for all frame lengths
- Folding backrest
- Clothing protector side panels included
- Wheel lock lever in the side panel
- Large selection of options and colours
- Optional Gecko design

Seat Width	200 - 360 mm
Seat Depth	240 - 380 mm
Total Width	470 - 660 mm
Back Height	175 - 200 mm
Total Height	515 - 910 mm
Length	665 - 865 mm
Optional Armrests	Yes
Back angle	-15°/+15°
Weight	8.5 kg
Seat Height	320 - 510 mm
Lower Leg Length	150 - 440 mm
Load Capacity	60 kg

Consult with Aidacare's C.A.S.E.
(Custom And Specialised Equipment) team for this item.



Otto Bock
QUALITY FOR LIFE

Start M6 Junior

- Aluminium tube frame
- All main component groups are attached with screws
- Standardised caster forks for all wheel sizes
- Durable upholstery
- Different seat depth settings are possible
- Children's colours
- Optimised wheel lock
- Footplate for short lower leg length

Seat Width	280 - 380 mm
Seat Depth	310 - 370 mm
Seat Height (front/rear)	395 - 520 mm / 370 - 520 mm
Weight	From approx. 13.5 kg
Back Height	300 - 375 mm
Lower Leg Length	160 - 470 mm
Max. Load Capacity	90 kg

Consult with Aidacare's C.A.S.E.
(Custom And Specialised Equipment) team for this item.



Ti Life - Custom Manual Wheelchairs



Rigid & Folding - Range Overview

RIGID				FOLDING				
KEY SELLING POINTS								
TR	ZR	ZRa	AeroZ	AeroR	TX	2GX	AeroX	SxX
<ul style="list-style-type: none"> 1" Titanium Dual-Tube Frame Revolutionary Frame Design Provides the ultimate Performance & Portability Adjustable Bullet Caster Housing 5 Colour Anodize Packages 	<ul style="list-style-type: none"> 1.25" Titanium Mono-Tube Frame Z" Frame Maximizes Portability Adjustable Bullet Caster Housing Fixed or Welded Components 5 Colour Anodized Packages 	<ul style="list-style-type: none"> 1.25" Titanium Mono-Tube Frame Z" Frame Maximizes Portability Adjustable Bullet Caster Housing Tru-Fit System 5 Colour Anodized Packages 	<ul style="list-style-type: none"> 1.25" 6061 T6 Aluminum Mono-Tube Frame Adjustable Bullet Caster Housing Tru-Fit System Reduces 14 Frame Color Options 5 Colour Anodized Packages 	<ul style="list-style-type: none"> 1" 6061 T6 Aluminum Frame Tru-Fit System Adjustable Bullet Caster Housing 	<ul style="list-style-type: none"> 1" Titanium Frame Rigid Folding Mechanism Bullet Caster Housing Adjustable Center of Gravity 5 Colour Anodized Packages 	<ul style="list-style-type: none"> 1" Titanium Frame Tru-Fit System Bullet Caster Housing Rigid Folding Mechanism 	<ul style="list-style-type: none"> 1" 6061 T6 Aluminum Frame Tru-Fit System Adjustable Bullet Caster Housing Reduced Weight and Adds Style Rigid Folding Mechanism 	<ul style="list-style-type: none"> 1" Titanium Frame Full Adjustability Folding Mechanism w/ Lockouts for Superior Rigidity Solid One Piece Side Frame
Refer: Pg 333			Refer: Pg 334		Refer: Pg 334			

As these wheelchairs are highly customisable, Aidacare have selected a sample to feature in this Catalogue.

Please note: Aidacare is unable to supply these products in certain areas.

Please contact your Aidacare C.A.S.E consultant on 1300 133 120 for further advice and availability.

C.A.S.E (Custom And Specialised Equipment)

Where you see this symbol, the product you are looking at could be highly customisable.

Please consult with your Aidacare C.A.S.E consultant for guidance on product selection and fitting before ordering.



TiLife TR (Rigid)

Range Overview:

The frame design of the TR, with an upper and lower frame tube (unlike a "Z" frame), means the TR maintains maximum rigidity. Because of the frame design a smaller diameter titanium tubing can be used to reduce overall weight.

The TR is a high performance wheelchair in every way.

3-2.5 seamless aerospace grade titanium provides superior vibration dampening, reducing user fatigue by creating a smoother ride. The TiLife TR delivers the super smooth ride typical of titanium while being incredibly light and compact.

Features:

- Weight (without rear wheels) approx. 4.5kgs (in a 16 x 16" chair)
- 1" Aerospace Grade Titanium
- Dual-Tube Frame provides the maximum rigidity with low weight
- Bullet Caster Housing Reduces Weight with a Stylized Look
- 5 Color Anodize Packages
- Cross bar design ensures the TX folds to minimal width
- Optional flip-back footrest
- Huge range of accessories and options available including: Jetstream Pro back; soft roll front castors; anti-tip castors; anodized colours on front castors and camber bar; Spinergy rear wheels and much more
- Every TR is handmade to each client's exact specifications
- Max user weight 113kg
- Lifetime frame warranty

Common Cushions:

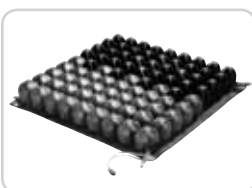

Roho Low Profile Dual Compartment or Quadro Select



Roho Harmony



Dual-Tube Frame Design

Consult with Aidacare's C.A.S.E.
(Custom And Specialised Equipment) team for this item.



TiLite TX (Folding)

Overview:

The latest in folding chair technology. The new TiLite TX was developed to meet the demands of the most particular wheelchair users.

Now available with fold down back; RFM (Rigid Folding Mechanism) cross-brace design; and Bullet castor housing; the TX delivers a stronger, lighter and more rigid folding chair.

The new TiLite TX delivers the super smooth ride typical of titanium while being incredibly light and compact.

Features:

- Weight (without rear wheels) approx. 4.8kgs (in a 14 x 14" chair)
- Cross bar design ensures the TX folds to minimal width.
- Fixed footrest hangers
- Huge range of accessories and options available including: fold down back; fold down push handles; soft roll front castors; Natural Fit Handrims; anti-tip castors; anodized colours on front castors and camber bar; Spinegy rear wheels and much more. 3-2.5 seamless aerospace grade titanium provides superior vibration dampening, reducing user fatigue by creating a smoother ride
- Every TX is handmade to each client's exact specifications.
- Max user weight 113kg
- Lifetime frame warranty



Consult with Aidacare's C.A.S.E.
(Custom And Specialised Equipment) team for this item.

Common Cushions:

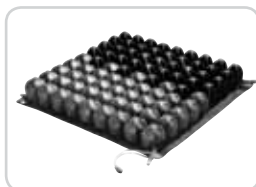

Roho Low Profile Dual Compartment or Quadro Select



Roho Harmony



Aero Z

Overview:

Innovative technology and design from the TiLite titanium line have been applied to the Aero Z in aluminium.

The TiLite Aero Z is a completely custom made, ultra lightweight aluminium chair.

The Aero Z offers a wide array of options that improve fit and performance for the user.

Features:

- 1.25" mono-tube aluminum
- The Tru-Fit system makes changing the center of gravity quick and easy. Tru-Fit also reduces frame holes for enhanced durability and clean profile.
- Frame Type: Folding/Rigid Hybrid
- Weight capacity: 113 kg
- Starting Weight: 6 kg

Consult with Aidacare's C.A.S.E.
(Custom And Specialised Equipment) team for this item.



Common Cushions:

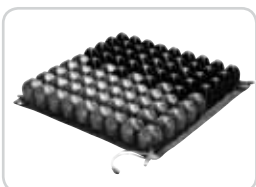

Roho Low Profile Dual Compartment or Quadro Select



Roho Harmony



Power Wheelchair - Overview

Basic Power Wheelchairs:	Pg
• Pride Mobility.....	335
Custom Power Wheelchairs:	
Pride Mobility	
• Quantum Adult Power.....	337
• Quantum Paediatric Power.....	339
Sunrise Medical	
• Quickie Power.....	340
• X series Power.....	342
Otto Bock	
• Adult Power.....	343
• Skippie Paediatric Power.....	345

Basic Power Wheelchairs



Go Chair

- A lightweight power chair, designed for users with low seating and positioning needs
- Small turning radius - ideal for confined spaces
- Folding design pulls apart for easy transportation
- Swivel seat and flip back armrests assist with transfers
- Designed for indoor use only

✓ **DVA CONTRACTED**
AP16..... HIRE (P.A Rqd)
Prescribers... OT/S/LMO
For approval rules refer to pg 7.

Code	Description	Total Length	Total Width	Maximum Speed	Max. User Wt.	✓ RAP #:
PWS654200	Go Chair	760 mm	470 mm	5.5 km/h	113 kg	AP16



Jazzy 600

- Medium sized mid wheel drive chair
- Advanced suspension for comfort indoors and out
- Nylon OMNI-casters front and rear designed to prevent hang-ups
- Supplied with vehicle tie-downs and manual wheel locks
- Comfortable, high backed seat - optional flat seat pan to accommodate specialised cushions
- Designed for moderate indoor and outdoor use

✓ **DVA CONTRACTED**
AP16..... HIRE (P.A Rqd)
Prescribers... OT/S/LMO
For approval rules refer to pg 7.

Code	Description	Total Length	Total Width	Max. User Wt.	✓ RAP #:
PWS654210	Jazzy 600	895 mm	600 mm	155 kg	AP16



Jazzy Select

- Highly manoeuvrable, non folding, power wheelchair
- Two motor, inline, mid wheel drive
- Comfortable, high backed seat
- Large flip-up foot board
- Black non-scuffing tyres
- On board charger and easy to use left or right-hand joystick
- Designed for indoor and minimal outdoor use

✓ **DVA CONTRACTED**
AP16..... HIRE (P.A Rqd)
Prescribers... OT/S/LMO
For approval rules refer to pg 7.

Code	Description	Total Length	Total Width	Maximum Speed	Max. User Wt.	✓ RAP #:
PWS654245	Jazzy Select	890 mm	595 mm	6 km/h	139 kg	AP16
PWS654250	Jazzy Select 14XL	965 mm	630 mm	6.5 km/h	181 kg	AP16



Jet 3 Ultra

- Highly manoeuvrable, non folding, power wheelchair
- Compact size for superior handling in tight quarters
- Designed for users with minimal / low seating and positioning needs
- Comfortable, high backed seat - optional flat seat pan
- to accommodate specialised cushions
- Supplied with vehicle tie-downs and manual wheel locks
- Designed for indoor and some outdoor use on stable terrain

DVA CONTRACTED

AP16..... HIRE (PA Rqd)
Prescribers... OT/S/LMO

For approval rules refer to pg 7.

Code	Description	Total Length	Total Width	Maximum Speed	Max. User Weight	RAP #:
PWS654240	Jet 3 Ultra	900 mm	580 mm	6 km/hr	136 kg	AP16
PWS654230	Jet 3 Ultra with Power Seat	900 mm	580 mm	6 km/hr	136 kg	AP16



R4

- Economy, folding power chair designed for indoor and some outdoor use on stable terrain
- Folding design allows for easy transportation
- Designed for users with minimal/low seating and positioning needs
- Rear wheel drive power

DVA CONTRACTED

AP16..... HIRE (PA Rqd)
Prescribers... OT/S/LMO

For approval rules refer to pg 7.

Code	Description	Seat Width	Total Length	Total Width	Maximum Speed	Max. User Weight	RAP #:
PWS654280	R4	450 mm	1092 mm	615 mm	6.4 km/h	113 kg	AP16

PRIDE Power Wheelchair Accessories

Code	Description	RAP #:
WCA858222	Basket – Rear basket for Jet 3 Ultra	AP14
WCA858200	Belt – 50” Lap Belt for Power Wheelchair	AP14
WCA858205	Belt – 60” Lap Belt for Power Wheelchair	AP14
WCA858340	Pommel – Flip Down w/ 2” Pad	AP14
WCA858330	Pommel – Flip Down w/ 4” Pad	AP14

REFER TO PAGE 369 FOR ALL OTHER
WHEELCHAIR ACCESSORIES





Pride Quantum Power Chairs - Overview

Quantum Power Chairs deliver exceptional maneuverability, high-performance operation and superb rehab capability. Compatible with a wide range of rehab electronics and seating options like TRU-Balance® Power Positioning Systems, Quantum Power Chairs are designed to meet the needs of even the most active rehab client.



Overview:

- **Q6 Series** – Mid & Rear wheel drive power wheelchairs
- **Q-Logic Drive Control Systems** – Curtis Controls technology
- **Seating Systems & Cushions** – Tru-Balance; Tru-Comfort & Synergy

Quantum® Q6Edge



Overview:

The latest powerchair in the Quantum range, the Q6 Edge® supercedes the Q600® offering superior drive, and functionality similar to the Q600z but at a more economical price.

Fully compatible with the Tru-balance seating system and equipped with ATX suspension the Q6 Edge offers comprehensive seating options with high levels of stability.

Features:

- Offers the complete rehab package at exceptional value.
- High Torque 4-pole motor delivers more power at low speeds with less wear-and-tear on the motor
- 6-Drive ensures maximum stability by maintaining 6-wheels in surface contact
- ATX Suspension (Active-Trac with extra stability) incorporates the front castors for enhanced performance over wider terrain
- Compatible with full range of TRU-Balance; TRU-Logic and Q-Logic systems
- Low impact OMNI castors on front and rear wheels prevent wheel hang-ups

Consult with Aidacare's C.A.S.E.
(Custom And Specialised Equipment)
team for this item.

Weight Capacity	136 kg
Range per Charge	25 km
Motor Package	Mid-wheel 6; 4-pole
Max Speed	10 km/h
Turning Radius	50 cm
Available w/ Manual Recline	Yes



TRU-Balance Seating



Quantum Rehab® Power Chairs (cont.)

Quantum® Q6000z

Pride
Mobility Products
Australia Pty. Ltd.



The Quantum® 6000Z utilizes powerful 4-pole motors for maximum torque and patent-pending Mid-Wheel 6® design for aggressive outdoor performance and precision indoor maneuverability. The Quantum 6000Z accepts a broad range of exclusive seating and electronics options for excellent adaptability and rehab capability.



Consult with Aidacare's C.A.S.E.
(Custom And Specialised Equipment)
team for this item.

Features:

- User weight capacity of 136 kg
- Mid-Wheel 6® allows six wheels on the ground for stability
- Patent-pending ATX Suspension (Active-Trac® with extra stability) incorporates front OMNI-Casters for enhanced performance over more varied terrain
- Compatible with TRU-Balance® Power Positioning
- Maximum speed of 12 km/h with optional high-speed motor package
- Standard 8 amp, off-board charger
- Available with Accu-Trac Advanced Tracking Technology
- Also available: Q6400Z Group 4 Power Chair Series

Quantum® Q6000Z HD

Pride
Mobility Products
Australia Pty. Ltd.



The Quantum® 6000Z HD utilizes powerful 4-pole motors for maximum torque and patent-pending Mid-Wheel 6® design for aggressive outdoor performance and precision indoor maneuverability. The Quantum 6000Z HD accepts a broad range of exclusive seating and electronics options for excellent adaptability and rehab capability.



Consult with Aidacare's C.A.S.E.
(Custom And Specialised Equipment)
team for this item.

Features:

- User weight capacity of 204 kg
- Mid-Wheel 6® allows six wheels on the ground for stability
- Patent-pending ATX Suspension (Active-Trac® with extra stability) incorporates front OMNI-Casters for enhanced performance over more varied terrain
- Compatible with TRU-Balance® HD Tilt
- Standard 8 amp, off-board charger

Quantum® Q600

Pride
Mobility Products
Australia Pty. Ltd.



The Quantum® 600 delivers the stability of patent-pending Mid-Wheel 6® design and superb maneuverability, along with a powerful drivetrain for enhanced performance and torque. The Quantum 600 accepts a wide range of seating and electronics options, making it fully rehab capable.



Consult with Aidacare's C.A.S.E.
(Custom And Specialised Equipment)
team for this item.

Features:

- User weight capacity of 136 kg
- Mid-Wheel 6® allows six wheels on the ground for stability
- Patent-pending ATX Suspension (Active-Trac® with extra stability) incorporates front OMNI-Casters for enhanced performance over more varied terrain
- Compatible with TRU-Balance® Power Positioning
- Maximum speed of 9.6 km/h with optional high-speed motor package
- Standard 8 amp, off-board charger
- Available with Accu-Trac Advanced Tracking Technology
- Also available: Q640 Group 4 Power Chair Series

Quantum® 600XL(HD)

Pride
Mobility Products
Australia Pty. Ltd.



The Quantum® 600 XL features patent-pending Mid-Wheel 6® design, an increased weight capacity of 181 kg and enhanced seating available up to 24" x 24". The Q600 XL is the perfect heavy-duty choice for those who demand maximum stability and true all around performance.



Consult with Aidacare's C.A.S.E.
(Custom And Specialised Equipment)
team for this item.

Features:

- Weight capacity of 181 kg
- Mid-Wheel 6® allows six wheels on the ground for stability
- Patent-pending ATX Suspension (Active-Trac® with extra stability) incorporates front OMNI-Casters for enhanced performance over more varied terrain
- Compatible with TRU-Balance® HD Tilt
- Powerful Glide motors for added power and torque
- Standard 8 amp, off-board charger



Quantum Paediatric

Sparky



The Sparky is the brand new Paediatric Power Chair from Quantum. Rear-wheel drive simplifies steering characteristics for the child and two controller options (Q Logic or PR2) provide plenty of flexibility to suit the user.

The Sparky comes standard with swing-away controller mount 30 deg. Two colour options: white (pictured) or silver.



Consult with Aidacare's C.A.S.E.
(Custom And Specialised Equipment) team for this item.

Features:

- Standard Seat widths range from 10 x 10" - 14 x 14"
- Power Tilt 30° as standard
- Manual Recline function
- 7.6cm solid anti-tips
- Speed up to 9.66 km/h allows the child to keep up with friends.
- Large 20cm solid front castors increase terrain capabilities.

Quantum® 6000Z



The Quantum® 6000Z delivers grown-up power and performance in an easy-to-use package that's up for any challenge a kid can put it through. Limitless rehab capability, powerful 4-pole motors and the unmatched maneuverability of patent pending Mid-Wheel 6® design, make the Quantum 6000Z an excellent choice for the classroom, playground and beyond.



Consult with Aidacare's C.A.S.E.
(Custom And Specialised Equipment) team for this item.

Features:

- Mid-Wheel 6® allows six wheels on the ground for stability
- Patent-pending ATX Suspension (Active-Trac® with extra stability) incorporates front OMNI-Casters for enhanced performance over more varied terrain
- Compatible with TRU-Balance® Power Positioning
- Maximum speed of 12 km/h with optional high-speed motor package
- Standard 8 amp, off-board charger

Quantum® 600



Compact, patent-pending Mid-Wheel 6® design and powerful Glide motors let the Quantum® 600 keep up with today's active kids. The Quantum 600 is versatile enough to meet highly unique pediatric requirements while delivering the high-performance needed to keep up with a jam-packed schedule.



Consult with Aidacare's C.A.S.E.
(Custom And Specialised Equipment) team for this item.

Features:

- Mid-Wheel 6® allows six wheels on the ground for stability
- Patent-pending ATX Suspension (Active-Trac® with extra stability) incorporates front OMNI-Casters for enhanced performance over more varied terrain
- Compatible with TRU-Balance® Power Positioning
- Maximum speed of 9.66 km/h with optional high speed motor package
- Standard 8 amp, off-board charger

Quantum® 610



Compact, patent-pending Mid-Wheel 6® design and powerful Glide motors let the Quantum® 610 keep up with today's active kids. The Quantum 610 is versatile enough to meet even the most unique pediatric requirements while delivering the high-performance needed to keep up with a jam-packed schedule.



Consult with Aidacare's C.A.S.E.
(Custom And Specialised Equipment) team for this item.

Features:

- Mid-Wheel 6® allows six wheels on the ground for stability
- Patent-pending ATX Suspension (Active-Trac® with extra stability) incorporates front OMNI-Casters for enhanced performance over more varied terrain
- Compatible with TRU-Balance® Power Positioning
- Maximum speed of 6 km/h
- Standard 5 amp, off-board charger

C.A.S.E (Custom And Specialised Equipment)

Where you see this symbol, the product you are looking at could be highly customisable. Please consult with your Aidacare C.A.S.E consultant for guidance on product selection and fitting before ordering.



Sunrise Medical Power Chairs - Overview



Aspire M11/ F11	Pulse 6	Salsa	Rhythm	Groove	P-222	F-55	Xperience	Xplore	Xcel	Pulse Kidz
Mid	Mid	Rear	Rear	Rear	Rear	Rear	Mid	Rear	Mid	Mid
Refer: Pg341	Refer: Pg340	Refer: Pg341	Refer: Pg340	Refer: Pg341	Refer: Pg341	Refer: Pg341	Refer: Pg342	Refer: Pg342	Refer: Pg342	

As these wheelchairs are highly customisable, Aidacare have selected a sample to feature in this Catalogue. Aidacare is able to supply all of these products in all states of Australia. Please contact your Aidacare C.A.S.E consultant on 1300 133 120 for further advice.

C.A.S.E (Custom And Specialised Equipment)

Where you see this symbol, the product you are looking at could be highly customisable. Please consult with your Aidacare C.A.S.E consultant for guidance on product selection and fitting before ordering.



Quickie Rhythm



The Quickie® Rhythm™ is one of the most advanced power chairs in today's marketplace. Features like 6-Form Suspension™ and Leveler™ technology provide superior comfort when travelling over rough terrain.

The Rhythm also features a group of sophisticated seating systems, such as the ASAP™ seating system with SPOT (Single Power Option Tilt) backrests, that are specifically designed for complex clinical power seating applications.

Features:

- Innovative force steering
- 6-form Suspension™ (all 6-wheels have independent suspension) keeps each wheel in constant contact with the ground
- Leveler™ technology dampens forward pitching allow the Rhythm™ to smoothly traverse rough terrain and travel downhill whilst maintaining comfort
- High output 4-pole motors help the Rhythm™ climb 3" curbs, and maintain a balanced profile when turning at high speeds. Top Speed of 10.5kph
- Lower leg-length actuator allows users to lower their footrests to the ground to assist with transfers
- R-net Electronics & colour screens with easy-to-access options and parameter settings
- Adjustable Seating And Positioning (ASAP) system is available with a power tilt option
- Lifetime Frame Warranty



R-net Electronics

Consult with Aidacare's C.A.S.E.
(Custom And Specialised Equipment) team for this item.

Drive Wheel Position	Mid
Maximum Speed	10.5 kph
User Weight Capacity	136 kg
Overall Base Width	25.5"
Overall Length	39"
Suspension	6-Form™



Quickie Pulse 6

The Quickie Pulse 6 combines comfort and performance in an aesthetically pleasing, proven design. Available with or without power tilt, the Pulse 6 is a compact, durable power wheelchair that offers a wide range of effective seating and electronics options.

Features:

- Sunrise ASAP seat system compatible and Tilt (SPOT) compatible
- Top speed of 10.6 kph with great stability control
- Proven and reliable Linux motors
- Features one of the smallest footprints in its class
- JAY SPO and ART SPO backrest systems
- Full-colour R-net electronics
- Lifetime Frame Warranty

Consult with Aidacare's C.A.S.E.
(Custom And Specialised Equipment) team for this item.



Quickie Salsa

The Quickie Salsa, a mid range rear wheel drive power wheelchair features compact dimensions for great indoor mobility with performance for outdoor freedom. Salsa offers low seat to floor height, transit tie down brackets, a fully adjustable seating system and a wide range of powered seat options that can be easily added as client needs change.

Features:

- 3" of ground clearance (for thresholds, ramps, kerbs and rough terrain)
- 14" wheels for rough terrain
- Compact dimensions also make the Quickie Salsa great for indoor use
- Easy transfer with flip-up arms, low seat-to-floor height and detachable swing-away legrests
- Fully adjustable seating system with retro-fittable options for easy assessment, refurbishment and servicing
- Fully transit tested
- Central batteries to improve stability
- Lifetime Frame Warranty



Consult with Aidacare's C.A.S.E.
(Custom And Specialised Equipment) team for this item.

	Turning	Ground Clearance	Chair Width	Chair Length	Chair Weight	Max. Weight	Batteries	Speed	Angle of Climb	Kerb Climb
12" Wheels	85 cm	7 cm	58 cm	114 cm	115 kg	140 kg	60 amp	6 kph	8°	8.5/4 cm
14" Wheels	91 cm	8 cm	61 cm	114 cm	115 kg	140 kg	60 amp	6 kph	8°	10/5 cm

Quickie F55 Powerchair

Suitable for both outdoor and indoor use the modular design of the F55 lends itself well to accept a variety of seating systems and a number of powered options too

Features:

- Adjustable rear suspension provides for a comfortable ride even on unlevelled surfaces
- Kerb Climber (optional): Increased accessibility, as up to 10cm (4") kerbs can be mounted
- Swing away controller. Helps you get closer access to table / work surfaces
- 3 Year full comprehensive warranty
- Adaptable seating - depth adjustable backrest, tilt-in-space seat, height and width adjustable quick release skirt guard / armrests and Recaro seat & powered options also available
- Width adjustable armrests. Chair grows with you and your winter clothing.
- Travel charger supplied as standard. The F55 can be used in Western Europe and UK with appropriate plug adapter



Consult with Aidacare's C.A.S.E.
(Custom And Specialised Equipment) team for this item.

Quickie P-222 Powerchair

The Quickie P-222 SE leads the pack when it comes to speed and styling. The performance is further enhanced with quality design features such as PosiDrive drive train system. These features provide the strength to maximize the chair's life and performance.

Features:

- PosiDrive Technology increases the strength of the drive train improving longevity
- 13.5 km/h top speed
- Mid-wheel drive for superior manoeuvrability (26" turning radius minimum) and curb climbing ability (for approx. 4" curbs)
- Center-of-gravity (CoG) tilt option provides tilt in a performance chair
- Optional fixed front hangers provide users with a durable, sporty look
- Detachable power base for easy access and service
- Standard 160kg. user-weight capacity



Consult with Aidacare's C.A.S.E.
(Custom And Specialised Equipment) team for this item.

Quickie Groove

Suitable for both outdoor and indoor use the modular design of the F55 lends itself well to accept a variety of seating systems and a number of powered options too

Features:

- Powerful 4-pole motors with Quickie IQ electronics help provide instant power at low speeds but control power release at high speeds to reduce over steer
- Speed up to 13.5 km/h in the RWD set-up
- 160kg (RWD) – 180kg (FWD) weight capacity
- 2-Form suspension absorbs heavy bumps in RWD and helps cushion forward pitching when braking downhill in FWD



Consult with Aidacare's C.A.S.E.
(Custom And Specialised Equipment) team for this item.

Quickie Aspire F11 or M11

Aspire provides your choice of comfort or rehab seating in a full-size (F11) or compact (M11) mid wheel drive package with a standard VSI controller.

Optional upgradeable electronics and power tilt options are available.

Rehab seat frame options accepts most modular seating systems and the High Back Comfort Seat can be ordered with a flat seat pan to accept specialised cushions.

Aspire is approved for use in vehicles and is now supplied complete with the Quickie Transit Option, including manual wheel locks.



Consult with Aidacare's C.A.S.E.
(Custom And Specialised Equipment) team for this item.



XPERIENCE

Ideal for an active end user sharing their time between indoor and outdoor activities. This Mid-Wheel Drive power wheelchair allows for easy maneuvering over day to day obstacles while offering unsurpassed stability provided by the GC3 technology. 5 years warranty on frame.

Features:

- GC3 Technology
- Short Turning Radius
- PG Drives Technology
- Fully Adjustable ASAP or Eclipse
- Seat Frame
- Low Seat to Floor Height

Weight Capacity	136 kg Standard, 181 KG Heavy Duty option
Drive Wheel	14" Cast wheel pneumatic with or without insert
Transit	4-Point wheelchair transport included
Seat to floor height	40.6 cm (16" *with 14" drive wheels)
Max Speed	10 kph
Overall Base Width	64.8 cm
Overall Base Length	110.5 cm
Colours available	4 standard colours



Gravity Control



Ground Compensation



XPLORE

Explore is an excellent choice for an active user spending time outdoors. The directional stability at high speeds in all types of environments, helps ensure that the end user's optimal Center of Gravity will be maintained without any adjustments required. 5 years warranty on frame.

Features:

- GC3 Technology
- Short Turning Radius
- PG Drives Technology
- Low Seat to Floor Height

Weight Capacity	136 kg Standard, 181 KG Heavy Duty option
Drive Wheel	35.6 cm (14" Cast wheel pneumatic with or without insert)
Transit	4-Point wheelchair transport included
Seat to floor height	40.6 cm (16")
Max Speed	13.7 kph
Overall Base Width	64.8 cm
Overall Base Length	110.5 cm
Colours available	TBA 4 standard colours

Consult with Aidacare's C.A.S.E.
(Custom And Specialised Equipment) team for this item.



Explore Tilt



Ground Compensation



XCEL

Xcel offers a standard weight capacity of 249 kg. The new Mid-wheel Heavy Duty power base features an Advance Geometric Design (A.G.D) which helps enhance the stability, mobility and comfort for the end user. As part of the Quickie X family of Canadian-made wheelchairs, the Xcel benefits through it's GC3 technology; Gravity Compensation, Ground Compensation and the Gravity Control without compromise on stability, control and freedom. 5 years warranty on frame.

Features:

- GC3 Technology
- Short Turning Radius
- PG Drives Technology
- Fully Adjustable Eclipse Seat Frame
- Low Seat to Floor Height
- Extra Duty Components

Weight Capacity	249 kg Standard
Drive Wheel	14" Cast wheel pneumatic with or without insert
Transit	4-Point wheelchair transport included
Seat to floor height	16.5" – with standard seating) 17 1/4" – with tilt
Max Speed	8.5 kph
Overall Base Width	70 cm
Overall Base Length	110.5 cm
Colours available	TBA 4 standard colours

Consult with Aidacare's C.A.S.E.
(Custom And Specialised Equipment) team for this item.



Gravity Control



Ground Compensation



OTTO BOCK - Power Wheelchair Overview

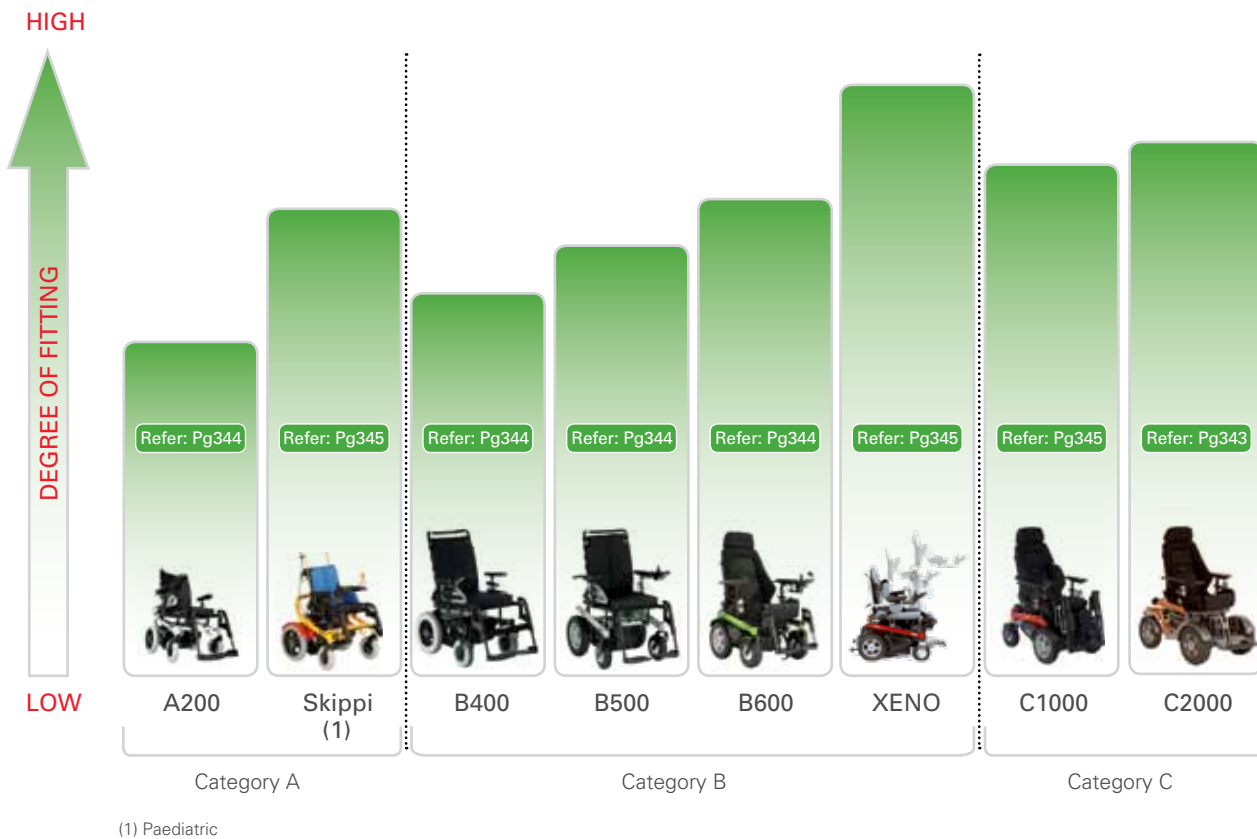

C2000

Features:

- Innovative force steering
- Seat raising of 40 cm (optional)
- Electrical tilting and back angle adjustment (optional)
- Various footplates for different areas of application/weight
- Carrier included
- Lighting included
- enAble steering, Otto Bock steering available



Max Speed	6, 10, or 15 km/h
Battery Capacity	86 Ah
Range	60 km
Electronic Control	enAble50
Load Capacity	Standard 160 (352 lbs) 200 kg (400 lbs) Special design < 260 kg
Obstacle height the wheelchair is able to overcome	150 mm
Climbing Ability	22%
Width	680 mm
Length with Footplates	122 mm
Turning Radius	940 mm





A200



Power wheelchair, can be disassembled

Standard:

- Speed of 6 km/h
- Can be disassembled
- 32 Ah gel batteries
- Distance range approx. 20 km
- Colour: silver metallic



Options:

- Control panel, swing-away in parallel
- Contoured seat
- Puncture resistant tyres
- Aluminium footplates
- Curb climbing assist
- Mechanical back angle adjustment

Consult with Aidacare's C.A.S.E. (Custom And Specialised Equipment) team for this item.

Seat Width	380 - 440 mm
Total Height	1030 mm
Seat Depth	380 - 460 mm
Length	880 mm
Back Height	550 mm
Armrest Height	240 - 360 mm
Seat Height (front/rear)	430/480 mm
Back Angle	-9 to 30°
Width	570 mm
Weight	660 mm

B400



- Mechanically elevating footrests
- Curb climbing assist
- Pelvic strap
- Lights
- Mechanical seat tilt
- Back angle adjustment
- Caster swivel lock
- Gel batteries



Consult with Aidacare's C.A.S.E. (Custom And Specialised Equipment) team for this item.

Top speed	7.2 km/h
Range	30 km
User Weight	140 kg
Own Weight	90 kg
Climbing Ability	12 %
Obstacle Height	50 mm
Width	580 mm
Length incl. Footplates	1060 mm
Turning Radius	800 mm

Seat Width	380 - 480 mm
Seat Depth	380 - 500 mm
Armrest Height	210 - 320 mm
Back Height	550 mm/400 mm/440 mm
Back Width	440 mm
Back Angle	-9° to 30°
Frame Colour	Black

B500 & B500-S



Power wheelchair for indoor and outdoor use

Standard:

- Speed of 6 km/h
- Integral control
- 60 Ah wet cell batteries
- Distance range approx. 35 km/h
- Max. load capacity of 120 kg
- Colour: ice-blue or orange
- Battery service requires no tools
- Seat cushion



Consult with Aidacare's C.A.S.E. (Custom And Specialised Equipment) team for this item.

Seat width	380 - 440 mm
Total Height	1030 mm
Seat Depth	380 - 460 mm
Length	880 mm
Back Height	550 mm
Armrest Height	240 - 360 mm
Seat Height (front/rear)	430/480 mm
Back Angle	-9 to 30°
Width	570 mm
Weight	660 mm

Options:

- Speed of 10 km/h
- Lighting
- 75 Ah, C20 gel batteries
- Suspension of all wheels
- Curb climbing assist
- Caster swivel lock
- Attendant control
- Contoured seat

B500-S Features:

- Reverse sitting to provide Front Wheel Drive

B600



Power wheelchair for indoor and outdoor use

Features

- Speed of 6 km/h
- MCS control, 2 actuator outputs and lighting
- Telescoping frame for individual adaptation
- 60 Ah wet cell batteries
- Distance range approx. 35km/h, max. load capacity of 120 kg
- Battery drawer system
- Drive wheel suspension
- Curb Climb assist



Consult with Aidacare's C.A.S.E. (Custom And Specialised Equipment) team for this item.

Seat Width	380 - 440 mm/430 - 480 mm
Total Height	1030 mm
Seat Depth	380 - 460 mm/420 - 500 mm
Length	1080 mm
Back Height	550 mm
Fixed/Variable Armrest Height	240 - 360 mm
Seat Height (front/rear)	480 mm/500 mm/550 mm/600 mm
Back Angle	-9 to 30°
Width	640 mm
Lower Leg Length	250 - 540 mm
Weight	95kg



C1000

Power wheelchair for indoor and outdoor use

Features

- Speed of 6 km/h
- MCS control and lighting
- Power-assisted steering with servotronic for indoor use
- Suspension of all wheels
- 60 Ah wet cell batteries
- Distance range approx. 35 km
- Max. load capacity of 160 kg
- Battery drawer system



Consult with Aidacare's C.A.S.E.
(Custom And Specialised Equipment)
team for this item.

Seat Width	380 - 420 mm/430 - 480 mm
Total Height	1000 mm
Seat Depth	380 - 460 mm/420 - 500 mm
Length	930 mm
Back Height	550 mm
Fixed/Variable Armrest Height	240 - 360 mm
Seat Height (front/rear)	480 mm/500 mm/550 mm/600 mm
Back Angle	-9 to 30°
Width	640 mm
Lower Leg Length	250 - 540 mm
Weight	115 kg

Xeno

Power wheelchair with stand-up function

Features

- Speed of 6 or 10 km/h
- Seat width and depth are easy to adjust; grow with the patient
- Innovative one wheel force steering, Single Servo Steering
- Biomechanical backrest, to avoid shearing forces
- Electrical seat tilt and backrest adjustment
- enAble50 driving control, for all Otto Bock special driving controls
- Angle of table top can be adjusted



Consult with Aidacare's C.A.S.E.
(Custom And Specialised Equipment)
team for this item.

Range	35 km
Load Capacity	134 kg
Overall Width	640 mm
Total length with footplate	Approximately 1220 mm
Seat Width	430/480 mm
Seat Depth	370 - 580 mm
Back Angle	20°, Electrically
Back Height	580 - 680 (incl. cushion)
Lower Leg Length	370 - 570 mm
Seat Height	530 mm (incl. cushion)
Armrest Height	180 - 250 mm

Skippi



Power wheelchair for children

Standard:

- Speed of 6km/h
- 32 Ah gel batteries
- EnAble40 control with 2 actuator outputs
- Adjustable aluminium footplate

Options:

- Seat tilt mechanism, electric or with gas compression spring
- Electric back angle adjustment
- Seating shell adapter
- Tray
- Attendant control
- Bumper bar
- Single-panel footrest with aluminium footplate
- Lighting



Consult with Aidacare's C.A.S.E.
(Custom And Specialised Equipment)
team for this item.

Maximum Speed	6 km/h
Distance range	Approx. 30 km
Max. load Capacity	50 kg
Empty Weight	570 mm
Obstacles Height	700 mm
Total width	570 mm
Total length	850 mm
Turning Radius	260 - 380 mm
Seat Height	300 - 370 mm
Seat Width	300 - 370 mm
Seat Depth	160 - 270 mm
Armrest Height	160 - 270 mm
Seat Inclination	-9 to 25°
Back Height	350 to 460 mm
Back Width	300 mm
Back Angle	0 to 25°
Lower Leg Length	110 - 260 mm
Frame Colours	Yellow, Blue, Red



Wheelchair Cushion - Overview

Foam Cushions & Supports:

Pg

L Low Risk	• General Foam Cushions & Supports	347
-------------------	--	-----

Pressure Relief Cushions:

Foam Layered:

M Medium Risk	• JAY Basic, Lite & Soft Combi	350
	• ROHO® Harmony, Mini Max, Air Lite & Mosiac.....	356
	• Pride Synergy Simplicity	361

Foam Plus Air/Gel Layered:

H High Risk	• JAY Care, Duo, Active & Easy	352
	• ROHO® Nexus Spirit & Hybrid Elite.....	357
	• Pride Synergy Solution.....	361
	• Otto Bock Advantage	362

Air/Gel Layered:

V Very High Risk	• JAY 2 Range, GS & J3 Range.....	353
	• ROHO® Quadtro Select (and others).....	358
	• Pride Synergy Spectrum.....	361
	• Otto Bock Cloud	362

Pressure Care Rating Indicator For Pressure Ulcer Risk Management

- L** Low Risk Patient
Comfort
- M** Medium Risk Patient
Prevention management
- H** High Risk Patient
Prevention and recuperation management
- V** Very High Risk Patient
Prevention and recuperation management





Multi Purpose

- Made from extremely durable and comfortable dimple foam

DVA For eligibility & prescriber info please refer to pg 7.

Code	Description	Width	Depth	RAP #:
GSS340120	Multi Purpose	450 mm	450 mm	AE05
GSS340121	Multi Purpose with Waterproof Cover	450 mm	450 mm	AE05

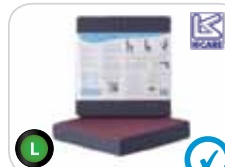

Diffuser Cushion

- Premium density pressure-relief cushion made from memory foam
- Ideal for wheelchairs or conventional seating

DVA For eligibility & prescriber info please refer to pg 7.

Code	Description	Width	Depth	RAP #:
GSS340100	Dif. Cushion	440 mm	420 mm	AE05
GSS340103	Dif. Cushion w/ Waterproof Cover	440 mm	420 mm	AE05
GSS340104	Dif. Cushion Large	490 mm	460 mm	AE05
GSS340105	Dif. Cushion L w/ W/proof Cover	490 mm	460 mm	AE05
GSS340106	Dif. Cushion Cover - W/proof long	490 mm	460 mm	AE05
GSS340101	Dif. Cushion Cover - W/proof	440 mm	420 mm	AE05

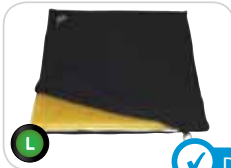

Action Gel Pad

- A universal gel pad used to elevate pressure build up and evenly distribute body weight
- The gel pad is covered in a waterproof film

DVA For eligibility & prescriber info please refer to pg 7.

Code	Description	Width	Depth	Max. User Weight	RAP #:
PTC547200	Action Gel Pad	400 mm	400 mm	Unlimited	AE05
PTC547100	Action Gel Pad	450 mm	400 mm	Unlimited	AE05
PTC547000	Action Gel Pad	450 mm	450 mm	Unlimited	AE05
PTC546990	Action Gel Pad	500 mm	500 mm	Unlimited	AE05



Cushion Posture Wedge

- Posture wedge assists with maintaining posture for persons sitting for extended periods, encourages correct pelvic tilt

DVA For eligibility & prescriber info please refer to pg 7.

Code	Description	Width	Depth	RAP #:
GSS340140	Cushion Posture Wedge	420 mm	400 mm	AE05



Relief Ring

- Relief Ring Cushion is shaped for relief of bedsores, post operative pain and other painful conditions

DVA For eligibility & prescriber info please refer to pg 7.

Code	Description	RAP #:
GSS340150	Cushion Relief Ring	AE05
GSS340151	Relief Ring Cover only	AE05



Coccyx Tailbone Cushion

- Coccyx cushion minimises painful pressure on the coccyx region
- Ergonomically designed orthopaedic cushion

DVA For eligibility & prescriber info please refer to pg 7.

Code	Description	Width	Depth	RAP #:
GSS340135	Coccyx Tailbone Cushion	420 mm	400 mm	AE05
GSS340136	Coccyx Tailbone Cushion with Waterproof Cover	420 mm	400 mm	AE05



Keyhole Cushion

- Angled seat cushion with a symmetrical aperture
- Designed and recommended for cases of post-natal or post-operative discomfort

DVA For eligibility & prescriber info please refer to pg 7.

Code	Description	Width	Depth	RAP #:
GSS340130	Keyhole Cushion	420 mm	400 mm	AE05



Diffuser Coccyx Cushion

- Coccyx cushion for relieving pressure and pain from a bruised tailbone & coccyx

DVA For eligibility & prescriber info please refer to pg 7.

Code	Description	Width	Depth	RAP #:
GSS340110	Diffuser Coccyx Cushion	440 mm	420 mm	AE05
GSS340111	Diffuser Coccyx Cushion w/ W/proof Cover	440 mm	420 mm	AE05



Cushion Ring Silicone Fibre

- Seat cushion with central cavity for pressure relief of affected areas
- Cushion is constructed of silicone coated cylindrical hollow core fibres for extra support and comfort
- Designed for post operative discomfort, haemorrhoids or prostate inflammation

DVA For eligibility & prescriber info please refer to pg 7.

Code	Description	Width	Length	Height	RAP #:
PTC542250	Cushion Ring Silicone Fibre	380 mm	420 mm	100 mm	AE05

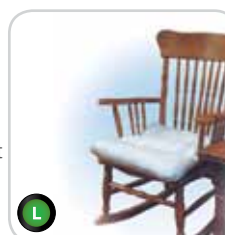

Spenco Chair Pad

- Soft chair pad helps to protect all pressure-prone areas of the body
- Manufactured from Silicore® fibres - unique hollow core, non matting shafts retain loft and allow air flow
- Breathable, cotton/polyester fabric is fully washable, dryable, and radiotranslucent

DVA For eligibility & prescriber info please refer to pg 7.

Code	Description	Width	Depth	Max User Wt.	RAP #:
PTC548800	Spenco Chair Pad	430 mm	430 mm	100 kg	AE05



Silicone Fibre Cushion

- Silicone fibre filled cushion manufactured from cylindrical hollow core fibres

DVA For eligibility & prescriber info please refer to pg 7.

Code	Description	Width	Depth	Max User Wt.	RAP #:
PTC542200	Silicone Fibre Cushion	460 mm	410 mm	100 kg	AE05
PTC542150	Silicone Fibre Cushion	410 mm	410 mm	100 kg	AE05
PTC542170	Silicone Fibre Cushion	410 mm	460 mm	100 kg	AE05
PTC542210	Silicone Fibre Cushion	510 mm	410 mm	100 kg	AE05



Back Form

- Snug support for the lower back
- Supportive flanks and tapered back corners to compensate for curved bucket-type seats
- Quality removable cover

DVA For eligibility & prescriber info please refer to pg 7.

Code	Description	RAP #:
GSS340205	Back Form	AE01



Back Support Contoured

- Full length back support ensures that entire back is supported

DVA For eligibility & prescriber info please refer to pg 7.

Code	Description	User Height	RAP #:
GSS340215	Back Support Contoured Small	122-158 cm	AE01
GSS340216	Back Support Contoured Medium	159-186 cm	AE01
GSS340217	Back Support Contoured Large	187-200 cm	AE01

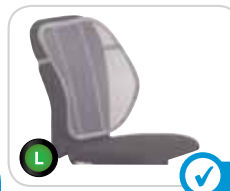

Flobac

- Back support featuring infinite adjustments to suit all comfort and support needs

DVA For eligibility & prescriber info please refer to pg 7.

Code	Description	RAP #:
GSS340230	Flobac	AE01
GSS340231	Flobac with Beaded Seat	AE01

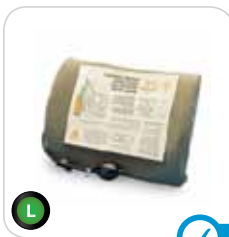

Back Support Koala Komfort

- Has an adjustable lumbar zone to adapt to user's comfort
- Koala Komfort features a rubber bladder enclosed inside the moulded back support

DVA For eligibility & prescriber info please refer to pg 7.

Code	Description	RAP #:
GSS340210	Back Support Koala Komfort	AE01



Back Huggar

- Contoured to provide support and help alleviate lower back fatigue
- Removable insert to reduce depth or modify lumbar curve

DVA For eligibility & prescriber info please refer to pg 7.

Code	Description	RAP #:
GSS340200	Back Huggar	AE01
GSS340201	Back Huggar with Memory Foam	AE01



Total Spinal Support

- Full moulded back support has unique flanking support designed to prevent lateral movement
- Flanking support relieves stress on major structure of lumbar spine and rib cage

DVA For eligibility & prescriber info please refer to pg 7.

Code	Description	RAP #:
GSS340220	Total Spinal Support Tall (Car/Office/Chair)	AE01
GSS340221	Total Spinal Support Medium (Couch/Home)	AE01

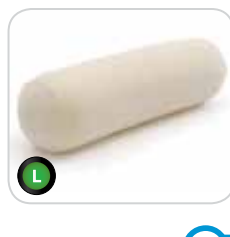

Latex Multi-Use Roll

- Constructed of natural latex for maintenance of shape.
- Ideal for use under ankles or between knees

DVA For eligibility & prescriber info please refer to pg 7.

Code	Description	RAP #:
GSS340250	Latex Multi-Use Roll with Poly Cover	AE01
GSS340251	Waterproof Replacement Cover	AE01



Lumbar Roll

- Lumbar Roll is a simple, effective product designed to discourage slouching

DVA For eligibility & prescriber info please refer to pg 7.

Code	Description	RAP #:
GSS340240	Lumbar Roll D Shape	AE01
GSS340241	Lumbar Roll D Shape Memory Foam	AE01
GSS340248	Lumbar Roll Demi D Shape (Small D Shape)	AE01
GSS340242	Lumbar Roll Oval Shape	AE01
GSS340244	Lumbar Roll Round Shape	AE01
GSS340246	Lumbar Roll Egg Shape	AE01



Quad Cushion

- The Quad Cushion provides comfort and support for the lower back, under knees and under ankles by relieving pressure.

DVA For eligibility & prescriber info please refer to pg 7.

Code	Description	Length	Width	Height	RAP #:
BEP056220	Quad Cushion	530 mm	260 mm	90 mm	AE02
BEP056221	Quad Cushion Replacement Slip Only				AE02



Universal Cushion

- The Askle Universal Cushion is an adaptable cushion for all care situations
- Promust fabric is water proof and vapor permeable for comfort and cleaning

DVA For eligibility & prescriber info please refer to pg 7.

Code	Description	Dimensions	Product Weight	RAP #:
PTA507443	Universal Cushion Small	410 x 310 mm	0.23 kg	AE05
PTA507444	Universal Cushion Medium	640 x 440 mm	0.58 kg	AE05



Lateral Positioning Cushion

- Reducing pressure on trochanter the lateral positioning cushion promotes a 30 degree side lying position which is the recommended position in order to minimise pressure
- The advantage of this cushion is its one piece design to support head, trunk, legs and feet

Code	Description	Patient Height	Dimensions	Product Weight
PTA507439	Lateral Positioning Cushion regular	< 165 cm	1830 x 666 mm	2.0 kg
PTA507440	Lateral Positioning Cushion large	> 165 cm	1940 x 666 mm	2.2 kg



Half Moon Cushion

- The Half Moon Cushion is designed to be used in the semiseated position to support the trunk
- The Promust fabric is water proof and vapor permeable for comfort and cleaning
- Stitched with antibacterial thread

Code	Description	Dimensions	Product Weight
PTA507441	Half Moon Cushion	1590 x 790 mm	1.9 kg



Hip Abduction Cushion

- The Hip Abduction Cushion is recommended for use after a hip replacement to reduce the risk of hip dislocation by holding the hips in an abducted position
- The Promust fabric is water proof and vapor permeable for comfort and cleaning.
- Stitched with antibacterial thread.

Code	Description	Dimensions	Product Weight
PTA507442	Hip Abduction Cushion	342 x 300 mm	0.43 kg



Circular Cushion

- The Askle Circular Cushion is designed to be used around the head and neck providing comfort and support
- Promust fabric is water proof and vapor permeable for comfort and cleaning
- Stitched with antibacterial thread

Code	Description	Dimensions
PTA507449	Circular Cushion	460 x 460 mm



Cylindrical Cushion

- The Askle Cylindrical Cushion helps with flexing of the knees reducing pressure on the back and relieving facet pain
- Promust fabric is water proof and vapor permeable for comfort and cleaning
- Stitched with antibacterial thread

Code	Description	Dimensions	Product Weight
PTA507445	Cylindrical Cushion	210 x 60 mm	0.64 kg



Knee Abduction Cushion

- The Askle Knee Abduction Cushion helps maintain abduction in the lower legs protecting the knee joints
- Promust fabric is water proof and vapor permeable for comfort and cleaning
- Stitched with antibacterial thread

Code	Description	Dimensions	Product Weight
PTA507446	Knee Abduction Cushion	680 x 515 mm	0.36 kg



Heel Pad Cushion

- The Askle Heel Pad Cushion supports the lower leg and reduces pressure on the heel by placing the heel in the dorsal decubitus position
- Helps improve blood flow and has smooth edges to prevent any localised pressure points

Code	Description	Dimensions	Product Weight
PTA507447	Heel Pad Cushion	412 x 228 mm	0.23 kg



Elbow Pad Cushion

- The Askle Elbow Pad Cushion provides support to the lower arm and reduces pressure on the elbow
- Helps improve blood flow and has smooth edges to prevent any localised pressure points
- Promust fabric is water proof and vapor permeable for comfort and cleaning

Code	Description	Dimensions	Product Weight
PTA507448	Elbow Pad Cushion	412 x 228 mm	0.23 kg

Low Risk Medium Risk High Risk Very High Risk



Sunrise Medical - Jay Cushions Overview

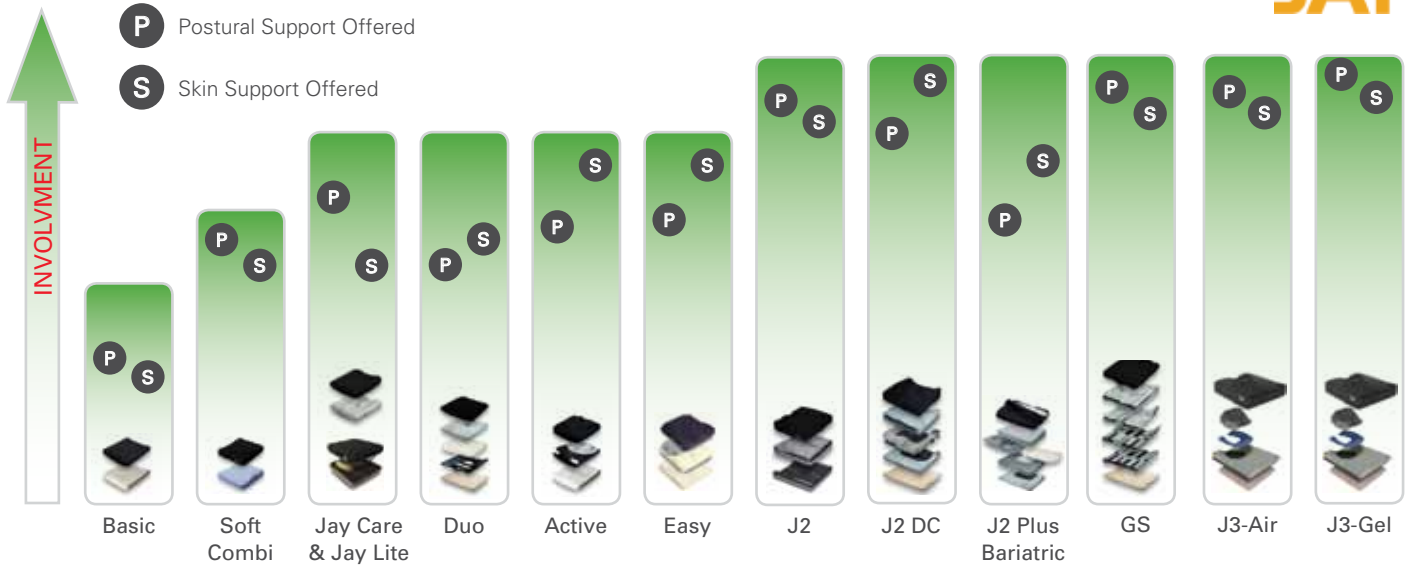

SPECIFIC APPLICATIONS: JAY DUO - Ideal for foot propulsion ; JAY CARE - Can accommodate a fixed posterior pelvic tilt ; J2 PLUS - 295 kg. Weight capacity



JAY - Basic

- Designed for the client who has symmetrical postures needing minimal postural support
- Durable pre-contoured foam provides lateral stability; encourages orthopaedic alignment; and helps redistribute pressure to increase sitting tolerance
- Most suitable for clients with low risk of skin breakdown

✓ DVA CONTRACTED
 AE05.....BUY
 Prescribers... OT/Phys/Ch/Ost/RN/S/LMO
 For approval rules refer to pg 7.

Aidacare Code	Supplier Code	Chair Size (w x d)	Height (inches)	Max User Wt.	RAP #:
PTC567600	J308	14 x 16"	2.5"	113 kg	AE05
PTC567400	J305	16 x 16"	2.5"	113 kg	AE05
PTC567500	J306	16 x 18"	2.5"	113 kg	AE05
PTC566900	J301	18 x 18"	2.5"	113 kg	AE05
PTC567700	J309	20 x 18"	2.5"	113 kg	AE05
PTC567750	J328	22 x 18"	2.5"	136 kg	AE05
PTC566950	J320	22 x 20"	2.5"	136 kg	AE05

- All models include**
- Incontinence resistance cover
 - 12mth Warranty (6mths on cover)

Note (1) For sizes outside of the codes displayed, please contact your Aidacare C.A.S.E. consultant.



JAY - Lite

- An ideal off-the-shelf complement to ultra lightweight wheelchairs
- Constructed with lightweight 3DX Microclimatic spacer fabric and Airflow base provide excellent microclimatic heat and moisture dissipation
- The OptiWell pelvic loading area help achieve high levels of pressure distribution and stability in an extremely lightweight cushion
- Available with positioning inserts for those with postural needs (please ask our Aidacare C.A.S.E consultants for help selecting these. Refer: C.A.S.E section pg 13)
- Available in sizes 14x14" to 24x24". Common sizes are shown below

✓ DVA CONTRACTED
 AE05.....BUY
 Prescribers... OT/Phys/Ch/Ost/RN/S/LMO
 For approval rules refer to pg 7.

- All models include**
- Micro-climatic cover
 - 12mth Warranty (6mths on cover)

Note (1) For sizes outside of the codes displayed, please contact your Aidacare C.A.S.E. consultant.

Aidacare Code	Supplier Code	Chair Size (width x depth)	Height (inches)	Max User Wt.	RAP #:	Aidacare Code	Supplier Code	Chair Size (width x depth)	Height (inches)	Max User Wt.	RAP #:
PTC571902	JL1414	14 x 14"	3.4"	110 kg	AE05	PTC571913	JL1618	16 x 18"	3.4"	113 kg	AE05
PTC571901	JL1416	14 x 16"	3.4"	110 kg	AE05	PTC585155	JL1818	18 x 18"	3.4"	113 kg	AE05
PTC571970	JL1516	15 x 16"	3.4"	110 kg	AE05	PTC571925	JL2018	20 x 18"	3.4"	113 kg	AE05
PTC571911	JL1616	16 x 16"	3.4"	110 kg	AE05	PTC571950	JL2018	22 x 18"	3.4"	113 kg	AE05

L Low Risk **M** Medium Risk **H** High Risk **V** Very High Risk



JAY

JAY - SOFT COMBI

- Designed for the client who has symmetrical postures needing minimal to moderate postural support
- Pre-contoured foam base features a deeper leg trough and increased medial thigh support
- Provides mild lateral stability as well as mild to moderate forward/rearward stability
- Provides trochanteric support to distribute pressure away from the ischials
- Most suitable for clients with low risk of skin breakdown

✓ DVA CONTRACTED
 AE05..... BUY
 Prescribers... OT/Phys/Ch/Ost/RN/S/LMO
 For approval rules refer to pg 7.

Soft Combi (JB)

- Softer foam
- Higher pressure disbursement

With Lumber Support

- Optional extra or as a kit

All models include

- Incontinence cover
- 5 Year Warranty (unparalleled)

Soft Combi					
Aidacare Code	Supplier Code	Chair Size (width x depth)	Height (inches)	Max User Wt.	RAP #:
(1)	JB2200	18 x 16"	3"	113 kg	AE05
PTC572700	JB2201	18 x 18"	3"	113 kg	AE05
PTC572800	JB2202	20 x 18"	3"	113 kg	AE05
PTC572900	JB2203	18 x 20"	3"	113 kg	AE05
PTC573000	JB2205	16 x 16"	3"	113 kg	AE05
PTC573100	JB2206	16 x 18"	3"	113 kg	AE05
PTC573200	JB2207	16 x 20"	3"	113 kg	AE05
PTC573300	JB2210	14 x 14"	3"	113 kg	AE05
PTC573400	JB2215	12 x 12"	4"	113 kg	AE05
(1)	JB2220	22 x 20"	3"	136 kg	AE05
(1)	JB2228	22 x 18"	3"	136 kg	AE05

Note (1) Please contact Aidacare C.A.S.E. consultant for sizes outside of the displayed range.



JAY

JAY - CARE

- Most suitable for the sacral sitter, the JAY CARE is designed for the client who has symmetrical posture needing moderate postural support
- The pre-contoured foam base provides a longer seat well to accommodate fixed "sacral sitting" where the ischials are positioned forward. Contours also provide moderate lateral and forward/rearward stability
- The reinforced curved bottom counteracts the negative effects associated with sling upholstery providing a level sitting surface
- The fluid-filled 'Tripad' incorporates left/right/rear sections to maintain the fluid under at-risk bony areas
- Most suitable for the client at moderate risk of skin breakdown where independent weight shift is possible

✓ DVA CONTRACTED
 AE04..... BUY
 Prescribers... OT/Phys/RN/Ch/Ost/S/LMO
 For approval rules refer to pg 7.

Consult with Aidacare's C.A.S.E.
 (Custom And Specialised Equipment) team for this item.

All models include

- Two washable stretch covers
- Incontinence resist inner casing
- 24mth Warranty (6mths on cover)

- 1 JAY fluid 'Tripad' over foam base
- 2 Washable stretch cover

Aidacare Code	Supplier Code	Chair Size (width x depth)	Height (inches)	Max User Weight	RAP #:
PTC567800	J3100B	18 x 17.5"	3.5"	113 kg	AE04
PTC567900	J3101B	18 x 19.5"	3.5"	113 kg	AE04
PTC568000	J3105B	16 x 17.5"	4.0"	113 kg	AE04
PTC568100	J3106B	16 x 19.5"	4.0"	113 kg	AE04
PTC568200	J3109B	20 x 19.5"	3.5"	113 kg	AE04

Note (1) Please contact Aidacare C.A.S.E. consultant for sizes outside of the displayed range.

L Low Risk **M** Medium Risk **H** High Risk **V** Very High Risk



- 1 Lightweight Aluminium Base
- 2 Soft foam pre-contoured cushion
- 3 'Jay Flow' fluid pad
- 4 2-way stretch washable cover

JAY - DUO

- Designed for the client who has symmetrical postures needing mild to moderate physical support.
- The lightweight aluminium pre-contoured solid base attaches to chair rails effectively replacing the sling seat upholstery.
- The aluminium base in combination with a soft foam & fluid cushion provides an anatomically correct, stable base of support that promotes postural stability.
- The pre-contoured foam base of the JAY DUO provides mild lateral and forward/rearward stability and provides a base of support that promotes foot propelling or independent transfers.
- The 'Jay Flow' fluid pad reduces the effects of shearing on the ischial tuberosities.
- Most suitable for the client at moderate risk of skin breakdown who can ideally perform independent weight-shift.
- Includes two washable stretch covers. 24mth Warranty on cushion (6mths on cover).

✓ DVA CONTRACTED
 AE04..... BUY
 Prescribers... OT/Phys/RN/Ch/Ost/S/LMO
 For approval rules refer to pg 7.

Consult with Aidacare's C.A.S.E.
 (Custom And Specialised Equipment)
 team for this item.

Aidacare Code	Supplier Code	Chair Size (width x depth)	Height (inches)	Max Use Weight	RAP #:
PTC569000	J700	18 x 16"	3"	110 kg	AE04
PTC569100	J701	18 x 18"	3.5"	110 kg	AE04
PTC569200	J705	16 x 16"	4"	110 kg	AE04
PTC569300	J706	16 x 18"	3"	110 kg	AE04
PTC569400	J709	20 x 18"	3"	110 kg	AE04
(1)	J776	17 x 16"	3"	110 kg	AE04
PTC569500	J778	17 x 18"	3"	110 kg	AE04
(1)	J726	20 x 16"	3"	110 kg	AE04

Note (1) Please contact Aidacare C.A.S.E. consultant for sizes outside of the displayed range.



- 1 Soft foam pre-contoured base
- 2 'Jay Flow' and abductor inserts
- 3 JAY AirExchange cover

JAY - ACTIVE

- The JAY ACTIVE cushion is lightweight and designed for the active client who requires mild to moderate positioning and moderate to high skin protection.
- The pre-contoured foam base provides stable support for the pelvis. Lateral abductor inserts provide optional thigh support.
- The Jay Flow fluid segmented pad design enhances postural stability whilst moving with the active client to reduce the effects of shear
- Jay Flow fluid conforms to bony prominences, distributing pressure more evenly to reduce peak pressure points

Consult with Aidacare's C.A.S.E.
 (Custom And Specialised Equipment)
 team for this item.

All models include

- JAY 'AirExchange' cover.
- 24mth Warranty (6mths on cover)

Supplier Code	Chair Size (width x depth)	Height (inches)	Max User Weight
J120	18 x 16"	3"	110 kg
J121	18 x 18"	3"	110 kg
J122	20 x 18"	3"	110 kg
J123	18 x 20"	3"	110 kg
J125	16 x 16"	3"	110 kg
J126	16 x 18"	3"	110 kg
J127	16 x 20"	3"	110 kg
J128	14 x 16"	3"	110 kg

Note: Please consult with your Aidacare C.A.S.E team member for inquiries relating to the JAY-ACTIVE lateral abductor inserts. (Refer: C.A.S.E overview on pg 13)

L Low Risk **M** Medium Risk **H** High Risk **V** Very High Risk



JAY

JAY - EASY

- The Jay Easy is an economical cushion with design characteristics from the Jay Xtreme and Jay Care cushions
- Developed for individuals who require moderate positioning and pressure relief, the JAY Easy can be used with either a seat sling or a solid base
- The pre-contoured foam base features significant lateral and medial thigh contours for clients who require greater positioning
- Optional Curved base (for use on a seat sling) or a Flat base (for use on a solid seat pan or in combination with a solid insert)
- The rear of the cushion base features a sacral notch similar to the one in the Jay Xtreme base. This notch prevents tissue breakdown around the coccyx caused by bouncing or posterior pelvic tilt
- The Jay Flow Fluid Tripad provides pressure relief and shear reduction for users who are at moderate risk for skin breakdown

✓ DVA CONTRACTED
 AE04..... BUY
 Prescribers... OT/Phys/RN/Ch/Ost/S/LMO
 For approval rules refer to pg 7.

Consult with Aidacare's C.A.S.E.
 (Custom And Specialised Equipment) team for this item.

All models include

- 2 way stretch cover
- 24mth Warranty (6mths on cover)

- 1 Soft foam pre-contoured base
- 2 'Jay Flow' fluid Tripad
- 3 JAY AirExchange cover

Aidacare Code	Supplier Code	Chair Size (width x depth)	Height (inches)	Pelvic Contour Width	Max User Wt.	RAP #:
PTC580004	J1416C	14 x 16" (curved)	3.5"	12.50"	110 kg	AE04
PTC580005	J1416F	14 x 16" (flat)	3.5"	12.50"	110 kg	AE04
PTC580100	J1515F	15 x 15" (flat)	3.5"	12.50"	110 kg	AE04
PTC580200	J1616C	16 x 16" (curved)	3.5"	14.00"	110 kg	AE04
PTC580300	J1616F	16 x 16" (flat)	3.5"	14.00"	110 kg	AE04
PTC580400	J1618C	16 x 18" (curved)	3.5"	14.00"	110 kg	AE04
PTC580350	J1717F	17 x 17" (flat)	3.5"	14.00"	110 kg	AE04
PTC580500	J1816C	18 x 16" (curved)	3.5"	14.00"	110 kg	AE04
PTC580600	J1818C	18 x 18" (curved)	3.5"	14.00"	110 kg	AE04

Note: JAY EASY cushions are available in a wide range of sizes from 14x16" to 20x20". Only the more common sizes are shown in the table. Please consult with your Aidacare C.A.S.E consultant for sizing guidance. (Refer: C.A.S.E overview pg 13)



JAY

JAY - J2

- Designed for the client who has moderate to more aggressive postural needs that may change over time
- The J2 pre-contoured, closed-cell, lightweight, foam base provides excellent lateral and forward/rearward stability creating a foundation for postural stability
- Designed for the client with moderate to aggressive postural needs that may change over time
- The J2 pre-contoured, closed-cell, lightweight, foam base provides excellent lateral and forward/rearward stability creating a foundation for postural stability
- The base fluid pad can be modified/customised on site to accommodate fixed postures or to correct flexible postures. Modifications can support changing needs over time
- Optional solid seat inserts provide extra postural stability discouraging the cushion from slinging with the chair upholstery
- Postural accessories such as medial and lateral thigh supports, lateral pelvic supports and pelvic obliquity supports can be added to the cushion

✓ DVA CONTRACTED
 AE04..... BUY (PA Rqd)
 Prescribers... OT/Phys/RN/Ch/Ost/S/LMO
 For approval rules refer to pg 7.

Consult with Aidacare's C.A.S.E.
 (Custom And Specialised Equipment) team for this item.

- The 'Jay Flow' fluid Tripad conforms to bony prominences, distributes pressure more evenly and reduces peak pressures. The Tripad design assists in maintaining fluid under the at-risk bony areas
- Most suitable for the client who is at higher risk of skin breakdown and who has poor skin integrity
- Optional Balistic Stretch; AirExchange or Incontinence cover.
- 24mths Warranty (6mths on cover)

- 1 Closed-cell ultra-lightweight base
- 2 'Jay Flow' fluid Tripad
- 3 JAY AirExchange or Incontinence cover (optional)

Aidacare Code	Supplier Code	Chair Size (width x depth)	Height (inches)	Max User Wt.	RAP #:
PTC562500	J2105	16 x 16"	3"	114kg	AE04
PTC562700	J2106	16 x 18"	3"	114kg	AE04
PTC563800	J2117	17 x 17"	3"	114kg	AE04
PTC561100	J2100	18 x 16"	3"	114kg	AE04
PTC561300	J2101	18 x 18"	3"	114kg	AE04
PTC562100	J2103	18 x 20"	3"	114kg	AE04
PTC563700	J2116	20 x 16"	3"	114kg	AE04
PTC564100	J2118	20 x 18"	3"	114kg	AE04

Note: The table shows the common sizes only. The Jay-J2 series of cushions are customisable to suit the specific needs of your client. Please consult with your Aidacare C.A.S.E team member for inquiries relating to customisations for your client. (Refer: C.A.S.E overview on pg 13)

- L Low Risk
- M Medium Risk
- H High Risk
- V Very High Risk

Ask your Aidacare C.A.S.E. consultant about the J2 Recline option for reclining wheelchairs.



JAY

JAY - J2 Deep Contour (DC)

- The J2-DC takes the J2 to a higher level of pressure and postural management
- Cushion depth is increased in the DC from 3" to 4"
- Pelvic contour depth increases from 2.5" to 3"
- An optional solid drop-seat (shown - bottom) can be permanently attached to promote a level platform
- '3D Jay Flow' fluid Tripad provides 3" deep-immersion pressure and postural management
- The J2 DC is most suitable for the client who is at the highest level of risk for skin breakdown or who has very poor skin integrity
- Optional Balistic Stretch; AirExchange or Incontinence cover. 24mths Warranty on Cushion (6mths on cover)

- 1 Solid seat insert (optional)
- 2 Closed-cell ultra-lightweight base
- 3 Leg Trough modification for hip ROM.
- 4 '3D Jay Flow' fluid Tripad
- 5 JAY AirExchange or Incontinence covers

✓ DVA CONTRACTED
 AE04.....BUY (P.A Rqd)
 Prescribers... OT/Phys/RN/Ch/Ost/S/LMO
 For approval rules refer to pg 7.

Consult with Aidacare's C.A.S.E.
 (Custom And Specialised Equipment)
 team for this item.

Aidacare Code	Supplier Code	Chair Size (width x depth)	Height (inches)	Max User W.t	✓ RAP #:
PTC566000	J2466	16 x 16"	4"	114 kg	AE04
PTC566100	J2468	16 x 18"	4"	114 kg	AE04
PTC566400	J2477	17 x 17"	4"	114 kg	AE04
PTC566600	J2486	18 x 16"	4"	114 kg	AE04
PTC566700	J2488	18 x 18"	4"	114 kg	AE04
PTC566500	J2480	18 x 20"	4"	114 kg	AE04
PTC565150	J2406	20 x 16"	4"	114 kg	AE04
PTC565000	J2408	20 x 18"	4"	114 kg	AE04

Note: The table shows the common sizes only. The Jay-J2 Deep Contour cushions are customisable to suit the specific needs of your client. Please consult with your Aidacare C.A.S.E team member for inquiries relating to customisations for your client. (Refer: C.A.S.E overview on pg 13)



JAY

JAY - J2 Plus (Bariatric)

- The Jay J2 Plus Cushion offers the bariatric client all the clinical benefits of the Jay J2 Cushion with a weight capacity of 295 kg
- Multiple insert selections: Allow therapists to customize the Jay J2 Plus Cushion. For patients who are at low risk for skin breakdown, both standard and custom foam packages are available. These packages feature layers of Visco foam that stack into the seat-well. For patients at high risk, fluid pad inserts are available
- Cover Choices: Tritex air-exchange cover which promotes cool-air movement, and an incontinent-resistant low-shear cover that combines the benefits of incontinent resistance and low shear
- Urethane overlay cover: Protection from incontinence is an important feature in a bariatric cushion. The Jay J2 Plus Cushion offers a removable urethane overlay cover to further protect the cushion
- Anterior tilted base: Most bariatric patients have a problem with slumping forward. This is caused by the downward pull of their stomachs. By providing a slight anterior tilt to the cushion base, the hip angle is opened up enabling patients to sit more upright

- 1 Closed-cell foam base with anterior tilt
- 2 13" Seat Well structure
- 3 Optional: Seat well inserts (gel or foam)
- 4 Urethane overlay cover
- 5 JAY Tritex AirExchange or Incontinence cover (optional)

✓ DVA CONTRACTED
 AE04.....BUY (P.A Rqd)
 Prescribers... OT/Phys/RN/Ch/Ost/S/LMO
 For approval rules refer to pg 7.

All models include

- Optional incontinence cover or Air Exchange cover
- 24mth Warranty (6mths on cover)

Consult with Aidacare's C.A.S.E.
 (Custom And Specialised Equipment)
 team for this item.

Aidacare Code	Supplier Code	Chair Size (width x depth)	Height (inches)	Max User W.t	✓ RAP #:
PTC567000	J302018	20 x 18"	4.5"	295 kg	AE04
(1)	J302020	20 x 20"	4.5"	295 kg	AE04
(1)	J302022	20 x 22"	4.5"	295 kg	AE04
PTC567100	J302218	22 x 18"	4.5"	295 kg	AE04
PTC567200	J302220	22 x 20"	4.5"	295 kg	AE04
PTC567250	J302222	22 x 22"	4.5"	295 kg	AE04
PTC567300	J302418	24 x 18"	4.5"	295 kg	AE04

Note: The table shows the common sizes only. The Jay-J2 Deep Contour cushions are customisable to suit the specific needs of your client. Please consult with your Aidacare C.A.S.E team member for inquiries relating to customisations for your client. (Refer: C.A.S.E overview on pg 13)





JAY

- 1 Solid seat insert (optional)
- 2 Polyethylene foam base with "anti-thrust"
- 3 Optional: Seat well reducers & abductor
- 4 'Jay Flow' fluid pad w/ abductor option.
- 5 JAY Incontinence cover or AirExchange (optional)
- 6 'Jay Flow' fluid pad w/o abductor option

JAY - GS (paediatric)

- The Jay GS utilizes technology developed for the Jay J2 cushion and adapts it to the specific needs of children.
- The Jay GS design incorporates the technologies of the 'Jay Flow' fluid, and includes growth capabilities to allow the cushion to grow with the child.
- This is the ideal cushion for the paediatric or adult client with high positioning needs who is a moderate to high risk for skin breakdown.
- The foam base is pre-contoured with an "anti-thrust" shelf to keep the pelvis from sliding forward. The longer seat well can be used to accommodate the fixed posterior pelvic tilt of sacral sitters
- Optional anterior seat well reducers can be added to maintain the seat well length when the seat depth is increased.
- A variety of optional supports can position and maintain optimal pelvic and lower extremity posture
- Standard fluid pad provides shear reduction and improved pressure distribution for users at moderate risk

Consult with Aidacare's C.A.S.E.
(Custom And Specialised Equipment)
team for this item.

All models include

- Incontinence cover
- Optional: Air Exchange cover
- 24mth Warranty (6mths on cover)

Aidacare Code	Supplier Code	Chair Size (width x depth)	Height (inches)	Max User Weight
PTC558300	J1100N	18 x 20"	3"	113 kg
PTC558500	J1105N	16 x 19"	3"	113 kg
PTC558700	J1110N	14 x 17"	3"	113 kg
PTC559000	J1115N	12 x 15"	3"	113 kg
PTC558800	J1111N	10 x 13"	3"	113 kg

Note: The JAY - GS series offers a wide range of optional cushion inserts specific to the needs of your client. Please consult with your Aidacare C.A.S.E team member for the range of options available and sizing. (Refer: C.A.S.E overview on pg 13)



JAY

- 1 Solid seat insert (optional)
- 2 Closed-cell ultra-lightweight base
- 3 3 x PLA Size variations
- 4 4 x PLA insert variations. Jay Flow factory shown. Optional ROHO DRY FLOATATION® inserts
- 5 3 x Cover Options - all black

JAY - J3 Gel or J3 Air w/ ROHO®

The Jay-J3 series of cushions are highly customisable to suit your client's needs.

Customisations cover 6 spectrums: (1) Cushion height; (2) Cushion width & depth; (3) PLA size (Pelvic Loading Area); (4) PLA insert choice (4 options); (5) Cover Options (3 options); (6) Positioning components.

We strongly recommend that you consult with your Aidacare C.A.S.E team member for any inquiries relating to these cushions. Refer: C.A.S.E overview on pg 13)

- The J3 features two models (1) the Gel and (2) the Air (with ROHO DRY FLOATATION® insert (see below for more detail)
- The J3 range features outstanding pressure distribution, comfort, heat/moisture dissipation, and optimal stability
- With 230kg weight capacity the J3 is also a bariatric option.
- Pelvic loading area (PLA): Optimally shaped and sized to evenly distribute pressure under the pelvis. Available in 3 sizes, the PLA can be selected and sized to fit the user's pelvis regardless of the overall cushion width
- The PLA insert is available in four options: (1) Factory Filled JAY Flow™ fluid; (2) Field Variable JAY Flow fluid; (3) Air Single ROHO DRY FLOATATION® Technology; and, (4) Air Dual ROHO DRY FLOATATION® Technology. These four inserts provide two important benefits: hydrostatic loading (even distribution of load) and adjustability (in-field adjustment or custom factory adjustment) to ensure the best possible immersion, pressure distribution, and stability
- The J3 cushion features three cover options: (1) Stretch; (2) Microclimatic; or (3) Incontinent-resistant. All 3 covers are designed to minimise shear risks; provide comfort; and wick away heat and moisture
- The J3 is available with a wide range of positioning options to help the user maintain appropriate postural stability. Optional lateral and medial thigh supports as well as lateral pelvic supports are affixed securely to the cushion base

DVA CONTRACTED
AE04..... BUY (P.A Rqrd)
Prescribers... OT/Phys/RN/Ch/Ost/S/LMO
For approval rules refer to pg 7.

Consult with Aidacare's C.A.S.E.
(Custom And Specialised Equipment)
team for this item.

- L** Low Risk
- M** Medium Risk
- H** High Risk
- V** Very High Risk

DVA Contact Details
P 1300 888 052
F 1300 787 052
E dva@aidacare.com.au

General Enquiries
P 1300 133 120
E admin@aidacare.com.au
W www.aidacare.com.au





ROHO® - Mosaic

- Designed to provide a comfortable, functional and stable sitting environment for patients who are at risk of skin breakdown
- The Mosaic is also a Dry Floatation cushion but is made from softer plastic than the classic ROHO DF cushions. It is therefore lighter (0.5kg) but less rugged
- Interconnected air cells disperse pressure and promote stability as the pelvis sinks into them
- The Mosaic is also excellent as a lounge-chair cushion or even as a shower cushion too

✓ DVA CONTRACTED (all codes)
 AE05..... BUY
 Prescribers... OT/Phys/Ch/Ost/RN/S/LMO
 For approval rules refer to pg 7.

All models include

- 2 way stretch cover
- Hand Pump & Repair Kit
- Operating Instructions
- 24 Month Warranty

WIDTH (Size")	DEPTH (Size")	
	18"	16"
18"	PTC586300	PTC586200
16"	(1)	PTC586100

Note (1) Please contact Aidacare for inquiries relating to sizes outside of the displayed range.



ROHO® - Air Life

- Designed for clients with tactile sensation who are at low risk of developing skin breakdown
- Contoured foam base with an internal sealed air cell provides comfort and support for basic positioning and pressure management needs

✓ DVA CONTRACTED (all codes)
 AE05..... BUY
 Prescribers... OT/Phys/Ch/Ost/RN/S/LMO
 For approval rules refer to pg 7.

All models include

- 2 way stretch cover
- Hand Pump & Repair Kit
- Operating Instructions
- 24 Month Warranty

WIDTH (Size")	DEPTH (Size")		
	18"	17"	16"
20"	PTC551450	(1)	(1)
18"	PTC551400	(1)	(1)
17"	(1)	PTC602200	(1)
16"	PTC551300	(1)	PTC602100

Note (1) This range can fit chairs from 14x14" (35x35cm) to 20x18" (51x46cm). Please contact Aidacare for inquiries relating to sizes outside of the displayed range.

Sizes listed are seat dimensions. The actual cushion is 1.5" longer to allow for the cushion to sit between the back canes.



ROHO® - Contour Base

- Designed to provide a solid foundation to sling-seat wheelchairs
- Easily fits under the cushion inside the ROHO cushion-cover
- Made from moulded lightweight plastic (0.7kg) the base promotes postural integrity by improving symmetrical seating, preventing rotation of the femurs and providing forward pelvic stability

WIDTH (Size")	DEPTH (Size")				
	20"	18"	17"	16"	15"
20"	PTC541510	(1)	PTC541505	(1)	(1)
18"	PTC541500	PTC541500	(1)	PTC541400	(1)
17"	(1)	(1)	PTC541300	(1)	(1)
15"	(1)	(1)	(1)	(1)	PTC541200

Note (1) Please contact Aidacare for inquiries relating to sizes outside of the displayed range.

L Low Risk **M** Medium Risk **H** High Risk **V** Very High Risk



ROHO® - Mini Max

- Designed for short-term needs of users with high comfort needs but at low-level risk of skin breakdown
- Inter-connected air cells provide shock absorption and pressure reduction
- Lightweight: At 0.9kg the Mini Max cushion adds minimal weight to the entire mobility solution
- Great for travel and sports

DVA CONTRACTED

AE05..... BUY

Prescribers... OT/Phys/Ch/Ost/RN/S/LMO

For approval rules refer to pg 7.

WIDTH (Size")	DEPTH (Size")		
	18"	16"	15"
18"	PTC555000	PTC554900	(1)
16"	(1)	(1)	(1)
15"	PTC555000	PTC554900	(1)

Note (1) This range can fit chairs from 14x16" (35x40cm) to 20x18" (51x46cm). Please contact Aidacare for inquiries relating to sizes outside of the displayed range. Sizes listed are seat dimensions. The actual cushion is 1.5" longer to allow for the cushion to sit between the back canes.

All models include

- 2 way stretch cover
- Hand Pump & Repair Kit
- Operating Instructions
- 12 Month Warranty



ROHO® - Harmony

- Stability: The Harmony cushion is built on an anatomically-shaped foam base that enhances stability for the user
- Pressure: A ROHO Air Floatation cushion on top of the foam base provides comfort and pressure support for longer sitting times
- Lightweight: At 0.7kg the Harmony cushion adds minimal weight to the entire mobility solution
- Moisture resistant cover protects the foam insert
- Appropriate for clients with moderate to low risk of skin breakdown who require a lightweight solution and that provides stability

DVA CONTRACTED (all codes)

AE04..... BUY

Prescribers... OT/Phys/RN/Ch/Ost/S/LMO

For approval rules refer to pg 7.

WIDTH (Size")	DEPTH (Size")				
	18"	17"	16"	15"	14"
20"	PTC555100	(1)	(1)	(1)	(1)
18"	PTC555000	(1)	PTC554900	(1)	(1)
17"	PTC554800	(1)	PTC554700	(1)	(1)
16"	PTC554600	(1)	PTC554500	(1)	(1)
15"	(1)	(1)	(1)	(1)	(1)
14"	(1)	(1)	PTC554400	(1)	(1)

All models include

- 2 way stretch cover
- Hand Pump & Repair Kit
- Operating Instructions
- 12 Month Warranty

Note (1) This range can fit chairs from 14x16" (35x40cm) to 20x18" (51x46cm). Please contact Aidacare for inquiries relating to sizes outside of the displayed range.

Sizes listed are seat dimensions. The actual cushion is 1.5" longer to allow for the cushion to sit between the back canes.



ROHO® - Nexus Spirit

- Stability: The Nexus Spirit combines the stability of a contoured foam base with a ROHO Dry Floatation cushion for therapeutic care
- Posture: The contoured foam base provides increased stability for transfers and also provides excellent pelvic positioning for improved posture
- Pressure: The ROHO Dry Floatation insert protects the Coccyx and Ischia whilst the soft foam aids protection of the gluteal crease area
- Appropriate for clients with high-medium risk of ischemic ulcers and need for positioning and transfer support
- Soft polyurethane seating foam and neoprene rubber ROHO pad

DVA CONTRACTED (all codes)

AE04..... BUY

Prescribers... OT/Phys/RN/Ch/Ost/S/LMO

For approval rules refer to pg 7.

All models include

- 2 way stretch cover
- Hand Pump & Repair Kit
- Operating Instructions
- 24 Month Warranty



Nexus Spirit No Cover

WIDTH (Size")	DEPTH (Size")				
	18"	17"	16"	15"	14"
20"	PTC587300	(1)	(1)	(1)	(1)
18"	PTC587200	(1)	PTC587100	(1)	(1)
17"	(1)	PTC587000	(1)	(1)	(1)
16"	PTC586900	(1)	PTC586800	(1)	(1)
15"	(1)	(1)	(1)	PTC586700	(1)
14"	(1)	(1)	PTC586600	(1)	PTC586500

Note (1) This range can fit chairs from 14x14" (36x36cm) to 20x18" (51x46cm). Please contact Aidacare for inquiries relating to sizes outside of the displayed range.

Sizes listed are seat dimensions. The actual cushion is 1.5" longer to allow for the cushion to sit between the back canes.



ROHO® - Hybrid Elite

- Two trusted brands, one effective solution. The Hybrid Elite combines the skin protection and shape matching ability of ROHO Dry Floatation with a contoured foam base designed for ROHO by JAY
- The design allows for improved pelvic alignment and stability while maintaining optimal immersion and dispersion of pressure away from the pelvic area
- The stability provided by the JAY foam base also assists with achieving safer transfers.

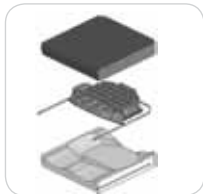

Hybrid Elite Cushion Assembly

All models include

- 2-way stretch cover
- Hand Pump & Repair Kit
- Operating Instructions
- 24 Month Warranty

WIDTH (Size")	DEPTH (Size")				
	20"	18"	17"	16"	15"
20"	PTC594951	PTC594950	(1)	(1)	(1)
18"	PTC594945	PTC594940	(1)	PTC594935	(1)
17"	(1)	(1)	PTC594930	(1)	(1)
16"	(1)	PTC594920	(1)	PTC594910	(1)
15"	(1)	(1)	(1)	PTC594900	PTC594899
14"	(1)	(1)	(1)	(1)	(1)

Note (1) This range fits a wide-range of chairs from 14x14" (35x35cm) to 24x20" (61x51cm). Please contact Aidacare for inquiries relating to sizes outside of the displayed range.

Sizes listed are seat dimensions. The actual cushion is ~1.5" longer to allow for the cushion to sit between the back canes.



High Profile



ROHO® Quadro Select

- ROHO Dry Floatation promotes circulation, and pressure relief whilst flexible neoprene cells reduce shear friction
- Quadro Select cushions employ ISOFLO Memory Control which locks air into compartments to help maintain better postural integrity in addition to pressure reduction
- Quick-and-easy air compartment adjustment maximizes function and utility

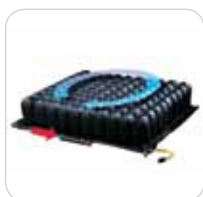

ISOFLO - Open



ISOFLO - Closed

High Profile (HP)

- 4" (10cm) High Cells
- Higher pressure disbursement

Low Profile (LP)

- 2" (5cm) High Cells
- Greater stability

All models include

- 2 way stretch cover
- Hand Pump & Repair Kit
- Operating Instructions
- 36 Month Warranty

(Also available in a Mid-profile version - contact Aidacare C.A.S.E)

WIDTH (Cells / Size")	Profile	DEPTH (Cells / Size")						
		12 / 22"	11 / 20"	10 / 18.5"	9 / 16.75"	8 / 15"	7 / 13"	6 / 11"
12 / 22"	HP	PTC589900	h	PTC589600	PTC589500	(1)	(1)	(1)
	LP	(1)	(1)	PTC589700	(1)	(1)	(1)	(1)
11 / 20"	HP	PTC589200	PTC589000	PTC588800	PTC589400	PTC589300	(1)	(1)
	LP	(1)	PTC589100	PTC588900	PTC589500	(1)	(1)	(1)
10 / 18.5"	HP	PTC588200	PTC588000	PTC587700	PTC588500	PTC588300	(1)	(1)
	LP	(1)	PTC588100	PTC587900	PTC588700	PTC588400	(1)	(1)
9 / 16.75"	HP	PTC592600	PTC592400	PTC592200	PTC593000	PTC592800	PTC592700	(1)
	LP	(1)	PTC592500	PTC592300	PTC593200	PTC592900	(1)	(1)
8 / 15"	HP	(1)	PTC591500	PTC591300	PTC592000	PTC591800	PTC591600	(1)
	LP	(1)	(1)	PTC591400	PTC592100	PTC591900	PTC591700	
7 / 13"	HP	(1)	(1)	(1)	PTC591200	PTC591000	PTC590700	(1)
	LP	(1)	(1)	(1)	(1)	PTC591100	PTC590800	
6 / 11"	HP	(1)	(1)	(1)	(1)	(1)	PTC590400	PTC590200
	LP	(1)	(1)	(1)	(1)	PTC590600	PTC590500	PTC590300

Note (1) This range can fit chairs from 12x12" (30x30cm) to 22x22" (55x55cm). Please contact Aidacare for sizes outside of the displayed range. Cells are referred to by Width then Depth.

L Low Risk **M** Medium Risk **H** High Risk **V** Very High Risk



ROHO® - Enhancer

- A unique combination of high(4”), mid(3”) and low(2”) profile cells in the one cushion centre the user and position the pelvis back in the wheelchair providing greater lateral stability through channelling of the legs
- A two-valve system allows the user to (1) adjust the interior “bucket” section for reduced pressure on the ischia and coccyx; and (2) adjust the outer perimeter for enhanced stability and positioning
- Appropriate for clients with high risk of ischemic ulcers and need for greater positioning support
- Soft neoprene construction is flame retardant and durable



DVA CONTRACTED (all codes)

AE04..... BUY
Prescribers... OT/Phys/RN/Ch/Ost/S/LMO

For approval rules refer to pg 7.

All models include

- 2 way stretch cover
- Hand Pump & Repair Kit
- Operating Instructions
- 36 Month Warranty

WIDTH (Cells / Size")	DEPTH (Cells / Size")				
	11 / 20"	10 / 18.5"	9 / 16.75"	8 / 15"	7 / 13"
11 / 20"	(1)	ENH1110C	(1)	(1)	(1)
10 / 18.5"	(1)	ENH1010C	PTC553100	(1)	(1)
9 / 16.75"	(1)	PTC553500	PTC553600	ENH98C	(1)
8 / 15"	(1)	(1)	PTC553400	PTC553300	(1)

Note (1) This range can fit chairs from 15x15" (38x38cm) to 19x19" (53x53cm). The entire standard range is shown in the table.

Custom made sizes are also available on request. Please contact Aidacare for sizes outside of the displayed range.

Consult with Aidacare's C.A.S.E.
(Custom And Specialised Equipment) team for this item.



ROHO® - Contour Select

- A unique combination of high(4”), mid(3”) and low(2”) profile cells in the one cushion centre the user and position the pelvis back in the wheelchair providing greater lateral stability through channelling of the legs
- ISOFLO Memory Control locks air into compartments to help maintain better postural integrity in addition to pressure reduction
- Interconnected cells help disburse pressure and reduce shear risk promoting pressure management
- Appropriate for clients with high risk of ischemic ulcers and need for greater positioning support
- Soft neoprene construction is flame retardant and durable



DVA CONTRACTED (all codes)

AE04..... BUY
(P.A Rqd for sizes > 10x10 cells)
Prescribers... OT/Phys/RN/Ch/Ost/S/LMO

For approval rules refer to pg 7.

All models include

- 2 way stretch cover
- Hand Pump & Repair Kit
- Operating Instructions
- 36 Month Warranty

WIDTH (Cells / Size")	DEPTH (Cells / Size")				
	11 / 20"	10 / 18.5"	9 / 16.75"	8 / 15"	7 / 13"
11 / 20"	PTC594000	PTC593900	(1)	(1)	(1)
10 / 18.5"	PTC593700	PTC593500	PTC593800	(1)	(1)
9 / 16.75"	PTC594400	PTC594300	PTC594700	PTC594600	PTC594500
8 / 15"	(1)	(1)	CS89C	PTC594100	(1)

Note (1) Custom made sizes are also available on request. Please contact Aidacare for sizes outside of the displayed range.

This range can fit chairs from 15x15" (38x38cm) to 21x21" (53x53cm).

Consult with Aidacare's C.A.S.E.
(Custom And Specialised Equipment) team for this item.



Contour Select Cover

REFER TO PAGE 320 FOR OUR
RANGE OF WHEELCHAIRS



L Low Risk **M** Medium Risk **H** High Risk **V** Very High Risk

DVA Contact Details
P 1300 888 052
F 1300 787 052
E dva@aidacare.com.au

General Enquiries
P 1300 133 120
E admin@aidacare.com.au
W www.aidacare.com.au





ROHO® - Single Compartment

- Offers all the benefits of ROHO Dry Floatation but with less postural control and flexibility than offered by the Dual Compartment and Quadro Select ranges
- Interconnected cells help disburse pressure and reduce shear risk promoting pressure management
- Appropriate for clients with high risk of ischemic ulcers.
- Soft neoprene construction is flame retardant and durable

✓ DVA CONTRACTED (all codes)

AE04.....BUY
(P.A Rqd for sizes > 11x9 cells)
Prescribers... OT/Phys/RN/Ch/Ost/S/LMO
For approval rules refer to pg 7.

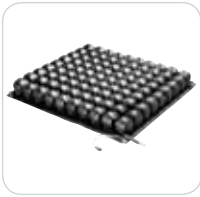

Low Profile Single Valve

High Profile (HP) **V Low Profile (LP) **H** All models include**

- 4" (10cm) High Cells
- Higher pressure disbursement
- 2" (5cm) High Cells
- Greater stability
- 2 way stretch cover
- Hand Pump & Repair Kit
- Operating Instructions
- 36 Month Warranty

WIDTH (Cells / Size")	Profile	DEPTH (Cells / Size")					
		12 / 22"	11 / 20"	10 / 18.5"	9 / 16.75"	8 / 15"	7 / 13"
12 / 22"	HP (1)	(1)	PTC544500	(1)	(1)	(1)	(1)
	LP PTC544600	(1)	PTC544550	(1)	(1)	(1)	(1)
11 / 20"	HP (1)	PTC544300	PTC544200	PTC544400	(1)	(1)	(1)
	LP (1)	PTC544350	PTC544250	(1)	(1)	(1)	(1)
10 / 18.5"	HP (1)	PTC543900	PTC543700	PTC544000	(1)	(1)	(1)
	LP (1)	(1)	PTC543800	PTC544100	(1)	(1)	(1)
9 / 16.75"	HP (1)	PTC546100	PTC545900	PTC546600	PTC546500	PTC546450	(1)
	LP (1)	PTC546200	PTC546000	PTC546700	(1)	(1)	(1)
8 / 15"	HP (1)	(1)	(1)	PTC545700	PTC545500	PTC545400	PTC545375
	LP (1)	(1)	PTC545300	PTC545800	PTC545600	(1)	PTC545377

Note (1) This range can be customised to fit any chair. The standard range fits chairs from 12x12" (30x30cm) to 24x24" (60x60cm). Please contact Aidacare for sizes outside of the displayed range. Cells are referred to by Width then Depth.



ROHO® - Dual Compartment

- Two separate compartments of the cushion allow positioning adjustments to address a pelvic obliquity (side-to-side) or sacral sitting (front to back).
- The Dual Compartment offers slightly less postural control and flexibility than the Quadro Select range but retains the pressure and shear risk management standard for ROHO.
- Appropriate for clients with high risk of ischemic ulcers.

✓ DVA CONTRACTED (all codes)

AE04.....BUY
Prescribers... OT/Phys/RN/Ch/Ost/S/LMO
For approval rules refer to pg 7.



Low Profile Dual Valve With Cover

High Profile (HP) **V Low Profile (LP) **H** All models include**

- 4" (10cm) High Cells
- Higher pressure disbursement
- 2" (5cm) High Cells
- Greater stability
- 2 way stretch cover
- Hand Pump & Repair Kit
- Operating Instructions
- 36 Month Warranty

WIDTH (Cells / Size")	Profile	DEPTH (Cells / Size")			
		10 / 18.5"	9 / 16.75"	8 / 15"	7 / 13"
10 / 18.5"	HP PTC547300	PTC547500	(1)	(1)	
	LP PTC547400	(1)	(1)	(1)	
9 / 16.75"	HP PTC548000	PTC548400	PTC548200	(1)	
	LP PTC548100	PTC548500	PTC548300		
8 / 15"	HP (1)	PTC547800	PTC547600	PTC547550	
	LP (1)	PTC547900	PTC547700	(1)	

Note (1) This range can be customised to fit any chair. The standard range fits chairs from 12x12" (30x30cm) to 24x24" (60x60cm). Please contact Aidacare for sizes outside of the displayed range. Cells are referred to by Width then Depth.





Synergy® Simplicity

- Tremendous comfort and moderate pressure management
- High-density polyurethane foam construction
- Exclusive wrap-and-lift design for pressure management
- Coccyx and sacral relief

✓ DVA CONTRACTED
 AE05..... BUY
 Prescribers... OT/Phys/Ch/Ost/RN/S/LMO
 For approval rules refer to pg 7.

- Four-way stretch, fluid resistant upper cover

Code	Chair Size (width x depth)	Height (inches)	Max. User Weight	Supplier Code	RAP #:
PTC601100	16 x 16"	3"	110kg	CUSASMB1547	AE05
PTC601200	18 x 16"	3"	110kg	CUSASMB1548	AE05
PTC601300	18 x 18"	3"	110kg	CUSASMB1549	AE05
PTC601400	20 x 18"	3"	110kg	CUSASMB1550	AE05



Synergy® Solution®

- Three-component design for pressure management, positioning and long-lasting comfort
- Exclusive wrap-and-lift design for pressure management
- Twin-cell gel insert
- Viscoelastic top layer

✓ DVA CONTRACTED
 AE04..... BUY
 Prescribers... OT/Phys/RN/Ch/Ost/S/LMO
 For approval rules refer to pg 7.

- 2-cover system to prevent shearing with interior liner

Code	Chair Size (width x depth)	Height (inches)	Max. User Weight	Supplier Code	RAP #:
PTC598500	10 x 10"	3"	110kg	CUSASMB1000	AE04
PTC598600	14 x 16"	3"	110kg	CUSASMB1005	AE04
PTC598700	16 x 16"	3"	110kg	CUSASMB1007	AE04
PTC598800	16 x 18"	3"	110kg	CUSASMB1008	AE04
PTC598850	16 x 20"	3"	110kg	CUSASMB1009	AE04
PTC599000	18 x 16"	3"	110kg	CUSASMB1010	AE04
PTC599100	18 x 18"	3"	110kg	CUSASMB1011	AE04
PTC599200	18 x 20"	3"	110kg	CUSASMB1012	AE04
PTC598900	20 x 16"	3"	110kg	CUSASMB1014	AE04
PTC599400	20 x 18"	3"	110kg	CUSASMB1015	AE04
PTC599500	20 x 20"	3"	110kg	CUSASMB1016	AE04
PTC599600	22 x 18"	3"	110kg	CUSASMB1019	AE04
PTC599610	24 x 18"	3"	110kg	CUSASMB1023	AE04



Synergy® Spectrum®

- Customized comfort and superb positioning and pressure management
- Extra deep well
- Choice of twin-cell lightweight fluid or viscoelastic foam insert
- Viscoelastic top layer
- 2-cover system to prevent shearing with interior liner

✓ DVA CONTRACTED
 AE04..... BUY
 Prescribers... OT/Phys/RN/Ch/Ost/S/LMO
 For approval rules refer to pg 7.

- 295 kg (650 lbs.) weight capacity with viscoelastic foam insert

Code	Chair Size (width x depth)	Height (inches)	Max. User Weight	Supplier Code	RAP #:
PTC599700	14 x 16"	3"	295 kg	USASMB1032	AE04
PTC599800	16 x 16"	3"	295 kg	USASMB1034	AE04
PTC599900	16 x 18"	3"	295 kg	USASMB1035	AE04
PTC600000	16 x 20"	3"	295 kg	USASMB1036	AE04
PTC600100	18 x 16"	3"	295 kg	USASMB1037	AE04
PTC600200	18 x 18"	3"	295 kg	USASMB1038	AE04
PTC600250	18 x 20"	3"	295 kg	USASMB1039	AE04
PTC600300	20 x 22"	3"	295 kg	USASMB1044	AE04
PTC600303	22 x 20"	3"	295 kg	USASMB1047	AE04

L Low Risk **M** Medium Risk **H** High Risk **V** Very High Risk



Otto Bock “Advantage” Cushions

- Antidecubitus wheelchair seat cushion
- Filled with Floam cells (Floam is a fluid polymeric gel)
- Contoured foam base with raised abduction area for improved individual seating position
- Foam cells are located where pressure relief is needed most

✓ DVA CONTRACTED
 AE04..... BUY
 Prescribers... OT/Phys/RN/Ch/Ost/S/LMO
 For approval rules refer to pg 7.

Code	Chair Size (width x depth)	Height (inches)	Supplier Code	RAP #:
PTC550150	18 x 18"	3"	AC1818	AE04
PTC550050	16 x 16"	3"	AC1616	AE04
PTC550075	16 x 18"	3"	AC1618	AE04
PTC550100	18 x 16"	3"	AC1816	AE04



Otto Bock “Cloud” Cushions

- Antidecubitus wheelchair seat cushion
- Filled with three different sizes of Floam cells (Floam is a fluid polymeric gel)
- Can be individually adapted according to the user's requirements by exchanging the cells
- Foam side cells provide additional support

✓ DVA CONTRACTED
 AE04..... BUY
 Prescribers... OT/Phys/RN/Ch/Ost/S/LMO
 For approval rules refer to pg 7.

- Targeted pressure relief, reduced shearing forces

Code	Chair Size (width x depth)	Height (inches)	Supplier Code	RAP #:
PTC549300	16 x 16"	4"	FFC1616	AE04
PTC549600	18 x 16"	4"	FFC1816	AE04
PTC549700	18 x 18"	4"	FFC1818	AE04
PTC549100	14 x 14"	4"	FFC1414	AE04
PTC549200	15 x 16"	4"	FFC1516	AE04
PTC549400	16 x 18"	4"	FFC1618	AE04
PTC549500	17 x 17"	4"	FFC1717	AE04
PTC549800	18 x 20"	4"	FFC1720	AE04
PTC549900	19 x 18"	4"	FFC1918	AE04
PTC549950	20 x 16"	4"	FFC2016	AE04
PTC550000	20 x 20"	4"	FFC2020	AE04

Other Otto Bock Cushions

Code	Description	Supplier Code	RAP #:
PTC551000	Evolight (Specify Size)	SK357	AE05
PTC550250	Contourgel (Specify Size)	SK302	AE04
PTC551010	Prevogel (Specify Size)	SK995	AE04

✓ DVA CONTRACTED
 AE04..... BUY
 Prescribers... OT/Phys/RN/Ch/Ost/S/LMO
 AE05..... BUY
 Prescribers... OT/Phys/Ch/Ost/RN/S/LMO
 For approval rules refer to pg 7.

L Low Risk **M** Medium Risk **H** High Risk **V** Very High Risk



Sunrise Medical - JAY Backrests Overview



SPECIFIC APPLICATIONS:

JAY CARE - 39° of angle adjustment to accommodate a kyphotic posture; J2 PLUS - 295 kg weight capacity; JAY PRECISION - Tension adjustable back w/ optional lateral supports & head rest

C.A.S.E (Custom And Specialised Equipment)

Where you see this symbol, the product you are looking at could be highly customisable. Please consult with your Aidacare C.A.S.E consultant for guidance on product selection and fitting before ordering.



Jay BASIC - pictured mounted

JAY - BASIC backrest

- Designed for the client with mild postural needs the JAY BASIC backrest replaces existing wheelchair upholstery and provides rigidity to the chair
- An off-the-shelf product, the JAY BASIC backrest is easily attached to wheelchair uprights with the mounting hardware included with the backrest
- The backrest can be reclined up to 8° and has three height positions to better tailor the solution to the user
- The backrest has a lightweight aluminium shell with a soft foam insert and breathable AirExchange cover
- Three different height sizes: Short (17.5") / Med (19.5") / Long (21.5") provide a more personalised fit

DVA CONTRACTED
 AP14..... BUY
 Prescribers... Phys/OT/Ch/Ost/S/LMO
 For approval rules refer to pg 7.

All models include

- Jay AirExchange cover
- Mounting hardware.
- 24mth Warranty (6mths on cover)

Aidacare Code	Supplier Code	Chair Width (range)	Cushion Width	Shell Height*	RAP #:
PTB532503	J3348	11.5 - 13.5"	11"	19.5"	AP14
PTB532504	J3360	13.5 - 15.5"	13"	21.5"	AP14
PTB532510	J3388	15.5 - 17.5"	15"	19.5"	AP14
PTB532505	J3308	17.5 - 19.5"	17"	19.5"	AP14

* Note: Each width size is available in a short (17.5") / med (19.5") or Long (21.5").

Note: Common sizes only are shown in the table. For sizes outside of the codes displayed, please contact your Aidacare C.A.S.E. consultant.



JAY - CARE backrest

- Designed for the client who has a fixed kyphotic posture, the JAY-CARE backrest provides solid back support to accommodate and slow-down back deformity
- The contoured design and 39° angle adjustability help further accommodate the multiple needs of the kyphotic client and make the JAY-CARE suitable to a client who has changing postural needs over time
- Soft & segmented foam contours to the spine and reduces peak pressure points
- Provides mild to moderate lateral support through the built-in lateral contour of the shell
- Optional foam wedges provide for a more customised fit

DVA CONTRACTED

AP14..... BUY

Prescribers... Phys/OT/Ch/Ost/S/LMO

For approval rules refer to pg 7..

All models include

- Universal mounting hardware
- 24mth Warranty

Aidacare Code	Supplier Code	Chair Width	Cushion Width	Shell Height	RAP #:
(1)	J3500B	14"	11.5"	16.5"	AP14
PTB532530	J3505B	16"	13.5"	17.5"	AP14
PTB532520	J3500B	18"	14.5"	19.0"	AP14
PTB532515	J33502B	20"	15.5"	20.5"	AP14

Note: Common sizes only are shown in the table. For sizes outside of the codes displayed, please contact your Aidacare C.A.S.E. consultant.



Jay J2 with lateral supports

JAY - J2 & J2 Tall backrest

- Designed for the client who has minimal to moderate postural needs that may change over time.
- The lightweight contoured aluminium shell and contoured foam insert along with 15° of tilt and height adjustability replace the standard wheelchair back upholstery
- J2 provides excellent posterior pelvis stabilisation and posterior thoracic support.
- Standard with Lumbar shims, Mounting hardware and an AirExchange cover, the J2 also has multiple compatible options such as Swing-away trunk supports; Offset hardware kits; and Fluid pads to reduce spinal pressure points
- Lightweight and easily removable for transportation

DVA CONTRACTED

AP14..... BUY

Prescribers... Phys/OT/Ch/Ost/S/LMO

For approval rules refer to pg 7..

Consult with Aidacare's C.A.S.E.
(Custom And Specialised Equipment) team for this item.

All models include

- Universal mounting hardware
- Jay AirExchange cover
- Lumbar Shims
- 24mth Warranty (6mths on cover)



Jay J2 Tall Back

J2 Tall

- The J2 Tall is designed for the taller client with a need for longer trunk support without interfering with upper limb functional activities
- Provides more aggressive lateral support than the standard J2

Aidacare Code	Supplier Code	Chair Width*	J2 / J2T	Cushion Width	Shell Height	RAP #:
PTB532260	2512K	9 - 10"	J2	8.5"	12.5"	AP14
PTB532265	2513K	10 - 11"	J2	10"	13"	AP14
PTB532270	2514K	11 - 12"	J2	11"	14.5"	AP14
PTB532280	2514TK		J2T	10.5"	21"	AP14
PTB532290	2515K	12 - 13"	J2	12"	16.5"	AP14
PTB532300	2515TK		J2T	12"	23"	AP14
PTB532310	2516K	13 - 14"	J2	12.5"	16.5"	AP14
PTB532320	2516TK		J2T	12.5"	23"	AP14
PTB532330	2517K	14 - 15"	J2	13.5"	16.5"	AP14
PTB532340	2517TK		J2T	13.5"	23"	AP14
PTB532350	2518K	15 - 16"	J2	14.5"	16.5"	AP14
PTB532360	2518TK		J2T	14"	23"	AP14
PTB532370	2519K	16 - 17"	J2	15.5"	16.5"	AP14
PTB532380	2519TK		J2T	15.5"	23"	AP14
PTB532390	2520K	17 - 18"	J2	16"	16.5"	AP14
PTB532400	2520TK		J2T	16"	23"	AP14

Note 1: The J2 & J2 Tall are available in a wide range of sizes. Common sizes only are shown in the table. For sizes outside of the codes displayed, please contact your Aidacare C.A.S.E. consultant.

* Chair width dimensions are taken inside back canes.



JAY - J2 Deep Contour backrest

- Designed for the client who has moderate postural needs who needs a lightweight, easy-to-use back support that provides both pelvic and trunk positioning
- Multiple positioning accessories; height adjustability and tilt of up to 15° allow the J2 DC backrest to alter in accordance with the client's changing needs over time
- Deep lateral walls provide excellent lateral trunk stability whilst the shape and size of the backrest minimises upper limb interference and don't compromise seat depth

✓ DVA CONTRACTED
AP14..... BUY
Prescribers... Phys/OT/Ch/Ost/S/LMO
For approval rules refer to pg 7..

Consult with Aidacare's C.A.S.E.
(Custom And Specialised Equipment) team for this item.

- 1 Adjustable posterior/lateral pelvic shims help stabilise the pelvis.
- 2 Adjustable posterior pelvic support contours the foam and positions the pelvis.
- 3 Adjustable lateral support shims gently hug the body for increased trunk stability.

All models include

- Universal mounting hardware
- Jay AirExchange cover
- 2 lateral support wedges
- 24mth Warranty (6mths on cover)
- 2 posterior pelvic supports

Aidacare Code	Supplier Code	Chair Width*	Cushion Width	Shell Height	RAP #:
PTB532180	J2314	12 - 13"	9"	17"	AP14
PTB532190	J2315	13 - 14"	10"	18.5"	AP14
PTB532200	J2316	14 - 15"	11.5"	18.5"	AP14
PTB532210	J2317	15 - 16"	12"	18"	AP14
PTB532220	J2318	16 - 17"	13"	18"	AP14
PTB532230	J2319	17 - 18"	14"	18"	AP14
PTB532240	J2320	18 - 19"	15"	18"	AP14

Note 1: The J2 DC is available in a wide range of sizes. Common sizes only are shown in the table. For sizes outside of the codes displayed, please contact your Aidacare C.A.S.E. consultant.

* Chair width dimensions are taken inside back canes.



JAY - FOCUS POINT

- Designed for the client who has moderate to high postural needs who needs an easy-to-use back support that provides both posterior pelvic and lateral positioning that will change over time.
- Featuring back height adjustment of 4"; Forward tilt (20°); Rear tilt (45°); and multiple optional positioning supports, the JAY FOCUS provides the flexibility to adapt to the changing needs of the client.
- The three-piece contoured design features a rib-reinforced contoured aluminium shell and two multi-adjustable lateral wings.
- The shape of the JAY FOCUS minimises upper limb interference.
- The three piece design includes a back shell, two adjustable lateral wings, foam pelvic wedge, universal headrest mounting plate and clamp.

✓ DVA CONTRACTED
AP14..... BUY
Prescribers... Phys/OT/Ch/Ost/S/LMO
For approval rules refer to pg 7.

Consult with Aidacare's C.A.S.E.
(Custom And Specialised Equipment) team for this item.

All models include

- 24mth Warranty (6mths on cover)

Aidacare Code	Supplier Code	Chair Width	Cushion Width	Shell Height	RAP #:
(1)	JFPB1415	14 - 15"	9"	14"	AP14
(1)	JFPB1415(T)	14 - 15"	9"	17"	AP14
PTB532690	JFPB1617	16 - 17"	11"	15"	AP14
PTB532700	JFPB1617(T)	16 - 17"	11"	18"	AP14
PTB532710	JFPB1819	18 - 19"	13"	16"	AP14
PTB532720	JFPB1819(T)	18 - 19"	13"	19"	AP14
(1)	JFPB2021	20 - 21"	15"	17"	AP14
PTB532725	JFPB2021(T)	20 - 21"	15"	20"	AP14

Note: Each size group is available as a Regular or Tall (T)

Note: The JAY FOCUS POINT is available in a wide range of sizes. Common sizes only are shown in the table. For sizes outside of the codes displayed, please contact your Aidacare C.A.S.E. consultant.



JAY - J3 TOP SELLER

The new Jay-J3 series of backrests are highly customisable to suit your client's needs.

Customisations cover 6 spectrums: (1) Contour Depth; (2) Level of Support; (3) Back Support Height; (4) Backrest Width; (5) Mounting Hardware; (6) Optional modular accessories. Various options within each spectrum create an enormously flexible package.

We strongly recommend that you consult with your Aidacare C.A.S.E team member for any inquiries relating to these cushions. Refer: C.A.S.E overview on pg 13)

✔ **DVA CONTRACTED**

AP14..... BUY

Prescribers... Phys/OT/Ch/Ost/S/LMO

For approval rules refer to pg 7..

Consult with Aidacare's C.A.S.E.
(Custom And Specialised Equipment) team for this item.



- The new JAY J3 back is the most versatile hardware package, flexible positioning system, and all-in-one package in the JAY range.
- The J3 Back is dedicated to eliminating compromises when different products are bundled. J3 ensures compatibility between solutions by encompassing a huge array of options within the one range.
- The J3 Back features one of the widest ranges of available accessories. Multiple lateral sizes, Spine-Align positioning components, Whitmyer® headrests, Comfort Fit® chest straps, and trunk straps are an example of some of the available options.
- Every J3 back features special new spacer fabric upholstery designed to wick moisture away from the skin and circulate air flow throughout the cover.
- 135kg capacity on standard models and 230kg in models over 22".
- The J3 back provides up to 22° of back angle adjustment with minimal to zero loss of seat depth. This is especially helpful for individuals with postural deformities who may require more extreme angles.
- Fitting the back to the user not the user to the back is the goal of the Spine-Align Posture Conforming system. This is accomplished by combining a wide range of individual foam components to create unique shapes that optimize postural support, evenly distribute pressure, and maximize function. Velcro strips attach to each shape so they can be placed into hundreds of configurations. The flexibility of the system is boundless.

J3 Contour Depth Profile

J3 Range of Trunk Support



Otto Bock
QUALITY FOR LIFE

Otto Bock - Backster

- Easily demountable one-hand release-back system
- Individually adaptable, five-piece padding with velcro connection to suit user requirements
- Stable back shell made of Aluminium
- Can be mounted on nearly all commercially available wheelchairs
- Available in 3 key back-width sizes

Supplier Code	Padding	Seat Width Range	Back Width	Back Height	Contour Depth	Weight
481D00=SV640	SV625	38 - 42 cm	38 cm	45 cm	11 cm	1.7 kg
481D00=SK644	SV655	42 - 46 cm	42 cm	50 cm	12 cm	2.3 kg
481D00=SK648	SV670	46 - 50 cm	46 cm	55 cm	13 cm	2.8 kg



Synergy® Seating System

The Quantum® Synergy® Seating System offers a clean, streamlined appearance and ease of adjustment. The seating system's unique design allows for height, width, depth and back angle adjustments to be made quickly and easily in the field. The Synergy Seat interfaces with most types of seat and back cushions, and was designed to be highly user-friendly.



Features:

- Easily adjustable and versatile design that can grow with the client
- Easy customization
- Several width/depth adjustment packages ranging from 10" to 24"
- Accepts a wide variety of after-market seats and backs
- Heavy Duty option provides a weight capacity of 650 lbs. and seating up to 32"x 28" (model specific)



Synergy® Manual Tilt

- 95-168° of recline
- 300 lbs. weight capacity
- Does not increase seat-to-floor height
- Standard shear reduction and reclining armrests
- Available with TRU-Balance Power Tilt and TRU-Balance Lift & Tilt



Synergy® Manual Recline

- Delivers 10" of elevation with 50° of tilt
- Four-point mount lift for maximum stability, low seat-to-floor heights and the use of maximum capacity batteries
- Maximum versatility and ease of adjustment
- Available with power recline, power front riggings and TRU-Comfort Seating
- 300 lbs. weight capacity

Matrix Backrest System

The Matrix Backrest is a specialised backrest system that can be set up to the shape of the client's back. The segmented structure gives greater comfort, function and corrective postural manageability within a wheelchair. The backrest is dynamic and moves with the user by absorbing shock and being flexible. Shape adjustments can be made directly whilst the user is seated, improving fit quality to ensure that it can be easily changed if the user requirements alter.



Code	Description	Seat Width	Backrest Height	Warranty	Max. User Weight
PTB534100	Matrix Backrest Size 1	350 mm	480 mm	12 months	110 kg
PTB534150	Matrix Backrest Size 2	380 mm	500 mm	12 months	110 kg
PTB534200	Matrix Backrest Size 3	400 mm	530 mm	12 months	110 kg
PTB534250	Matrix Backrest Size 4	430 mm	560 mm	12 months	110 kg
PTB534300	Matrix Backrest Size 5	450 mm +	580 mm	12 months	110 kg
PTB534350	Matrix Backrest Cover Size 1	350 mm	480 mm	12 months	-
PTB534400	Matrix Backrest Cover Size 2	380 mm	500 mm	12 months	-
PTB534450	Matrix Backrest Cover Size 3	400 mm	530 mm	12 months	-
PTB534500	Matrix Backrest Cover Size 4	430 mm	560 mm	12 months	-
PTB534550	Matrix Backrest Cover Size 5	450 mm +	580 mm	12 months	-

C.A.S.E (Custom And Specialised Equipment)

Where you see this symbol, the product you are looking at could be highly customisable. Please consult with your Aidacare C.A.S.E consultant for guidance on product selection and fitting before ordering.



Shape GP



Consult with Aidacare's C.A.S.E.
(Custom And Specialised Equipment)
team for this item.

The lightweight Synergy® Shape GP general purpose wheelchair back cushion delivers long-lasting support and exceptional positioning via a contoured design. The unique two-point connection hardware makes removal and adjustment fast and effortless while providing a very solid connection for a secure, rigid feel.

Features:

- Quick and easy installation on 2.2 cm (7/8") and 2.5 cm (1") diameter back canes
- Two-point hardware allows for easy removal and provides solid, rigid attachment to chair
- Wraparound cover keeps back cushion from shifting position
- Angle adjustment of 10 to -10 degrees and 5 cm (2") depth adjustment with client in chair
- High-density foam base to prevent bottom out
- Contoured to help maintain proper positioning

Shape



Consult with Aidacare's C.A.S.E.
(Custom And Specialised Equipment)
team for this item.

The Synergy® Shape Back has new features like an enhanced wraparound cover and two-point quick-release levers for easy depth and angle adjustment, even while occupied. Available in standard, low and tall back heights, the Shape utilizes a unique contoured design and dual-layer foam construction with viscoelastic foam top layer to offer exceptional comfort, support and pressure management.

Features:

- Ergonomically contoured
- High-density base foam with a soft viscoelastic upper layer
- Four-way stretch cover overlaps back pan
- Choice of mounting hardware: Two-point, quick-release or four-point, bolt on hardware for use with TRU-Balance® Power Positioning and Synergy® Seat Frame Systems
- Angle adjustment of 57 to -33 degrees and 5 cm (2") depth adjustment with client in chair
- Available in standard (48 cm (19")), low (41 cm (16")) and tall (58 cm (23")) back heights
- Accommodates an array of headrests and accessories

Shape Deep Contour



Consult with Aidacare's C.A.S.E.
(Custom And Specialised Equipment)
team for this item.

The Shape Deep Contour features fully adjustable, gel-covered thoracic lateral supports and dual-layer foam construction with a viscoelastic foam top layer for pressure management and comfort. It is an exceptional choice for those who desire superior comfort and support.

Features:

- Fully adjustable, 7" (H) x 6" (D), gel-covered thoracic lateral supports
- Quick and easy installation on 2.2 cm (7/8") and 2.5 cm (1") diameter back canes
- Choice of mounting hardware: Two-point, quick-release or four-point, bolt on hardware for use with TRU-Balance® Power Positioning and Synergy® Seat Frame Systems
- Angle adjustment of 57 to -33 degrees and 5 cm (2") depth adjustment with client in chair
- High-density foam base with viscoelastic foam top layer to prevent bottom out
- Wraparound cover keeps back cushion from shifting position
- Available in standard (48 cm (19")) and tall (58 cm (23")) back heights



Wheelchair Carrier

- Lightweight, removable carrier is mounted to the tow ball of a car
- Can be removed and folded away for convenient storage
- Available for self propelled or transit wheelchairs

DVA For eligibility & prescriber info please refer to pg 7.

Code	Description	Width	Depth	Height	Product Wt.	Max. Carrying Wt.	RAP #:
WCA858480	Wheelchair Carrier Self Propelled	700 mm	200 mm	550 mm	9 kg	45 kg	AP14
WCA858490	Wheelchair Carrier Transit	700 mm	200 mm	550 mm	9 kg	45 kg	AP14



Combination Headrest

- The combination headrest is a supportive headrest designed to provide extra lateral support to the user
- Made of polyurethane it can be cleaned with gentle soap, a sponge and water
- Requires headrest hardware for wheelchair mounting

Code	Description	Width	Height
WCA858700	Combination Headrest	220 mm	130 mm



Soft Headrest

- Designed for superior comfort and support the Otto Bock soft headrest consists of an ABS plastic shell, memory foam and removable lycra cover
- Covers available separately



Headrest Hardware

- This headrest hardware provides the ultimate fitting for our headrest range
- Featuring a large range of adjustability through easy to use levers, the headrest hardware allows for precise fitting of headrests to user requirements

Notes: Picture shows Headrest Hardware in silver.

Code	Description	Width	Height	Code	Description
WCA858810	Soft Headrest Small	190 mm	150 mm	WCA859380	Offset Multi Axis Black
WCA858800	Soft Headrest Large	280 mm	190 mm	WCA859390	Straight Multi Axis Black



Gel Armrest Pads

- These gel armrest pads are designed to offer the ultimate in comfort and protection to the elbows and wrists
- Incorporating a latex-free, solid gel these armrest pads have a durable neoprene nylon surface
- Additionally they offer the ultimate in comfort, making them the best in interface products.



Stayflex Anterior Trunk Support no zipper

- Provides dynamic upper body support and unparalleled comfort
- Stabilizing lower panel to limit stretching and "riding up"
- Elastic, padded material allows comfortable, controlled movement

DVA For eligibility & prescriber info please refer to pg 7.

Code	Description	Unit	Width	Length	Code	Description	RAP #:
PTA508400	Gel Armrest Pads	Pair	88.9 mm	304.8 mm	WCA860524	W'Chair Harness - Stayflex No Zipper - Lge	AP14
PTA508425	Gel Armrest Pads	Pair	88.9 mm	355.6 mm	WCA860522	W'Chair Harness - Stayflex No Zipper - Med	AP14
PTA508450	Gel Armrest Pads	Pair	88.9 mm	406.4 mm	WCA860520	W'Chair Harness - Stayflex No Zipper - Sml	AP14
					WCA860526	W'Chair Harness - Stayflex No Zipper - XL	AP14



Stayflex Anterior Trunk Support with zipper

- Provides dynamic upper body support and unparalleled comfort
- Elastic, padded material allows comfortable, controlled movement
- Front zipper for easy access



Leg Harness

- Holds each leg at the inner thigh providing efficient resistance to pelvic rotation and obliquity
- No pressure on the bladder
- Convenient pull straps for adjustment

DVA For eligibility & prescriber info please refer to pg 7.

Code	Description	RAP #:
WCA860514	Stayflex w/zipper Large Flat Mount	AP14
WCA860512	Stayflex w/zipper Medium Flat Mount	AP14
WCA860510	Stayflex w/zipper Small Flat Mount	AP14
WCA860516	Stayflex w/zipper Extra Large Flat Mount	AP14

DVA For eligibility & prescriber info please refer to pg 7.

Code	Description	RAP #:
WCA860421	Leg Harness Large 380 mm (Fits 14"-16" Seat Width)	AP14
WCA860420	Leg Harness Medium 330 mm (Fits 11"-14" Seat Width)	AP14
WCA860419	Leg Harness Small 230 mm (Fits 8"-11" Seat Width)	AP14



Pelvic Positioning Belt with Metal Push Button 2 Point

- Two points of attachment to wheelchair
- Suitable for supporting users with low tone or weakness
- Metal Push button for secure fit
- Single pull strap for convenient adjustment

DVA For eligibility & prescriber info please refer to pg 7.

Code	Description	RAP #:
WCA860129	Centre Pull 2 Point Large Frame Saver Flat Mount	AP14
WCA860125	Centre Pull 2 Point Medium Frame Saver Flat Mount	AP14
WCA860121	Centre Pull 2 Point Small Frame Saver Flat Mount	AP14
WCA860117	Centre Pull 2 Point XS Frame Saver Flat Mount	AP14



Pelvic Positioning Belt with Metal Push Button 4 Point

- Four points of attachment to the wheelchair
- Holds pelvis more aggressively for situations when user has a lot of movement
- Metal Push button for secure fit
- Single pull strap for convenient adjustment

DVA For eligibility & prescriber info please refer to pg 7.

Code	Description	RAP #:
WCA860241	Centre Pull 4 Point Large Frame Saver Flat Mount	AP14
WCA860233	Centre Pull 4 Point Small Frame Saver Flat Mount	AP14
WCA860229	Centre Pull 4 Point XS Frame Saver Flat Mount	AP14
WCA860237	Centre Pull 4 Point Medium Frame Saver Flat Mount	AP14



Push Button Security Cover

- Durable covers snap securely onto metal push-button buckles
- Limits user access to release the belt
- Opens instantly with a pen tip

DVA For eligibility & prescriber info please refer to pg 7.

Code	Description	RAP #:
WCA860412	Security Cover for 1-1/2" Buckles	AP14
WCA860413	Security Cover for 2" Buckles	AP14



Pelvic Positioning Belts with Rehab Latch 2 Point

- Two points of attachment to wheelchair
- Suitable for supporting users with low tone or weakness
- Rehab Latch for easy latch release
- Single pull strap for convenient adjustment

DVA For eligibility & prescriber info please refer to pg 7.

Code	Description	RAP #:
WCA860177	Centre Pull 2 Point Large Frame Saver Flat Mount	AP14
WCA860173	Centre Pull 2 Point Medium Frame Saver Flat Mount	AP14
WCA860169	Centre Pull 2 Point Small Frame Saver Flat Mount	AP14



Pelvic Positioning Belt with Rehab Latch 4 Point

- Four points of attachment to the wheelchair
- Holds pelvis more aggressively for situations when user has a lot of movement
- Rehab Latch for easy latch release
- Single pull strap for convenient adjustment

DVA For eligibility & prescriber info please refer to pg 7.

Code	Description	RAP #:
WCA860385	Centre Pull 4 Point Small Frame Saver Flat Mount	AP14
WCA860393	Centre Pull 4 Point Large Frame Saver Flat Mount	AP14
WCA860389	Centre Pull 4 Point Medium Frame Saver Flat Mount	AP14



Pelvic Positioning Belt Non Padded

- Non padded pelvic positioning belt
- Secure metal push button attachment
- Single pull strap for convenient adjustment

DVA For eligibility & prescriber info please refer to pg 7.

Code	Description	RAP #:
WCA860365	Centre Pull 2 Point Large Frame Saver Flat Mount	AP14
WCA860361	Centre Pull 2 Point Medium Frame Saver Flat Mount	AP14



Shoulder Harness Rear Pull

- Provides dynamic shoulder and trunk support
- Laminar Pad construction distributes pressure broadly across shoulders and sternum
- Easy, convenient front adjustment and release

DVA For eligibility & prescriber info please refer to pg 7.

Code	Description	RAP #:
WCA860472	Shoulder Harness Large Flat Mount	AP14
WCA860470	Shoulder Harness Medium Flat Mount	AP14
WCA860468	Shoulder Harness Small Flat Mount	AP14
WCA860474	Shoulder Harness Extra Large Flat Mount	AP14



Power Wheelchair Tray

- A perspex tray to suit most model power wheelchairs
- It features a unique swing away bracket that allows the tray to be out of the way during transfers

Code	Description	Fits Chair
MSP419310	Power Wheelchair Tray	16"
MSP419320	Power Wheelchair Tray	18"
MSP422470	Power Wheelchair Tray	20"



Monoflex Anterior Trunk Support

- Dynamic chest belt provides lateral and anterior support at the chest or abdominal level
- Soft, comfortable neoprene provides the perfect mix of stretch plus support
- Side release buckles allow closure / adjustment on both sides for greater convenience
- Mounting hardware for sling or solid backs included

DVA CONTRACTED
 AE04..... BUY
 Prescribers... OT/Phys/RN/Ch/Ost/S/LMO
 For approval rules refer to pg 7.

Code	Description	Width	Length	RAP #:
WCA860546	Monoflex Extra Small	76 mm	318 mm	AP04
WCA860547	Monoflex Small	89 mm	397 mm	AP04
WCA860548	Monoflex Medium	102 mm	476 mm	AP04
WCA860549	Monoflex Large	114 mm	556 mm	AP04
WCA860550	Monoflex Extra Large	127 mm	635 mm	AP04



Calf Panel

- Aeromesh TM fabric allows for air circulation and provides comfortable support surface for legs
- Designed to attach to legrest hangers of wheelchairs for lower leg support



Calf Strap

- Aeromesh TM fabric allows for air circulation and provides comfortable support strap for legs
- Designed to attach to legrest hangers of wheelchairs for lower leg support

DVA For eligibility & prescriber info please refer to pg 7.

Code	Description	Length	RAP #:
WCA860459	Calf Panel Small (Fits 12"-15" Seat Width)	800 mm	AP14
WCA860461	Calf Panel Medium (Fits 15"-19" Seat Width)	900 mm	AP14
WCA860463	Calf Panel Large (Fits 19"-22" Seat Width)	1000 mm	AP14

DVA For eligibility & prescriber info please refer to pg 7.

Code	Description	Length	RAP #:
WCA860464	Calf Strap Small (Fits 13"-15" Seat Width)	800 mm	AP14
WCA860465	Calf Strap Medium (Fits 15"-18" Seat Width)	900 mm	AP14
WCA860466	Calf Strap Large (Fits 18"-22" Seat Width)	1000 mm	AP14



Footplate Protectors

- Provide a soft cushioning cover for hard wheelchair footplates
- Covers fully encase the footplates to support and protect patient, even when footplates are raised



Foot Positioners

- Provide supportive positioning for the wheelchair users feet
- Durable ABS plastic construction
- Mount directly to footplate on a wheelchair
- Velcro adjustment for securing
- Available in a range of sizes

DVA For eligibility & prescriber info please refer to pg 7.

Code	Description	RAP #:
WCA859275	Foot Plate Protectors	AP14

DVA For eligibility & prescriber info please refer to pg 7.

Code	Description	RAP #:
WCA859280	Foot Positioners Small	AP14
WCA859290	Foot Positioners Medium	AP14
WCA859300	Foot Positioners Large	AP14
WCA859310	Foot Positioners Extra Large	AP14



Channel Forearm Pad

- These Channel Forearms (gutter arms) are a modular system designed to provide functional support for patients with weakness or paralysis of the upper extremities
- Every forearm and hand pad combination can be directly mounted on the wheelchair armrest and on the elevating swivel unit for armrests



Ankle Huggers Velcro Attachment & Mtg. Kit

- Provide supportive positioning for the wheelchair users ankles and feet
- Secure velcro attachments to assist in foot and leg positioning
- Come with mounting kit for attachment to footplates

DVA For eligibility & prescriber info please refer to pg 7.

Code	Description	Length	Width	Code	Description	RAP #:
WCA859000	Channel Forearm Pad Small	205 mm	105 mm	WCA860422	Ankle Huggers Velcro Attach. Extra Small	AP14
WCA858990	Channel Forearm Pad Medium	290 mm	120 mm	WCA860423	Ankle Huggers Velcro Attach. Small	AP14
WCA858980	Channel Forearm Pad Large	355 mm	120 mm	WCA860424	Ankle Huggers Velcro Attach. Medium	AP14
WCA859010	Channel Forearm Pad One Piece (no hand pad req.)	460 mm	120 mm	WCA860425	Ankle Huggers Velcro Attach. Large	AP14
				WCA860426	Ankle Huggers Velcro Attach. Extra Large	AP14

Wheelchairs & Seating



About this Catalogue

Due care has been taken to ensure all the information contained in this catalogue is correct at the time of printing. All measurements, pictures, colours and weight capacities are to be used as a guide only. Our suppliers reserve the right to modify the design or appearance of any product displayed in this catalogue without prior notice.

© Copyright Aidacare Pty Ltd 2011 Version 1.0

No part of this catalogue may be copied, distributed, reproduced, scanned or stored on any electronic database, whether in whole or in part in any form or by any means.